

Bleacher Sight Line & Space Calculation

Code (for illustration and space charts)

- "A" Depth of gymnasium seating extended
- "B" Depth of gymnasium seating closed
- "C" Height of unit (top row seat height)
- "D" Balcony height
- "E" Wall Tie height

S = Seat spacing (22", 24", 26", 30", 32", or 33")
 R = Rise (10 1/4" or 11 1/2")

Table of Dimensions (metric equivalents in centimeters)

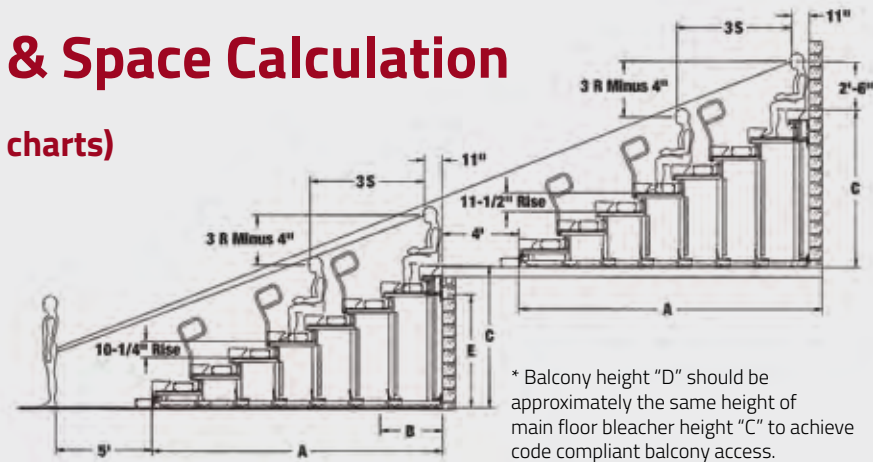

* Balcony height "D" should be approximately the same height of main floor bleacher height "C" to achieve code compliant balcony access.

No.	Extended Dimension (Forward-Fold*)						Seatboard Height**	Wall Tie Height**	Seatboard Height**	Wall Tie Height**
	22" Span (56 cm)	24" Span (61 cm)	26" Span (66 cm)	30" Span (76 cm)	32" Span (82 cm)	33" Span (84 cm)	"C"	"E"	"C"	"E"
	Ft. (cm)	Ft. (cm)	Ft. (cm)	Ft. (cm)	Ft. (cm)	Ft. (cm)	10-1/4"(26cm) Rise	10-1/4"(26cm) Rise	11-1/2"(29cm) Rise	11-1/2"(29cm) Rise
3	5'-1/2" (154)	5'-2-1/2" (159)	5'-6-1/2" (170)	6'-6-1/4" (199)	6'-8-1/4" (204)	6'-9-1/4" (207)	3'-1" (94)	1'-7" (48)	3'-4-3/4" (103)	1'-9-1/2" (55)
4	6'-10-1/2" (210)	7'-2-1/2" (220)	7'-8-1/2" (236)	9'-1/4" (275)	9'-4-3/16" (285)	9'-6-1/4" (291)	3'-11-1/4" (120)	2'-5-1/4" (74)	4'-4-1/4" (132)	2'-9" (84)
5	8'-8-1/2" (266)	9'-2-1/2" (281)	9'-10-1/2" (302)	11'-6-1/4" (352)	12-3/16" (367)	12'-3-1/4" (374)	4'-9-1/2" (146)	3'-3-1/2" (100)	5'-3-3/4" (161)	3'-8-1/2" (113)
6	10'-6-1/2" (322)	11'-2-1/2" (342)	12'-1/2" (368)	14'-1/4" (428)	14'-8-3/16" (448)	15'-1/4" (458)	5'-7-3/4" (172)	4'-1-3/4" (126)	6'-3-1/4" (191)	4'-8" (142)
7	12'-4-1/2" (378)	13'-2-1/2" (403)	14-2-1/2" (434)	16'-6-1/4" (504)	17'-4-3/16" (529)	17'-9-1/4" (542)	6'-6" (198)	5'-0" (152)	7'-2-3/4" (220)	5'-7-1/2" (171)
8	14'-2-1/2" (434)	15'-2-1/2" (464)	16'-4-1/2" (500)	19'-1/4" (580)	20'-3/16" (611)	20'-6-1/4" (626)	7'-4-1/4" (224)	5'-10-1/4" (178)	8'-2-1/4" (249)	6'-7" (201)
9	16'-1/2" (490)	17'-2-1/2" (525)	18'-6-1/2" (566)	21'-6-1/4" (656)	22'-8-3/16" (692)	23'-3-1/4" (710)	8'-2-1/2" (250)	6'-8-1/2" (204)	9'-1-3/4" (278)	7'-6-1/2" (230)
10	17'-10-1/2" (546)	19'-2-1/2" (586)	20'-8-1/2" (632)	24'-1/4" (733)	25'-4-3/16" (773)	26'-1/4" (793)	9'-0-3/4" (276)	7'-6-3/4" (230)	10'-1-1/4" (308)	8'-6" (259)
11	19'-8-1/2" (601)	21'-2-1/2" (647)	22'-10-1/2" (698)	26'-6-1/4" (809)	28'-3/16" (854)	28'-9-1/4" (877)	9'-11" (302)	8'-5" (256)	11'-0-3/4" (337)	9'-5-1/2" (288)
12	21'-6-1/2" (657)	23'-2-1/2" (708)	25'-1/2" (764)	29'-1/4" (885)	30'-8-3/16" (936)	31'-6-1/4" (961)	10'-9-1/4" (328)	9'-3-1/4" (283)	12'-0-1/4" (366)	10'-5" (317)
13	23'-4-1/2" (713)	25'-2-1/2" (769)	27'-2-1/2" (830)	31'-6-1/4" (961)	33'-4-3/16" (1017)	34'-3-1/4" (1045)	11'-7-1/2" (354)	10'-1-1/2" (309)	12'-11-3/4" (395)	11'-4-1/2" (347)
14	25'-2-1/2" (769)	27'-2-1/2" (830)	29'-4-1/2" (896)	34'-1/4" (1037)	36'-3/16" (1098)	37'-1/4" (1129)	12'-5-3/4" (380)	10'-11-3/4" (335)	13'-11-1/4" (424)	12'-4" (376)
15	27'-1/2" (825)	29'-2-1/2" (891)	31'-6-1/2" (962)	36'-6-1/4" (1114)	38'-8-3/16" (1180)	39'-9-1/4" (1213)	13'-4" (406)	11'-10" (361)	14'-10-3/4" (454)	13'-3-1/2" (405)
16	28'-10-1/2" (881)	31'-2-1/2" (952)	33'-8-1/2" (1028)	39'-1/4" (1190)	41'-4-3/16" (1261)	42'-6-1/4" (1296)	14'-2-1/4" (432)	12'-8-1/4" (387)	15'-10-1/4" (483)	14'-3" (434)
17	30'-8-1/2" (937)	33'-2-1/2" (1013)	35'-10-1/2" (1094)	41'-6-1/4" (1266)	44'-3/16" (1342)	45'-3-1/4" (1380)	15'-0-1/2" (458)	13'-6-1/2" (413)	16'-9-3/4" (512)	15'-2-1/2" (463)
18	32'-6-1/2" (993)	35'-2-1/2" (1074)	38'-1/2" (1160)	44'-1/4" (1342)	46'-8-3/16" (1423)	48'-1/4" (1464)	15'-10-3/4" (484)	14'-4-3/4" (439)	17'-9-1/4" (541)	16'-2" (493)
19	34'-4-1/2" (1048)	37'-2-1/2" (1135)	40'-2-1/2" (1226)	46'-6-1/4" (1418)	49'-4-3/16" (1505)	50'-9-1/4" (1548)	16'-9" (510)	15'-3" (465)	18'-8-3/4" (570)	17'-1-1/2" (522)
20	36'-2-1/2" (1104)	39'-2-1/2" (1196)	42'-4-1/2" (1292)	49'-1/4" (1495)	52'-3/16" (1586)	53'-6-1/4" (1632)	17'-7-1/4" (536)	16'-1-1/4" (491)	19'-8-1/4" (600)	18'-1" (551)
21	38'-1/2" (1160)	41'-2-1/2" (1257)	44'-6-1/2" (1358)				18'-5-1/2" (562)	16'-11-1/2" (517)	20'-7-3/4" (629)	19'-0-1/2" (580)
22	39'-10-1/2" (1216)	43'-2-1/2" (1318)	46'-8-1/2" (1424)				19'-3-3/4" (588)	17'-9-3/4" (543)	21'-7-1/4" (658)	20'-0" (610)
23	41'-8-1/2" (1272)	45'-2-1/2" (1379)	48'-10-1/2" (1490)				20'-2" (614)	18'-8" (569)	22'-6-3/4" (687)	20'-11-1/2" (639)
24	43'-6-1/2" (1328)	47'-2-1/2" (1440)	51'-1/2" (1556)				21'-0-1/4" (640)	19'-6-1/4" (595)	23'-6-1/4" (716)	21'-11" (668)
25	45'-4-1/2" (1384)	49'-2-1/2" (1501)	53'-2-1/2" (1622)	CONSULT FACTORY	CONSULT FACTORY	CONSULT FACTORY	21'-10-1/2" (666)	20'-4-1/2" (621)	24'-5-3/4" (746)	22'-10-1/2" (697)
26	47'-2-1/2" (1440)	51'-2-1/2" (1562)	55'-4-1/2" (1689)				22'-8-3/4" (692)	21'-2-3/4" (647)	25'-5-1/4" (775)	23'-10" (726)
27	49'-1/2" (1495)	53'-2-1/2" (1622)	57'-6-1/2" (1755)				23'-1" (718)	22'-1" (673)	26'-4-3/4" (804)	24'-9-1/2" (756)
28	50'-10-1/2" (1551)	55'-2-1/2" (1683)	59'-8-1/2" (1821)				24'-5-1/4" (744)	22'-11-1/4" (699)	27'-4-1/4" (833)	25'-9" (785)
29	52'-8-1/2" (1607)	57'-2-1/2" (1744)	61'-10-1/2" (1887)				25'-3-1/2" (770)	23'-9-1/2" (725)	28'-3-3/4" (863)	26'-8-1/2" (814)
30	54'-6-1/2" (1663)	59'-2-1/2" (1805)	64'-1/2" (1953)				26'-1-3/4" (796)	24'-7-3/4" (751)	29'-3-1/4" (892)	27'-8" (843)

* For Reverse-Fold or Mobile Operation, ADD 4 1/2" to Extended Dimension.

** For Closure Board / Last Deck Height, SUBTRACT 6 3/4" from Seatboard Height (Typical all seating surfaces).

Closed Dimension

No. Rows	Forward-Fold ^{2,3}			Reverse-Fold ^{1,3}			Mobile ³
	Manual 22 / 24	Friction 22 / 24	Non-Friction 22 / 24	Manual 22 / 24	Friction 22 / 24	Non-Friction 22 / 24	Manual 22 / 24
	3-10	3'-2-5/8" (98)	3'-2-5/8" (98)	3'-8-1/2" (113)	3'-8-1/4" (112)	5'-8-1/4" (173)	5'-8-1/4" (173)
11-12	3'-2-5/8" (98)	3'-2-5/8" (98)	3'-8-1/2" (113)	5'-8-1/4" (173)	5'-8-1/4" (173)	5'-8-1/4" (173)	3'-6-1/4" (107)
13	3'-2-5/8" (98)	3'-2-5/8" (98)	3'-8-1/2" (113)	5'-8-1/4" (173)	5'-8-1/4" (173)	5'-8-1/4" (173)	3'-6-1/4" (107)
14	3'-2-5/8" (98)	3'-2-5/8" (98)	5'-4-1/2" (163)	5'-8-1/4" (173)	5'-8-1/4" (173)	5'-8-1/4" (173)	3'-6-1/4" (107)
15	3'-2-5/8" (98)	3'-2-5/8" (98)	5'-4-1/2" (163)	Not Recommended	5'-8-1/4" (173)	5'-8-1/4" (173)	Not Recommended
16-20	Not Recommended	3'-2-5/8" (98)	5'-4-1/2" (163)	Not Recommended	7'-8-1/4" (234)	5'-8-1/4" (173)	Not Recommended

Closed Dimension – Wide Deck (Wall Attached Only)

No. Rows	Manual			Power*		
	30"	32"	33"	30"	32"	33"
3-10	4'-0-1/4" (123)	4'-2-1/2" (128)	4'-3-1/2" (131)	4'-0-1/4" (123)	4'-2-1/2" (128)	4'-3-1/2" (131)
11-20	Not Recommended	Not Recommended	Not Recommended	4'-0-1/4" (123)	4'-2-1/2" (128)	4'-3-1/2" (131)

*All dimensions for the power section of this chart are based on the Wide Track power system.



5981 East Cork
 Kalamazoo, MI 49048
 interkal.com
 Phone: 269.349.1521
 Fax: 269.349.6530
 Email: sales@interkal.com

©Interkal, Kalamazoo, MI Printed in U.S.A. Rev: 072018

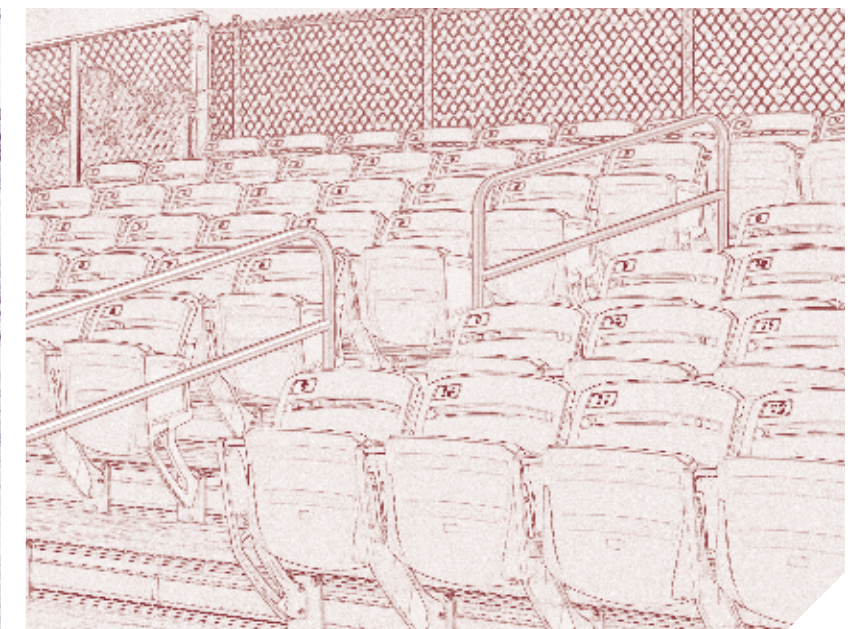
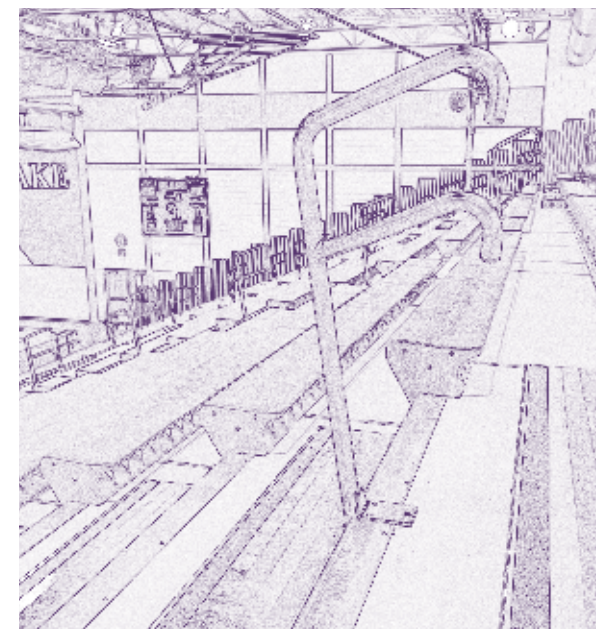
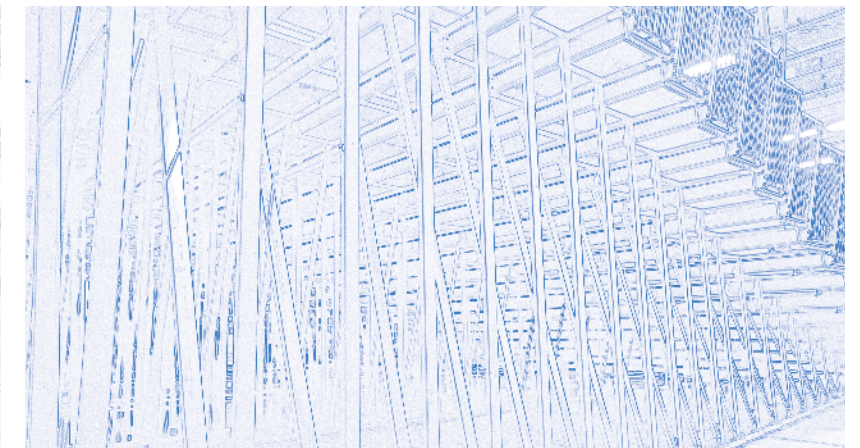
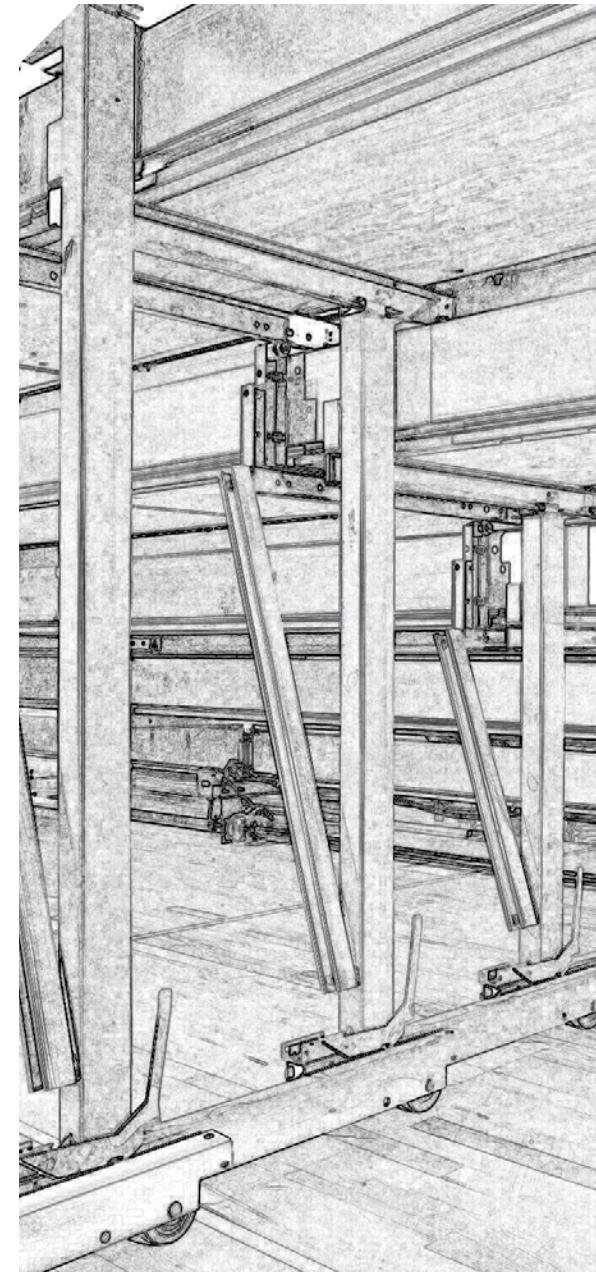



Interkal® ...always the best seat in the house

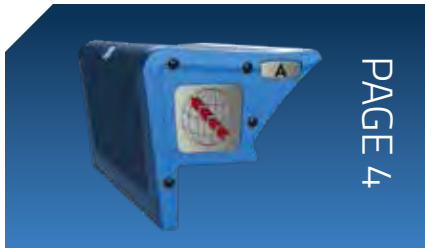

PAGE 4

ESM™ Excel Seat Module

- 10" seat depth
- 18" seat width
- Seat numbers, row letters, and personal logos



PAGE 6

SSM™ Sculpture Seat Module

- 12" seat depth
- 18" seat width
- Seat numbers and row letters



PAGE 8

CSM™ Contour Seat Module

- 10" or 12" seat depth
- 18" seat width
- Seat numbers and row letters



PAGE 10

ComfoBack® Automatic Contoured Backrest System

- Available in 28", 30", 32", or 33" row spacing
- Fully-automatic or manual folding operation
- Powder-coated cast aluminum uprights



PAGE 12

Classic Wood Bench Seating

- Dense southern yellow pine
- Grade BB or better
- Edge-glued and finger-jointed for strength and durability



PAGE 14

VISION™ Platform Chair

- Armrest cup holders (20" minimum seat width)
- Upholstered seat and back onserts
- Tablet arms



PAGE 16

POLARIS™ Multi-Purpose Seat

- 13.5" deep contoured seat
- Spacing to accommodate seat widths of 18" to 23"
- Unique color combinations available



PAGE 18

AURA™ Solid Stadium Chair

- Rear and armrest mounted cup holders
- Upholstered seat and back onserts
- End stanchion logos



PAGE 20

AURA™ Slat Stadium Chair

- Rear and armrest mounted cup holders
- Upholstered seat onserts
- End stanchion logos



PAGE 22

UNITED™ Platform Chair

- Plastic or timber armrests
- Back panel in plastic or timber
- Seat numbers and row letters

15 Standard Plastic Colors!

Choose from our wide range of standard colors for all Interkal seating types. All seating color options are complemented by light grey or black polydeck. Color depictions will vary slightly from actual color.

Please contact your local Interkal representative to verify your color selection.

Custom colors are available upon request.



Solid Injection Molding

Recessed seat numbers, row letters, and personal logos

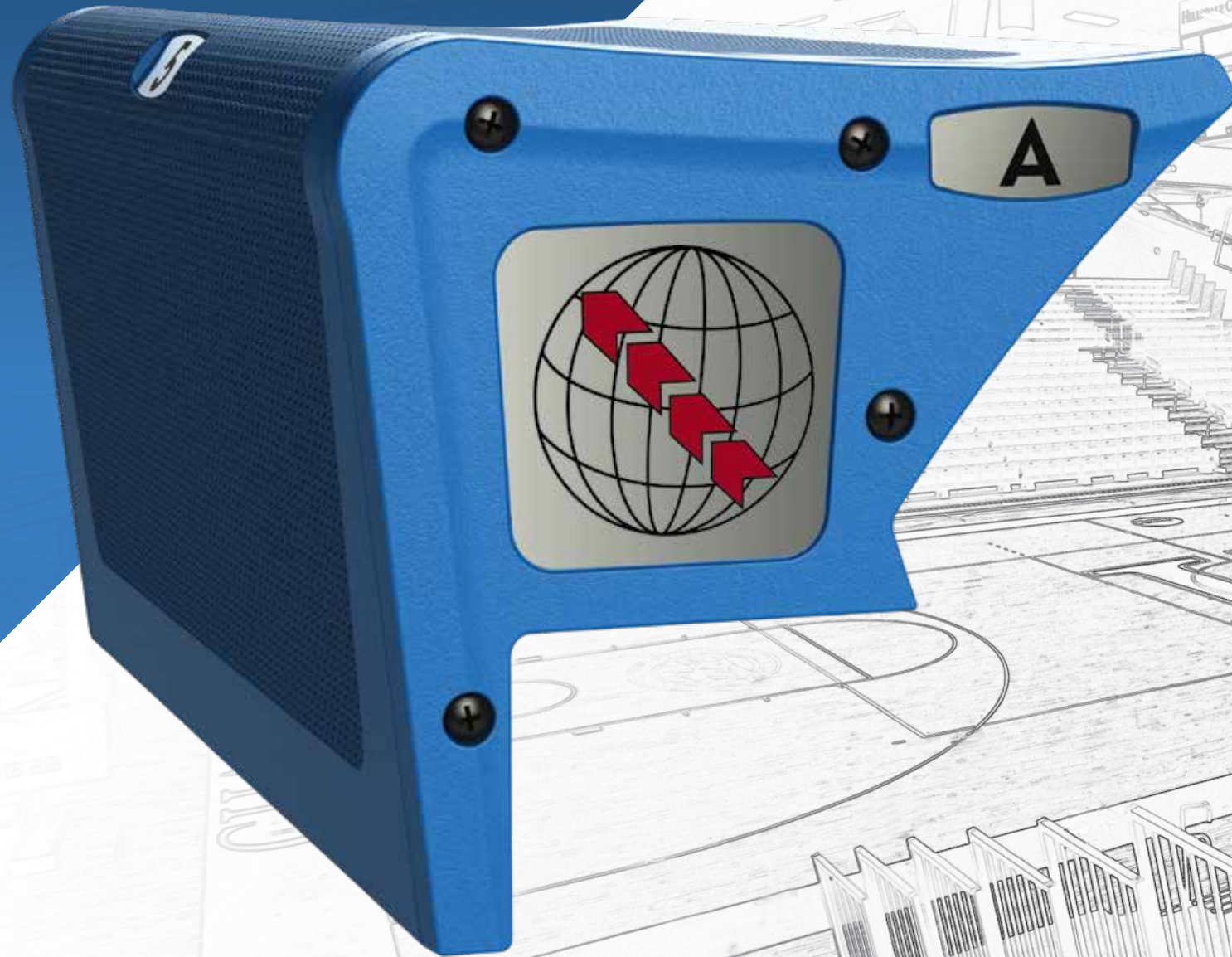

ESM 10" Excel Seat Module

Features

- Heavy steel bracket provides steel-to-steel through bolting at every 18" increment
- Structural ribs: Five vertical & three lateral
- Honeycomb design for unmatched vertical support
- Vandal-proof snap-lock feature with end caps

Durability

- Modules are constructed of one-piece injection molded high strength polyethylene which resists stains and will not splinter or warp. The molded-in solid color will not fade or wear out.
- For maximum rigidity, the specially designed attaching clamp provides a steel-to-steel connection of the module to the 14-gauge galvanized steel nosebeam.
- Each module incorporates a full perimeter interlock to secure one module to the next for increased strength.
- Five vertical and three lateral ribs inside each module provide superior support and are positioned for easy cleaning.

Easy Maintenance

- Easy to clean, easy to sweep—no obstructions at deck level
- No debris traps or exposed hardware

Comfort

- Plastic seat modules are anatomically contoured to achieve greater spectator comfort
- Each 18"-wide interlocking module provides a minimum adult seat height of 16½"
- Low profile ESM for high rise applications (shown bottom left)



12" Deep Seats

Consistent full-depth seat for increased patron comfort



SSM™ 12" Sculpture Seat Module

Features

- Heavy steel bracket provides steel-to-steel through bolting at every 18" increment
- Structural ribs: Five vertical & two lateral
- End caps

Solid Color Seat Modules

- These modules feature redesigned end caps and a full 360-degree interlock connection.
- Our wide range of 15 standard colors will complement any decor.
- Custom module colors, other than those shown, as well as contrasting end caps are available upon request. Color depictions will vary slightly from actual color. Please contact your local Interkal representative to verify your color selection.

Easy Maintenance

- Easy to clean, easy to sweep—no obstructions
- No debris traps or exposed hardware

Appearance

- A wide range of available colors dramatically increases aesthetic appeal and provides for interior design or school color options.
- Modular design concept clearly delineates each seat space and allows for ease of replacement should it ever become necessary. A recess in the module allows for optional seat numbering.
- Modules are available in 12" depths. The 12" Sculpture Seat Module requires a minimum of 24" back-to-back row spacing.

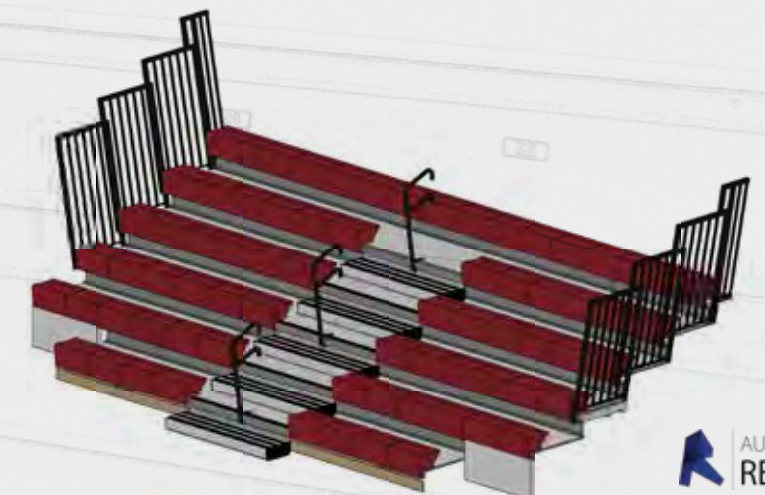

The Waterfall Face with a minimum 17" seat height offers unparalleled comfort

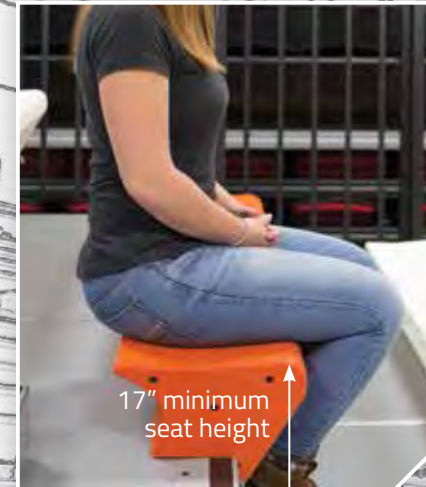
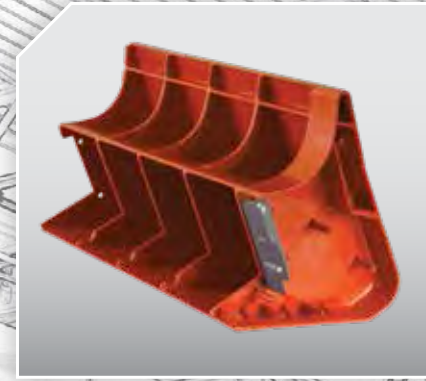

CSM™ Contour Seat Module

Features on the CSM™ include

- Heavy steel bracket provides steel-to-steel through bolting at every 18" increment
- Structural ribs: Five vertical & two lateral
- End caps
- Seat height—full 17" minimum
- Waterfall front allows for unparalleled comfort

Durability

- Modules are constructed of one-piece injection molded high strength polyethylene, which resists stains and will not splinter or warp. The molded-in solid color will not fade or wear out.
- For maximum rigidity, the specially designed attaching clamp provides a steel-to-steel connection of the module to the 14-gauge galvanized steel nosebeam.
- Each module incorporates a full ½" perimeter interlock to secure one module to the next for increased strength.
- Five vertical and two lateral ribs inside each module provide superior strength and are positioned for easy cleaning.

Comfort

- The "waterfall" front is highly functional as well as aesthetically pleasing. The additional seat height and angled face of the CSM allow patrons to pull their feet back underneath them, creating a smaller vertical envelope. This unique feature allows for the most comfortable experience, even in the tightest of quarters.
- Each 18"-wide Interlocking module provides a minimum adult seat height of 17" for greater comfort, even over extended periods.

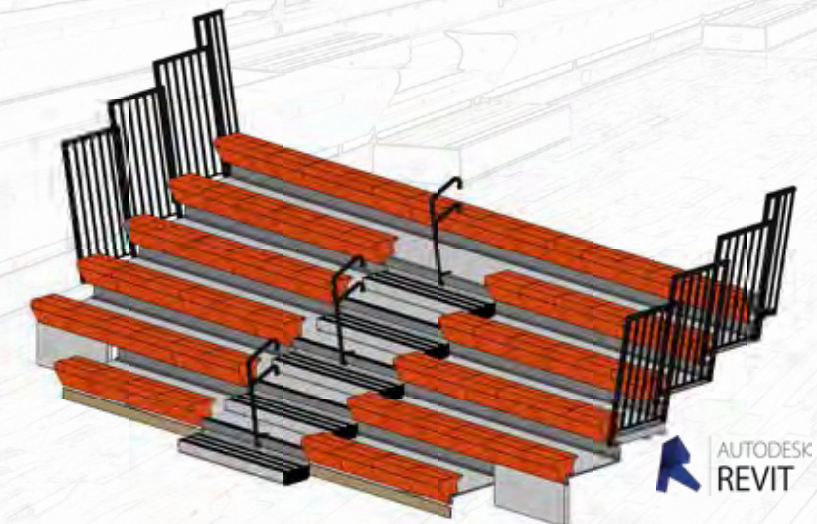

VIP Upgrade

Ergonomically designed backrests for maximum comfort at an affordable price



ComfoBack® with Polaris

ComfoBack® with ESM



ComfoBack® Automatic Contoured Backrest System

Features & optional accessories

- 18" wide ComfoBacks are available with fully-automatic or manual operation
- Available with 10" deep ESM in row spacing of 28", 30", 32", or 33"
- Available with 12" deep SSM in row spacing of 30", 32", or 33"
- Available with 13.5" deep Polaris in row spacing of 30", 32", and 33"
- A wide range of 15 standard colors
- A sleek appearance in the stacked position as well

1 Fully-Automatic Operation

Backrest raised and lowered with absolutely no labor required

2 Superior Comfort

Blow molded, ergonomically designed contoured back for superior comfort

3 Concealed Spring Mechanism

Concealed spring mechanism to eliminate pinching hazard

4 Black Powder-Coated

Cast aluminum uprights

5 Color Selection

Available in contrasting or matching module colors

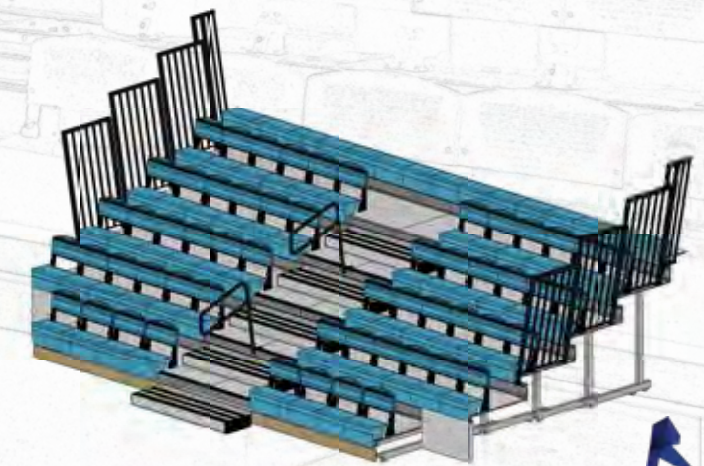

Southern Yellow Pine Lumber

Seat and riser boards are richly finished in classic style to greatly enhance the appearance of any gymnasium or fieldhouse



Custom 5/4" Nominal Seat Board available upon request

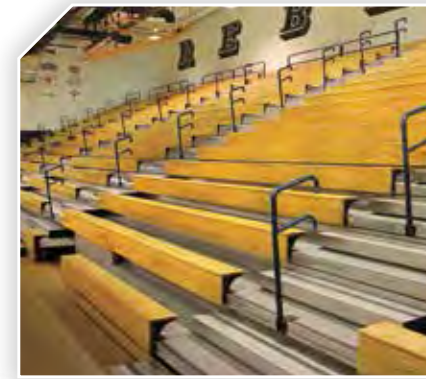

Standard 1" Nominal Seat Board

Classic Wood Bench Seating

Features

- Dense southern yellow pine, grade BB or better
- Laminated, edge-glued, and finger-jointed construction of wood boards for greater strength and durability
- Standard wood thickness: 1" nominal (3/4" actual)
- All boards finished on both sides and all edges
- Seats and front risers firmly secured every 36" to welded steel seat supports which attach to the continuous nosebeam for excellent stability
- Triple-sanded and sealed with moisture-resistant urethane
- A high-gloss urethane applied for added protection and to accentuate the richness and beauty of the wood
- Standard seat board depth 8 7/8" with 10" deep wood seat boards available upon request

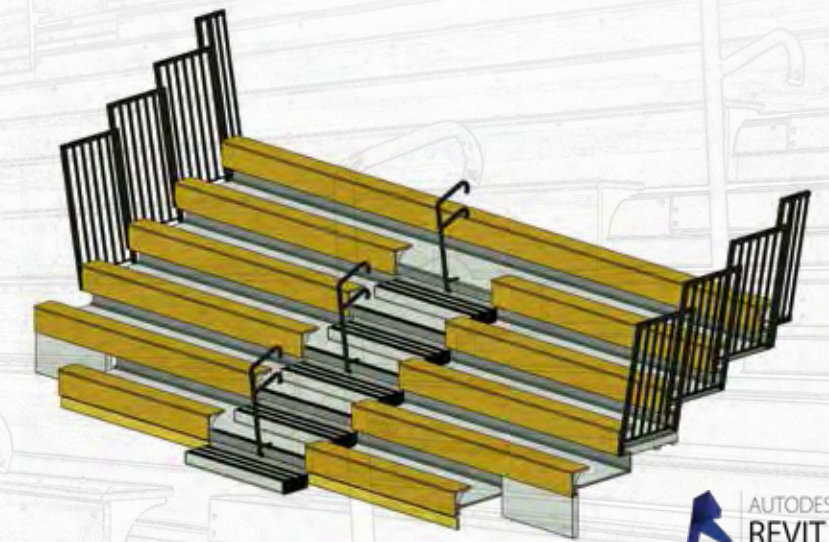



VISION™ Platform Chair

With its blow-molded plastic components and cast aluminum brackets, the VISION offers a unique combination of comfort and structural integrity.

Features & optional accessories

- Cup holders (20" minimum seat width)
- Upholstered seat and back onsets
- Tablet arms
- Seat numbers and row letters
- Available in 15 standard colors

The VISION maintains its seat pan width from front to back to make for a comfortable experience for patrons of all shapes and sizes.

Three types of fold-down operation to accommodate your individual needs

- Manual
- Semi-manual with assisted release
- Semi-automatic

Dimensions

- Available in 19.0" to 24.0" (483mm – 610mm) seat widths
- Minimum 10 ¼" (260.35mm) rise per row
- 18" (457mm) wide seats available in an armless option
- Available in 30", 32", and 33" (762mm, 813mm, and 838mm) row spacing



Tablet Arms



Outdoor Application



Cup Holders

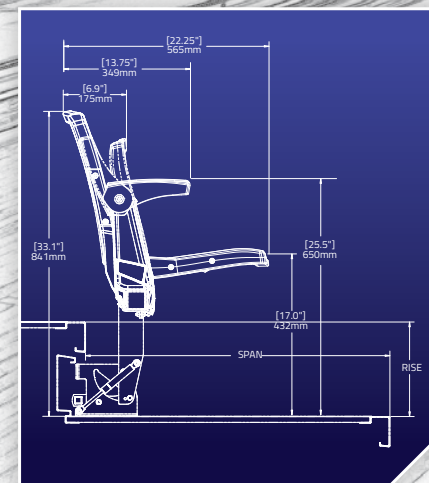

AUTODESK
REVIT

The **POLARIS** is a unique combination of bench and chair. Available in matching or contrasting colors, the contoured, blow molded components offer unsurpassed comfort in a 13.5" (343mm) bench seat depth.

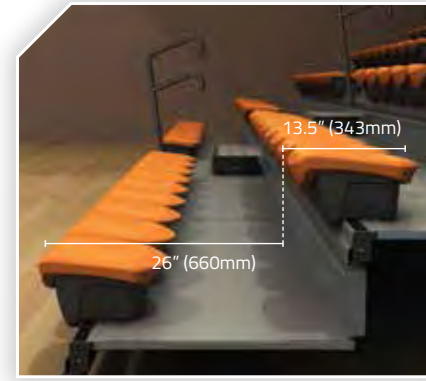

Polaris with armrest cup holders

POLARIS™ Multi-Purpose Seat

The POLARIS seat offers unique flexibility for telescopic seating.

Available in multiple options

- **Bench only** available in seat widths from 18" (457mm) to 23" (584mm)
Requires a minimum of 26" (660mm) row spacing
- **Bench with back** available in seat widths from 18" (457mm) to 23" (584mm)
Requires a minimum of 28" (711mm) row spacing
- **Bench with back and armrests** available in seat widths from 20" (508mm) to 23" (584mm)
Requires a minimum of 28" (711mm) row spacing
- **Bench with back and armrest cup holder** available in seat widths from 20" (508mm) to 23" (584mm)
Requires a minimum of 30" (762mm) row spacing

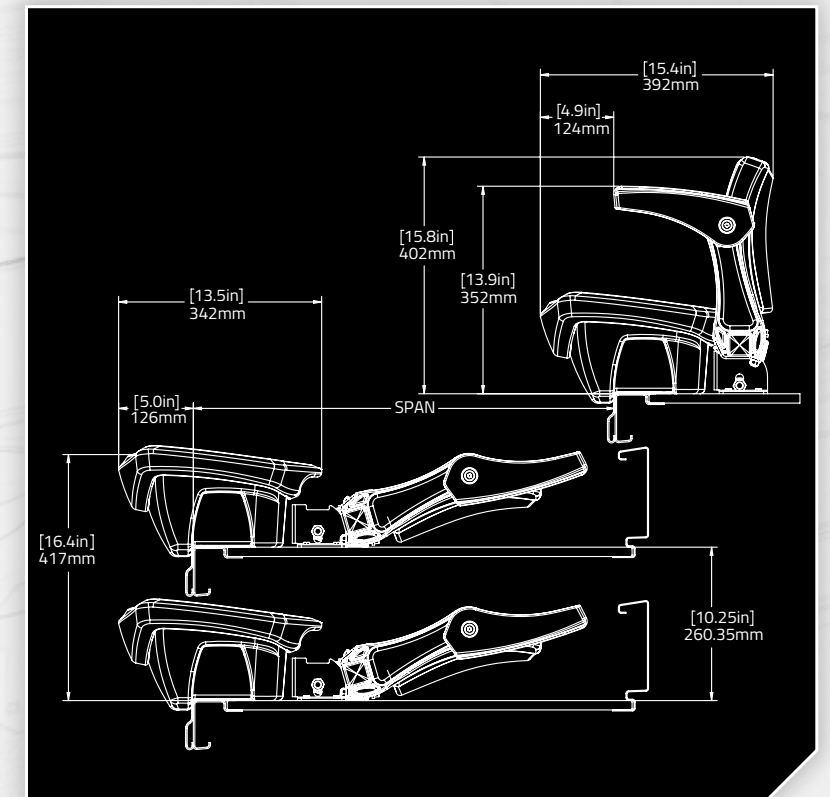

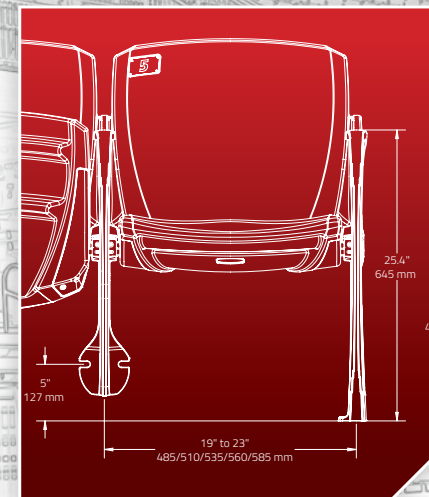

AURA™ Solid Stadium Chair

Unmatched comfort, style, and durability

Powder-coated cast aluminum stanchions will not rust, ensuring that your AURA stadium chairs will maintain their new look for many years to come.

Features & optional accessories

- Floor or riser mounted stanchions
- Cup holders
- Upholstered inserts
- ADA easy access stanchions
- Seat numbers and row letters
- 15 standard colors
- End-stanchion logos



ADA easy access stanchions

Utilizing the proven design of a stanchion-to-stanchion cross shaft through the seat pan, the AURA provides strength and durability that can be counted on over time.





AURA™ Slat Stadium Chair

Unmatched comfort, style, and durability

Powder-coated cast aluminum stanchions will not rust, ensuring that your AURA stadium chairs will maintain their new look for many years to come.

Features & optional accessories

- Floor or riser mounted stanchions
- Cup holders
- Upholstered seat inserts
- ADA easy access stanchions
- Seat numbers and row letters
- 15 standard colors
- End stanchion logos



ADA easy access stanchions



Utilizing the proven design of a stanchion-to-stanchion cross shaft through the seat pan, the AURA provides strength and durability that can be counted on over time.

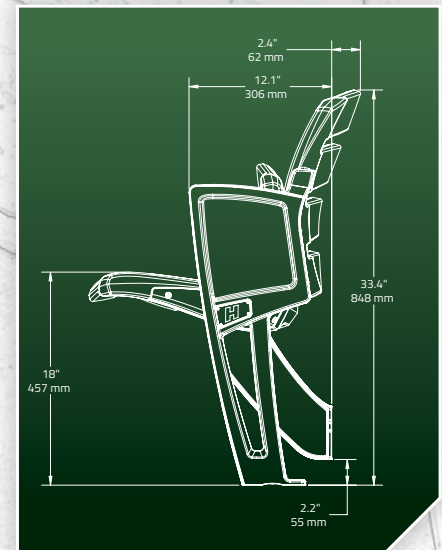

The United Chairs' unique flexibility allows for endless options in both fixed and telescopic applications



UNITED™ Platform Chair

Offering all the styling and comfort of an auditorium chair combined with complete flexibility, the United is suitable for both fixed seating and telescopic installations. The optional pocket sprung seat pan provides a luxurious feel to the chair and its unique rising action creates wide, safe walkways.

Features

- Self-rising design, with auto-rise armrest and the backrest acting as a counterweight
- Compact dimensions when closed
- High backrest for concert-level comfort
- Optional protective plastic panel to the back
- Pocket sprung seat core for outstanding support
- Elegant curved timber armrests

Accessories

- Timber outer back
- Protective plastic outer back
- Seat numbers
- Row letters
- Cup holder



BLACKOUT™



B4



B1

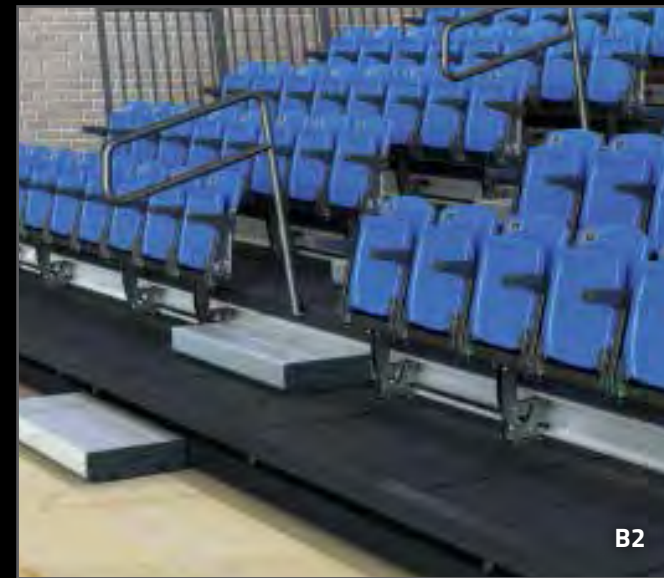

B2

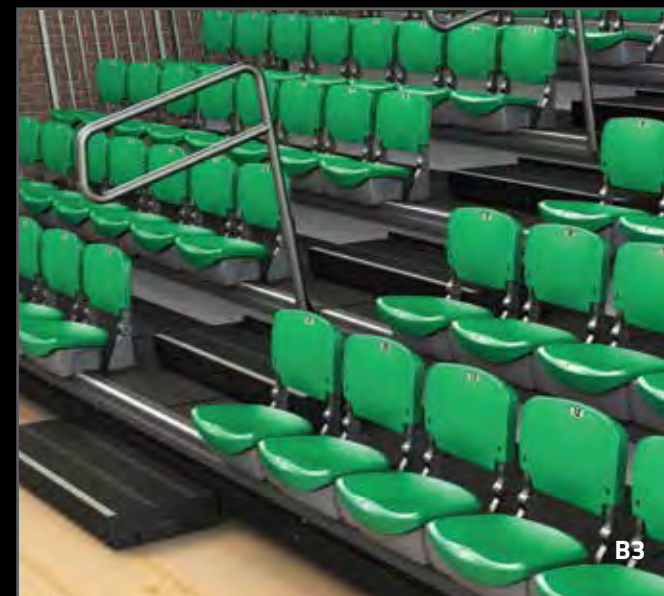

B3

BLACK Options

Give your facility distinction with extraordinary character!

B1

- Black polyethylene laminated deck boards, fascia panels, back panels, and end panels
- Black kick boards
- Extruded black PVC nose beam covers.

B2

- Black polyethylene laminated deck boards, fascia panels, back panels, and end panels
- Black aluminum trim encapsulating all polyethylene laminated boards
- Black kick boards
- Extruded black PVC nose beam covers.

B3

- Black polyethylene laminated deck boards, fascia panels, back panels, and end panels
- Black aluminum trim encapsulating all polyethylene laminated boards
- Black intermediate Steps at all aisle locations
- Black kick boards
- Extruded black PVC nose beam covers.

B4 - Blackout

- Black polyethylene laminated deck boards, fascia panels, back panels, and end panels
- Black aluminum trim encapsulating all polyethylene laminated boards
- Black intermediate Steps at all aisle locations
- Black rear riser beams at all rows
- Black kick boards
- Extruded black PVC nose beam covers.

The strongest understructure in the industry!

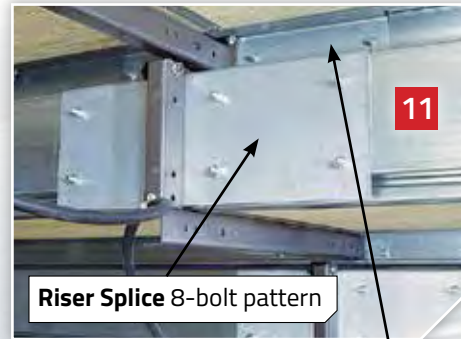

Riser Splice 8-bolt pattern

Nosebeam Splice 4-bolt pattern



Interkal supports the NFPA-102 mandate for annual bleacher inspection and maintenance. We strongly recommend a routine maintenance program.

The Interkal understructure is designed for maximum load-bearing capacity and eliminates deflection. It is constructed from the strongest and most durable materials in the industry for dependable performance you can count on for years to come. Because this understructure has few moving parts, trouble-free operation is assured with routine maintenance.

1 Sway Braces: All Interkal seating systems are stabilized by sway braces attached to the vertical columns and steel risers for maximum strength and resistance to movement. (Sway braces not required on rows 1 and 2.) Sway braces fabricated from steel are essential for vertical post bleachers to resist the compression and tension forces created when the bleachers are loaded.

2 Vertical Posts: Electric-welded continuous 2" x 3" closed seam, rectangular structural steel tubing produces the strongest and safest vertical columns. Post size increases depending on row height and load-bearing requirements.

3 Deck Supports: Deck support brackets are more rigid than competitive designs to help prevent sagging and potential binding during operation. All deck supports incorporate rollers for efficient operation and deck stability.

4 Nose Beam: All Interkal seating options incorporate a structural continuous galvanized nose beam, resulting in a uniform understructure. This component provides superior strength, continuous support for the plywood deck, and the flexibility to achieve any aisle location/configuration.

5 Superslide System: The low-friction flexible rod system guarantees positive engagement of vertical supports without binding, assuring smooth operation over uneven floor conditions. The superslide system maintains proper vertical column spacing, reduces wear, and helps eliminate racking damage.

6 Row Locks:

- Stabilize the bleacher under load in the extended position by securely locking each support post to an adjacent post.
- Automatically engage and release for opening and closing operation.
- Individual row locks make it possible to open any number of rows without opening the entire bank of bleachers.

7 H Beams: The aluminum "H" Beams located at every plywood joint provide continuous support from rear riser to nosebeam. It also facilitates ease of cleaning by eliminating unsightly gaps.

8 Wheel Channels:

- Wheel channels accommodate 8 to 12 wheels per channel for maximum weight distribution and operating ease.

- Wheel channels are precision formed from a single piece of steel coil for maximum rigidity.

- Heavy-duty composition rubber wheels are provided in a 3½" diameter by 1½" tread width.

- All wheels are provided with a ½" diameter steel axle secured with tamper-proof retaining rings.

- Wheels are equipped with oil-impregnated sintered metal bearings to assure smooth operation.

9 Deck Support Rollers: Nylon rollers at the top of every deck support minimize friction for smoother, quieter operation and enhanced deck stability. Our rollers eliminate steel-to-steel contact which would hinder the operation of the bleacher.

10 Riser Beam: Multi-bend component provides superior structural integrity.

11 Section Joints: 18" steel plates at every nose and riser to ensure the most rigid section joint available

Safety Features
Safety is the first and foremost concern in each and every Interkal design. The following key safety features are available:

- Limit switches on non-friction automatic power systems

- Plastic covers at every nosebeam exposed end and/or handicap location

- Removable pendant control attaches to the front of the seating system for added visual safety during operation of all automatic power systems

- Superslide System to insure positive engagement of all vertical posts

- Rear closure panels to prevent debris from collecting under units

- Aisles and rails in compliance with applicable code requirements



Applications: Telescopic Systems to fit a variety of facility configurations

Reverse-Fold Systems

(shown upper level, below) are designed for applications where space behind the bleacher stack is desired for other activities when the bleacher is not in use. This is common in areas such as mezzanines or balconies. Up to 18 rows can be specified with this system (over 18 rows, consult factory).



Forward-Fold Systems

(shown lower level, below) are the most typical application of telescopic seating in which the bleachers open in the forward direction. They are available up to 24 rows (over 24 rows, consult factory) and utilize either wall attachment or free-standing floor attachment.



Recessed Systems (below)

require minimal clearance to fit conveniently under a balcony overhang and maximize usable floor space when the bleachers are stacked. Available with any of the Interkal seating options up to 24 rows (over 24 rows, consult factory). Add one of our automatic power options for easy operation.



Mobile Systems (shown below left)

consisting of single sections of bleachers can be used in one part of a building and stored in another. They offer increased flexibility and are available with any seating option up to 14 rows at 10 1/4" rise and 12 rows at 11 1/2" rise. (over 14 rows, consult factory). Portable hydraulic dollies are provided for transport to various spectator or storage areas.



Custom Seating Arrangements Available:

- Pie-shaped sections for radiused configurations (shown far right)
- Truncated sections / notchouts to comply with the Americans with Disabilities Act (ADA) requirement for wheelchair seating
- Elevated front and rear walkways and cross aisles as required for code compliance, as well as improved sight lines
- Cut-outs for columns that extend out from rear wall

Please consult factory on these and other custom seating arrangements.

Free-Standing Floor-Attached Systems (shown above right)

are designed for applications where bleachers are required to be located away from walls or when wall construction prohibits attachment (shown here with back rails and back panels).

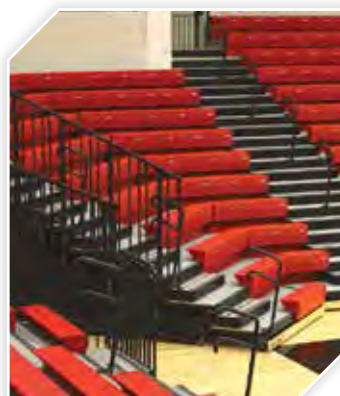

Self-Storing Aisle Rails

The Perfect Solution For Saving Set-Up Labor

- Aisle Rails are permanently bolted in position and automatically store in the deck, ensuring that the rails are in place at all times for spectator safety.
- This innovative design eliminates the need to individually set up each rail, maximizing labor savings.
- Revolutionary Patented Self-Storing Aisle Rails (SSAR)™ are exclusively from the leader in telescopic seating—Interkal!

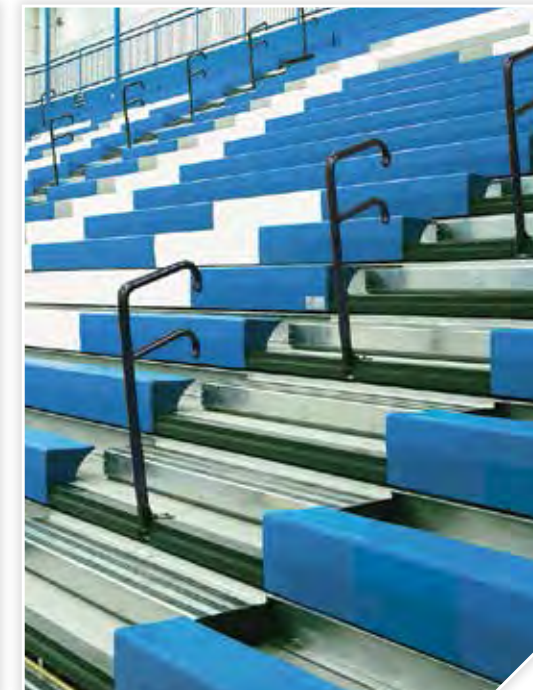

Provisions to Comply with ADA

We Engineer Flexibility Into Your ADA Compliance



36" wide, 1-row deep single notchout

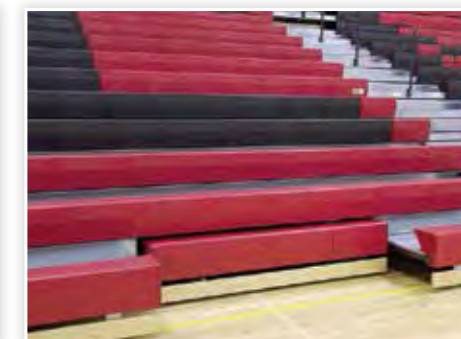

Double 1-row deep recoverable notchout shown in ADA mode



Recovered 1-row deep truncations



1-row deep double notchout with optional front rail

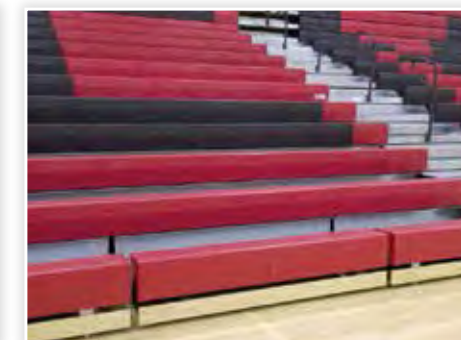

Double 1-row deep recoverable notchout shown in recovered mode



Double 1-row deep permanent notchout

Power Options

Nonfriction Power System (Right)

This is a fully-automatic power system designed to open and close wall-attached, recessed or reverse-fold telescopic bleachers at the touch of a button—without the need for traction force on the floor. Typically used for higher-row applications, it has the capacity to move more rows of bleachers than any other mechanical power system developed for the telescopic seating market. Limit switches are used to stop the 2HP, 208-230VAC, 3-phase motor in the fully open or closed positions. The chain drive pusher links assure years of dependable performance as well as nonslip, straight line operation.

Wide Track Power System (Below)

Our Wide Track Power System is U.L. listed and incorporates friction drive rollers as an integral part of the first row horse assembly. The two friction roller assemblies are linked by a continuous drive shaft driven by a ½ H.P. 208V, 3-phase motor. This continuous drive shaft controls drive roller operation in a straight, efficient manner—especially important on bleacher banks which include numerous notchouts or truncations.



Options & Accessories

1 Safety End Rails

are required on open ends of telescopic seating systems. Our self-storing end rails offer great convenience. These are designed and tested to meet all current building code requirements. Removable end rails are also available when required.

2 Vinyl Side Curtains

close off the ends of the bleacher with a heavy-duty laminated vinyl. Grommets at every hanger location, chainweight bottom hem. Available in 13 colors.

3 Aisle Center Rails

are installed on alternating rows and are available in both self-storing or quarter-turn types. Removable aisle rails are available when required.

4 Intermediate Steps

are designed to comply with applicable code requirements by providing an equal depth and height foot surface between rows. Safety abrasive tread is provided on all steps.

5 Video Platforms

are engineered to provide a stable platform for filming sporting events safely—integrated right into the seating system.

6 Removable Timer's Table

is an 18" by 96", high-pressure laminated work surface with removable legs which can be utilized at any location. The table leg assembly is constructed of tubular steel and the legs are easily removed for storage within the seating system.

7 End Panels

are designed to deter access behind units in the stored position.

8 Back Rails & Panels

are used on mobile, free-standing and reverse-fold units to provide added safety and close off access to the understructure.

9 Black Polydeck

offers a unique, sharp upgrade to our standard grey polydeck.

Additional Accessories

- Forward travel (aisle recovery for reverse fold units)
- Seat numbering on seat modules
- Vinyl ball deflectors
- Front rails
- Extended back panels
- Column cut-outs
- Balcony access steps

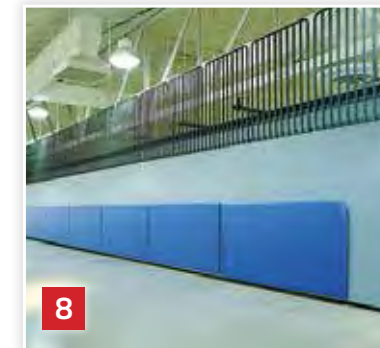
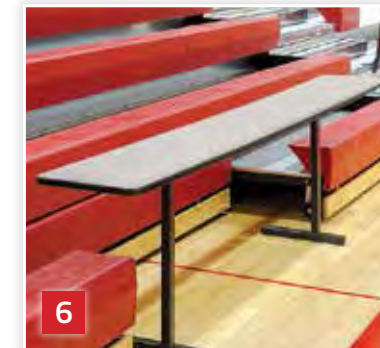
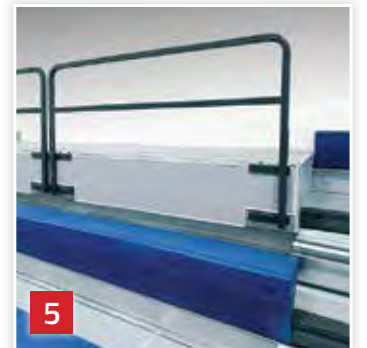
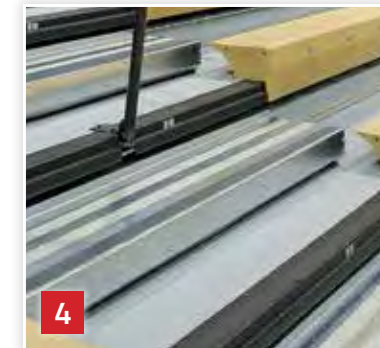
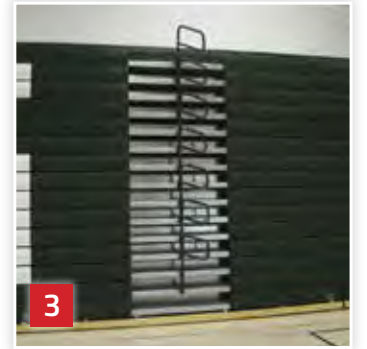
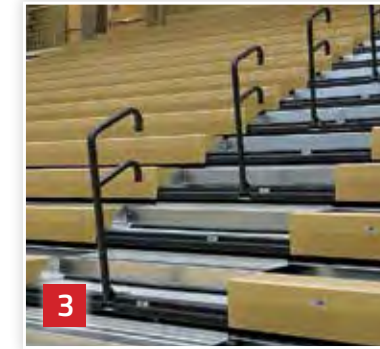
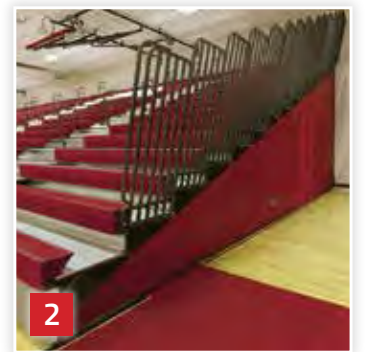
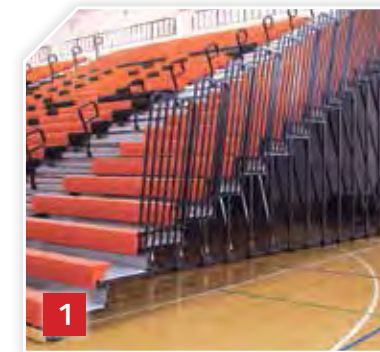

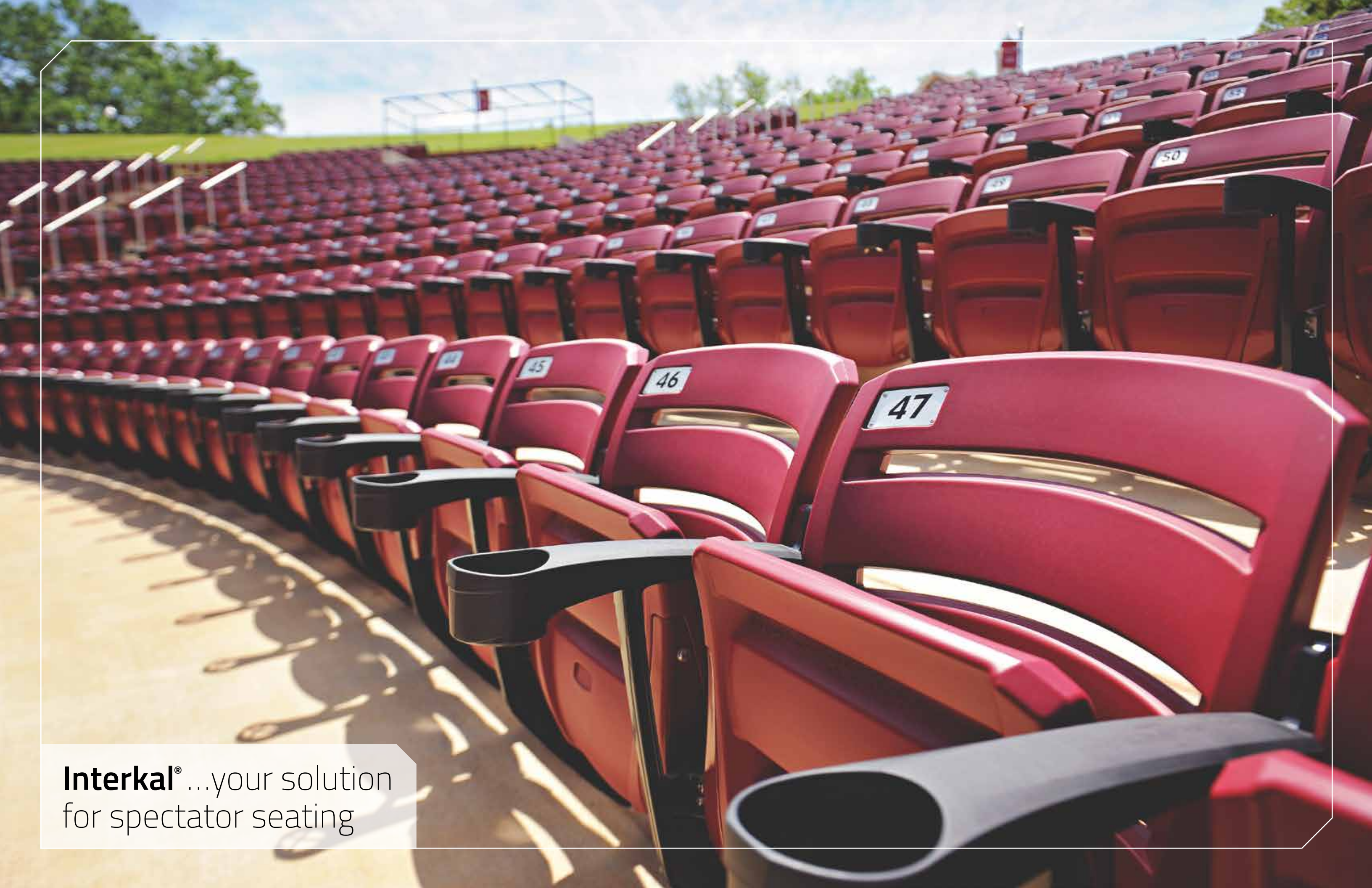

Interkal® ...your solution
for spectator seating