

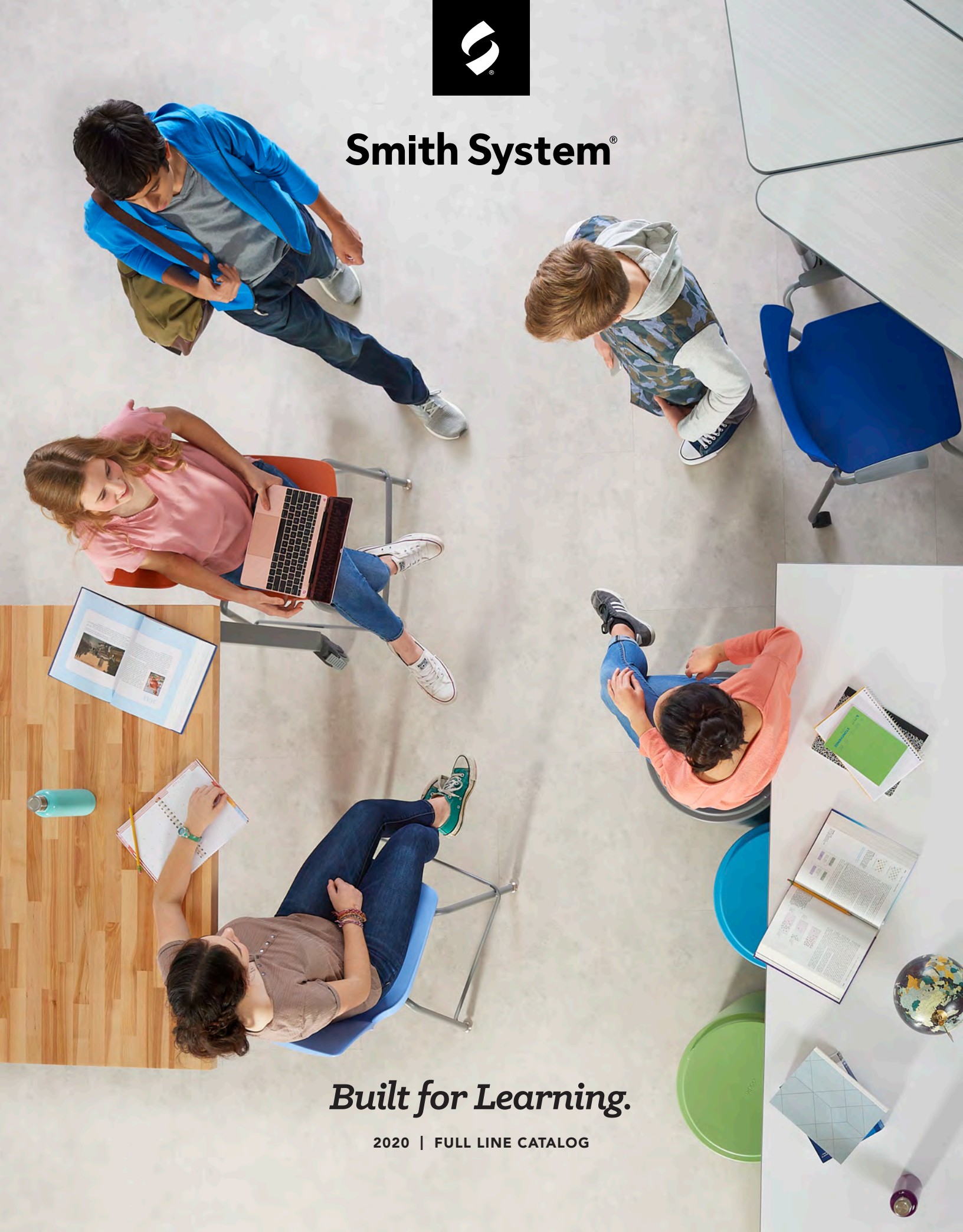

Smith System®



Built for Learning.

2020 | FULL LINE CATALOG



$$a^2 + b^2 = c^2$$





**Education is
always evolving.
So are we.**

Table of Contents

4

About Smith System

- 04 Welcome
- 06 Ages & Stages
- 08 Inspired Thinking
- 10 How to Purchase

12

Featured Products

- 14 Theorem® Chair
 - 16 Groove® Chair
 - 18 Soft Rocker
 - 20 Cascade® Maker Table
 - 22 Planner® Studio Table and Bench
 - 23 Planner Studio Whiteboard
 - 24 Elemental Next & Fold
 - 25 Oodle®
-

26

Inspiration Gallery

- 28 Pre-K Classroom
- 29 Elementary Classroom
- 30 Middle School Classroom
- 31 High School Classroom
- 32 Makerspaces
- 33 Open Spaces

34

Seating Intro

- 38 Groove
- 44 Theorem
- 52 Flavors®
- 60 Flavors Noodle
- 62 Plato®
- 68 In2it®
- 72 Oodle®
- 78 Soft Rocker

84

Desks & Tables Intro

- 88 Interchange®
- 116 Interchange Multimedia
- 122 Elemental
- 142 UXL®
- 154 Silhouette®
- 166 Flexline™
- 168 Planner®
- 204 Meeting



THE SMITH BLOG
www.smithsystem.com/smithfiles

222

Storage Intro

- 226 Cascade® Storage
- 230 Cases
- 234 Cabinets
- 238 Towers
- 242 Maker Table
- 244 Whiteboard
- 245 Spiral Noteboard
- 246 Tote/Shelf Units
- 247 Peg Board End Panels
- 248 Cubbies
- 250 Maker Cart
- 252 Teacher Wardrobe
- 253 Cascade Tote Trays
- 254 Teacher Desks
- 266 Library Carts
- 268 Booktrucks

273

Index

281

Terms & Conditions

Smith System®

The following, in word, stylized and design forms, are trademarks of Smith System Manufacturing Company: 3-2-1 Desk, Acrobat, Cascade, Chat, Elemental, Flavors, Flexline, Furniture for Inspired Learning, Groove, Huddle, In2it, Interchange, Interchange Diamond, Interchange Open Front Wing, Oodle, Planner, Plato, Sequence, Silhouette, Smith System, the Smith System "Swirl" Logo, Theorem and UXL (UXL Nest & Fold and Sit+Stand). Trespa and TopLab Plus are trademarks of Trespa International B.V.

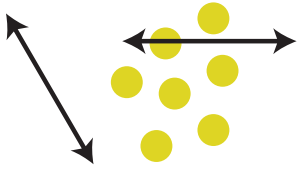

Welcome to Smith System

We design and build furniture exclusively for pK-12 learning environments. Every piece is optimized to account for how students work, learn, think and fidget across every age and stage. From the beginning, we work alongside you to create the best spaces imaginable for teaching and learning — school by school, classroom by classroom.

We don't make pK-12 furniture as part of what we do. It's the only thing we do.

Colors

- Mocha
- Mint
- Champagne
- Charcoal
- Purple
- Red
- Mocha
- Navy
- Yellow

Choice 1 1 1/4" top 3/8" Bumper T-Mold

Choice 2 1 1/4" top 4mm T-Mold

Choice 3 1 1/4" top 4mm T-Mold

Choice 4 3/4" top 4mm T-Mold

able in 3/4" and 1 1/4" thicknesses. When choosing (D, C, V) of top edge molding, put the designator at the end of the model number. Model 04500V = Model 04500 with a 3/4" top and a Bullet T-Mold edge. See the specific product page for available options.

251



Hand-drawn sketches of letters S, V, N, S, U, and E on graph paper. The letters are outlined with construction lines showing proportions and alignment.

MEDIA LAB

APPLE / NAVY

CERULEAN

ASIAN NIGHT

COMMONS

Room 201 B

Room 204 B

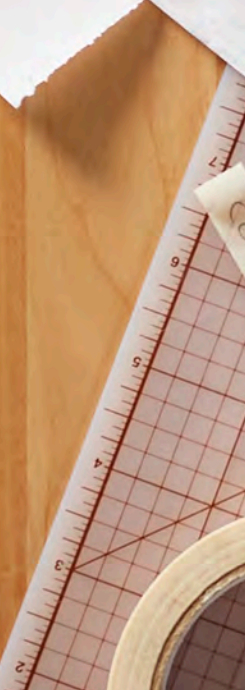

Designed for
every age, and
every stage.



Early adaption.

From the first day of pre-K, furniture must adapt to the needs of shifty little learners. We design early education environments that stand up to these demands to help children thrive.

Formative years.

Design doesn't happen in a vacuum. Every consideration is made to provide elementary students the support and flexibility they need for success.

Growth spurts.

Kids grow quickly but at different paces. Our furniture is designed to grow with the student, while accounting for variations in size and shape and meeting everyone's own unique needs.

Social status.

Middle school presents its own challenges, but durability and comfort should never be sacrificed. We create unique spaces that serve as the foundation for collaboration.

Head of the class.

By high school, it's imperative to break down the barriers to engagement. Our furniture is proven to empower the next generation of learners and leaders.



Thoughtful furniture for inspired thinking.

At Smith System, we build furniture that students, teachers, parents and school boards all can appreciate.

Quality + Value

School districts are hungry to provide the best learning environment for their students. But not every district has the budget to match the appetite.

We don't think they should have to.

This simple belief has transformed us into obsessive fine-tuners who spend our days improving the way we design, manufacture, assemble and deliver our products, so that our customers can get high-quality furniture at a price every district can afford.



Service

When it comes to investing in furniture for students that will last long after graduation, service must go beyond how you answer the phone. We're on a mission to lead our industry by example.

For every type of school environment, we promise durable, purposeful furniture designed for your students' needs. And we do whatever it takes to deliver it accurately and on time.

Partnership

In more than 100 years creating solutions for schools, we've learned a few things. Most importantly, we've learned that working together with dealers, designers and school administrations results in what's best for the school, teacher and student.

Smart people working together to solve a problem leads to better outcomes. It's what makes coming to work every day fun.



Before you begin:

Explore our space, first.

SmithSystem.com is your launch pad. We've carefully assembled an online library of information to help you hone your knowledge and stimulate your imagination. It's the natural result when we have really passionate people with over a century of experience to share.

Find insights and inspiration.

Guides: modern classrooms, commons and makerspaces

BIM Files: Revit, 2D/3D DWGs; we're also up on 20/20 and Project Matrix

Videos: graduate movement, STEM environments and Cascade storage

Blog: current education trends, best practices and customer case studies

Continuing Education: AIA course and presentation outlines

Social Media: photo updates and news on Pinterest, Instagram and Twitter

We love to chat.

You've got questions and guess what? We have answers. Our online chatters are standing by to quickly answer what's on your mind and steer you in the right direction.

Or better yet, give us a call, and together we'll explore what your school needs and pick from our full array of options for fun, functional furniture. Two minds are always better than one, right?

We do not sell direct to schools, but we do have a trusted network of authorized local, regional, national and online dealers. Your dealer will help in making final choices, placing orders and installing your shiny new furniture.

Call us at 800.328.1061 or use our online chat system for immediate answers.



What we offer educators.



Innovative Design

Beautiful furniture designed to create comfortable, healthy and engaging learning environments.



Exceptional Customer Care

An attentive sales force, 24/7 support, and the best customer service in the industry.



Durable

Seating, desks, tables and storage units that stand up to decades of wear and tear from students (and their backpacks).



On-Time Shipping

Orders made fresh to your specs and shipped without delay — even during peak season.



Customization

An impressive palette of color options for laminate tops, edges, paint and chair shells. Boost school spirit, stay subdued, or go bold.



Modern Thinking

Product lines that connect students to modern curricula and current research on how kids learn best.



Value

A wise investment in quality furniture that has become the brand of choice for many of the largest school districts in the states and abroad.



Environmental Health

Our entire product portfolio is 100 percent certified to meet indoor air quality standards for children and schools through UL GREENGUARD.



Great Warranty

A limited 12-year warranty, with a lifetime frame warranty. Find out more at smithsystem.com/about-us/warranty.

That's what our customers love most.

Featured Products.

What's your new favorite?

We're excited to share the next generation of Smith System products that will transform your classrooms and learning spaces.



Theorem® Chair

As kids grow up, so do their seating needs. Smith System's answer to this challenge is the all-new Theorem Chair. In Theorem, we're offering young adult learners a task-based chair that's nothing short of comfort and sophistication.

See page 44



Behind the Design

“We were charged with taking Smith’s successful Flavors chair concept further, into the pre-collegiate level. That meant designing a chair that was so comfortable, yet purposeful, that you could stay on task for a full eight-hour day.

A nylon shell is unique in the K-12 market. It costs a bit more, but it’s worth it. Foremost, nylon is very strong, so even though Theorem’s one-piece shell is only 4 millimeters thick, it doesn’t need back ribbing or heavy hardware to be durable. That minimal depth also keeps the shell flexible and gives the chair a sleek profile and rearview, with clean, thin edges. This makes Theorem unlike anything currently on the K-12 market.”

– Roger Carr
Radar GB, London

New Theorem Arm Chair (left) and new Theorem Wire Rod Frame Chair and Stool (right).



Featured Products



New 14" and 16" Groove Chairs.

Groove® Chair

Its name may sound old school, but Smith's new Groove chair line brings modern, high-tech design to current educational environments. The result is K-12 seating that delivers impressive ergonomic and aesthetic benefits.

See page 38



Behind the Design

"It's about getting into the groove of learning faster. Groove is immediately supportive and comfortable for students. They can feel great and get to work, with less settle time. Subconsciously, we all try to find that sweet spot when we first sit down. When a chair is comfortable, we don't really think about it. But if it's uncomfortable, we squirm and shift and move continuously. It's distracting.

Groove has a larger surface with a gentle contour and slightly higher upper-back shell to spread the student's weight over a larger surface area. But we use a slim "waist" design with good lumbar support, so kids can turnaround easily and maintain good posture."

—Dorsey Cox
Dorsey Cox Design



Soft Rocker and Ottoman

The Soft Rocker and Ottoman are ideal for individual study and casual group-work areas – reading nooks, your commons, libraries and media centers, or any collaboration hot spot. The generous seat back and seat pan easily accommodates older teens and adult staff. But by keeping the overall chair height to just under 26 inches, little learners can quickly settle in, too.

See page 78





Behind the Design

Great ergonomics make this chair the ultimate form of comfort. The high-density foam core provides the right amount of relaxing give, while a compact, hardwood frame ensures a sturdy sit. The slight pitch in the back support and subtle curve in the base encourage safe, smooth rocking. It's irresistible, even for adults.

Accidents happen. The 100% EPU Polyurethane (vinyl) fabric is easy to clean with a 4:1 water-bleach solution. Simply mist, wipe, and relax.

We set out to demonstrate that upholstered K-12 seating can match the standard of durability we've set for all of our furniture. We used corner blocking at load bearing connections, a webbed back frame, and hearty vinyl that can stand up to any test.



Cascade® Maker Table

New for this year, the Cascade Maker Table provides an all-in-one workspace to create, store and create some more. The broad surface and optional lockable storage help you re-imagine the ease and efficiency of your Maker space in a simple, mobile and multi-functional unit.

See page 242

Planner® Studio Table and Bench

The Planner Studio Table and Bench combo is setting a new standard for modern collaboration. With single or double seating options, the Planner Bench is as versatile as it is colorful, quickly adapting to any learning environment.

See page 172



Planner® Studio 30" Table

The Planner Studio Table is setting a new standard for modern collaboration. With single or double seating options, the Planner Bench is as versatile as it is colorful, quickly adapting to any learning environment.

See page 172





Behind the Design

“We were asked to design a companion piece to the Planner Studio line. The whiteboard matches the style and function of the Planner Studio series to create a bright and cohesive space.

Students need ease and movement to create, and we want to continue building that experience, to enable collaboration and the effortless flow of ideas. We tried to pack in as many features, from the marker and presentation ledges down to the lockable casters for quick start-stop mobility.”

– *David Williams, Designer*

Planner Studio Whiteboard

The Planner Studio Whiteboard perfectly complements our Planner Studio line of tables to create a unique and creative environment for today’s learners. It provides a sophisticated-looking two-sided mobile writing surface and includes a small shelf located on both sides to hold markers and erasers.

See page 183

Elemental® Nest & Fold

Elemental Nest & Fold Tables provide a stable, spacious work surface and contemporary appearance. They offer added utility when not in use through their easy mobility and compact storage. Because they're part of an integrated line of tables and desking, they allow a consistent design scheme throughout the building or facility.

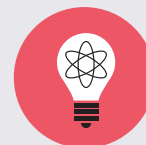

See page 138



Shown with new Theorem® Wire Rod Frame Chairs. See page 47.

Oodle®

Instead of a chair, pull up an Oodle. Ideal for collaborative learning and common areas, Oodle is easy to gather into a circle, arrange around a table or stack up at a counter.

See page 72

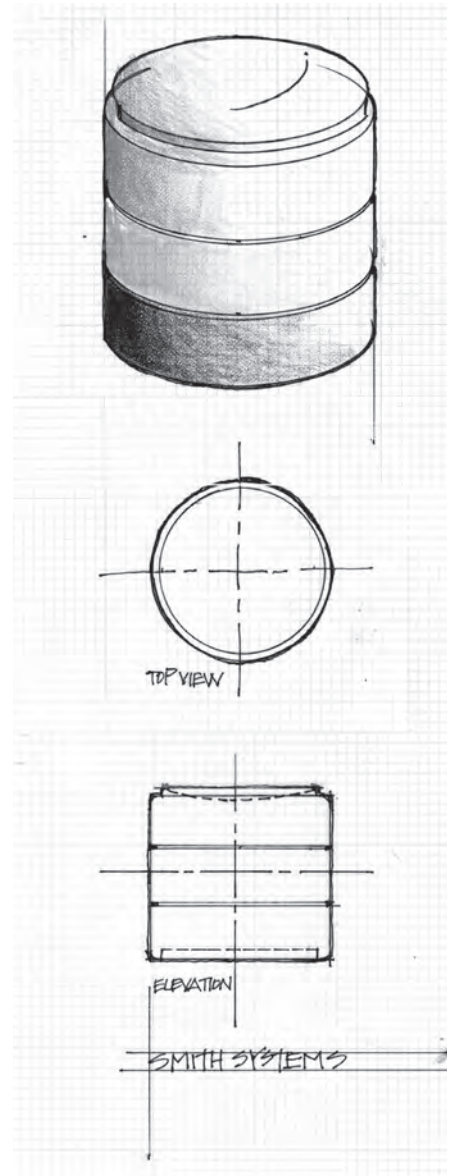

Behind the Design

Award-winning designers Joe Ricchio and Charlie Patterson of Ricchio Design, developed the Oodle stool. They envisioned a bold, graphic form — simple cylinder — to bring to life Smith System’s idea for movement-optional seating.

The result is something completely new. Joe says, “Oodle is more fun, straightforward and casual than other movement-friendly classroom furniture. The simplicity and multi-function capability are real benefits.”

The broad dimension, mix and match stackability and innovative rocker base add up to a fun and functional space maker.

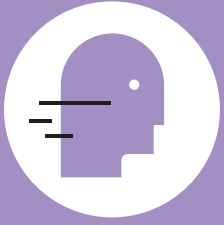

Moving at the speed of learning.

Our singular focus on pK-12 furniture allows us to stay on top of emerging trends for new and unique spaces. From classrooms to makerspaces, every room has its purpose and its opportunity for innovation. That's why we move quickly to create solutions that fill real needs, based on the demands of modern learning environments.

Collaborative Learning

Whether it's peer-to-peer or larger groups, team collaboration is now the norm. Learning is a social act, and a student-centered classroom gives kids more time to think about, talk about and process information together.

Flexible Seating

Also known as “alternative seating,” a flexible-seating classroom lets students diplomatically decide where and how to park their bodies. It means providing options to sit, stand, kneel, wiggle or rock — and adjust furniture to their size.

Makerspaces

Some call it this. Some call it STEM or STEAM. Either way, it's an incubator for problem solving, creativity and collaboration. It must remain a highly versatile hotbed of engaging zoned spaces, materials and tools.

Customized/ Personalized Learning

Technology has made custom teaching to the needs of each individual student possible. It means giving them choices, which is empowering. And empowered students learn more and they learn better.

Active Seating

Sitting perfectly still is uncomfortable, if not impossible, even for adults. Active-seating chairs encourage natural movement by offering varying degrees of torque. These chairs move with, rather than against, active students, especially the fidgeters.

Re-Imagined Spaces

New challenges require new environments. Libraries are now media centers; science rooms are tech labs and computer labs; cafeterias are catchall commons. These spaces have unique furniture needs, among them versatility, durability and comfort.





Pre-K Classroom

Busy minds drive busy bodies. Create a welcoming, organized environment tailored to whirlwind tots and their teachers. Child's play? Hardly. Whether you call it Pre-K, preschool or early ed, ages 3 to 5 are prime time for development. Students will begin to learn essential academics, social skills and self-control, mostly through play. Set the stage for these little sponges.



Elemental® Moon Table

See page 128



Elementary Classroom

Teaching styles and classroom layouts vary wildly in elementary school. At the K-4 or K-5 age, teachers want learning and communication on track, but lighter. Students are still learning through play. They need engaging, hands-on opportunities for meaningful learning. They want to experiment and be experiential in a comfortable, predictable environment.



Oodle®

See page 72





Middle School Classroom

Classroom furniture should help kids discover their interests and hone critical thinking, within a structured environment. Students in grade 5/6 to 8 are in the middle. Physical, social and emotional growth is truly in flux. Academically, they are exploring new ways of thinking, with more intensive subject work — and socializing. Teachers need tools that focus student attention without (gasp) drawing attention.



Multimedia Tables

See page 116



High School Classroom

High school is time to prepare for higher education and the future workplace. The high school classroom should provide real-life settings where students focus on real-world problems. During high school, a student's future slowly starts coming into focus. Educators need to teach what employers want in the next generation: critical thinking, team collaboration, creativity and problem solving.



Interchange® Crescent Table

See page 108





Makerspaces

Tinker, create, explore, fail. Makerspaces promote them all by providing a range of tools, from high-tech to no-tech, that encourage experimentation. The ideal makerspace furniture helps manage materials and projects, without getting in the way.



Planner® Studio Tables

See page 172

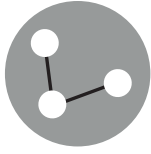

Open Spaces

Students are more tech-savvy than ever. Technology is practically in their DNA. Likewise, tech labs and computer labs must be ready to accommodate everything from beginning coding to high-level robotic competitions. We make the lab furniture to handle that spectrum.



Planner® Studio Whiteboard

See page 183



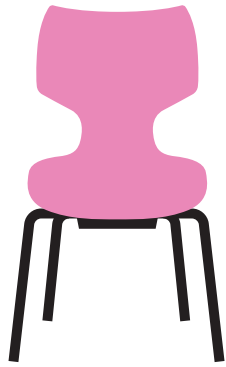

Seating

Seating is unique as a fingerprint. Students sit in thousands of different positions; upright, slouched, twisted and tilted. They stretch out their legs, sit on them, cross them and bounce them. They will balance on their chair or teeter on the back, tempting gravity — and common sense.

Built for Learning.

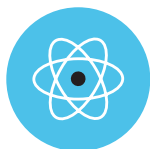



Seating

Learning has evolved. Seating has adapted.

Like all of our furniture, our seating concepts were developed for pK-12 students. From their very specific size ranges to their innovative contours — these chairs and stools are ready for learning in any environment or situation.



Groove®

Immediately supportive and comfortable. Students can feel great and get to work, with less settle time. The ergonomic seatpan and subtle shell contours support movement in a working posture at a desk and sideways sitting. *See page 38*



Theorem®

Offers two major seating positions — vertical and slight recline — to perfectly support high school learning. The chair's seat is contoured 5.5 degrees, which is deeper than most stacking chairs. *See page 44*



Plato®

Allows more movement, so students can face front and both sides. This Euro-spec chair provides a wide seatpan, flex and pronounced lumbar support to encourage good posture and breathing. *See page 62*



In2it®

Conceived to contain movement and direct attention straight ahead. It works like a bucket seat, providing back and shoulder support, while orienting the student toward the front. *See page 68*



Oodle®

A revolutionary new active seating line that puts the fun in classroom functionality. Featuring a unique movement disc base that allows for 10 degrees of movement. *See page 72*



Flavors®

Offers maximum movement and four seating positions. Its seatback flexes front to back and torsionally, allowing students to shift and move without chair resistance. *See page 52*



Soft Rocker

Smith System offers a new style of movement based active seating in our Soft Rocker. Children, adolescents and even adults love the rocking motion and natural engagement it provides. *See page 78*

Which ergonomics matter most?

Here are some ways administrators can get the most ergonomic bang for their buck.

Right Fit/Adjustable.

- Both seating and desks need to be properly scaled to fit the size of the individual student.
- We offer a wide range of heights in seating — typically four or five per product line. Our desking lines are adjustable in height as well.

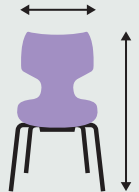

Right Size.

- Properly sized classroom seating supports healthy posture and decreases fidgeting.
- Students should be able to sit with their feet firmly planted on the floor and their backs against their chairs.

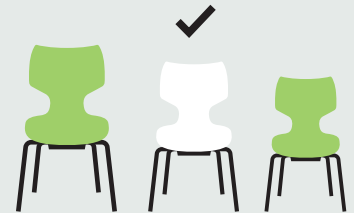

Function.

- 21st century learning often requires seating to be moved throughout the day, so chairs must be light enough, or fitted with casters, to allow students of all ages to move them quickly and easily.

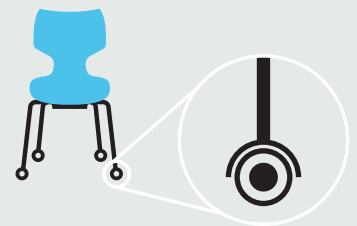

Seating That Doesn't Fight The Student.

- A chair that allows some movement on the part of the student can promote learning. But how much movement?
- Consider our Graduated Movement Concept, a design idea educators can use to tailor the ergonomics of the classroom furniture to support the curriculum. Through subtle differences in design, our In2it line gently limits movement, Plato allows moderate movement and Flavors permits utmost movement.



Seating Groove®

Get into the Groove.





Stack Chair



Mobile Stack Chair



Fixed Height Stool



Cantilever Base Chair



Adjustable Chair



Adjustable Stool

Flex you can feel.

Groove is designed with a “flex” seat surface. The gentle contour and slightly higher upper-back shell spread the student’s weight over a larger surface area. The slim waist design and strong lumbar support, so kids can turnaround easily and maintain good posture.

Streamlined aesthetic.

High-tech injection molding not only keeps the seatback strong and flexible, but it eliminates the exposed structural “ribs” on the back of the chair’s shell. We also used a smaller tube diameter for the frame. Groove doesn’t look like an institutional classroom chair. It’s sleek and calm, yet familiar. It’s a crossover chair that quietly blends in anywhere: classrooms, cafeterias, flex studios, maker spaces and more.

Three-position ergonomics.

Kids are creative sitters! The ergonomic seatpan and subtle shell contours support movement in a working posture at a desk and sideways sitting. A gentle flex at the top of the shell opens the contours up for a reclining position. Groove also features a generous waterfall seat front to support circulation to students’ legs and feet.

Modern manufacturing.

New for Groove, we used a more modern injection molding technique for the polypropylene shell. This means the plastic is left thicker for more strength in high-stress spots, and thinner for less-stress areas. The result means more flex and less chair weight without sacrificing strength.

Seating Groove®



Model 33849

18" seat height, 'A' Shell.
Shown in Persian Blue with
Platinum frame.

Model 33849

18" seat height, 'A' Shell.
Shown in Orange
with Platinum frame.

Model 33848

16" seat height, 'B' Shell.
Shown in Mint
with Platinum frame.

Model 33847

14" seat height, 'B' Shell.
Shown in Cerulean
with Platinum frame.

Groove Stack Chair

Immediately supportive and comfortable. Students can feel great and get to work, with less settle time. The ergonomic seat pan and subtle shell contours support movement in a working posture at a desk and sideways sitting. A gentle flex at the top of the shell opens the contours up for a reclining position. Generous waterfall seat front to support circulation to students' legs and feet.

- The shell rests on the frame, not rivets, to add comfort.
- High-density polypropylene with color throughout the shell.
- Durable swivel base glides with non-staining nylon bases and chrome-plated steel covers come standard.
- Choose optional steel or felt glides.
- The legs are strong, 14-gauge welded steel.
- Choose legs with durable chrome finish or platinum powder coat finish.
- Stacks four chairs high.

Model	Description		D"	W"	H"	F.C.	Cube	Wt.	UPS	List Price
33847	Groove Stack Chair	B shell – 14"h	18.5	17.5	14	125	2.7	9	*	\$ 95.00
33848	Groove Stack Chair	B shell – 16"h	18.5	17.5	16	125	2.7	9	*	\$ 99.00
33849	Groove Stack Chair	A shell – 18"h	20.5	19.5	18	125	2.7	10	*	\$ 109.00
S	Steel glide optional	Set of 4 installed								upcharge
F	Felt glide optional	Set of 4 installed								upcharge

Glide Options:

Nylon base glides are standard. Steel and Felt base glides are optional and are quoted.

This is factory installed option not available for field installation. Glide option must be on original chair order.

Steel glide option: Add 'S' to follow Model No.

Felt glide option: Add 'F' to follow Model No.

Chrome frame option: CHR

Platinum frame option: PLT



Model 33855
18" seat height, 'A' Shell.
Shown in Charcoal with
Platinum frame.

Groove Mobile Stack Chair

Immediately supportive and comfortable. Students can feel great and get to work, with less settle time. The ergonomic seat pan and subtle shell contours support movement in a working posture at a desk and sideways sitting. A gentle flex at the top of the shell opens the contours up for a reclining position. Generous waterfall seat front to support circulation to students' legs and feet.

- The shell rests on the frame, not rivets, to add comfort.
- High-density polypropylene with color throughout the shell.
- The legs are strong, 14-gauge welded steel.
- Choose legs with durable chrome finish or platinum powder coat finish.
- Stacks four chairs high.

Model	Description		D"	W"	H"	F.C.	Cube	Wt.	UPS	List Price
33854	Groove Mobile Stack Chair	B shell – 16"h	19.5	18.5	16	125	2.4	9	*	\$ 129.00
33855	Groove Mobile Stack Chair	A shell – 18"h	22	20	18	125	2.4	12	*	\$ 139.00



Model 33879
Shown in Cerulean
with Platinum frame.

Groove Cantilever Chair

Immediately supportive and comfortable. Students can feel great and get to work, with less settle time. The ergonomic seat pan and subtle shell contours support movement in a working posture at a desk and sideways sitting. A gentle flex at the top of the shell opens the contours up for a reclining position. Generous waterfall seat front to support circulation to students' legs and feet.

- The shell rests on the frame, not rivets, to add comfort.
- High-density polypropylene with color throughout the shell.
- Choose optional felt glides.
- The legs are strong, 12-gauge welded steel.

Model	Description		D"	W"	H"	F.C.	Cube	Wt.	UPS	List Price
33879	Groove Cantilever Chair	A shell – 18"h	18.5	19	18	125	2.0	12	*	\$ 169.00
<i>F</i>	Felt glide optional	Set of 4 installed								\$ upcharge

Glide Options:
Nylon base glides are standard.
Felt base glides are optional and are quoted.

This is factory installed option not available for field installation.
Glide option must be on original chair order.

Felt glide option: Add '*F*' to follow Model No.
Chrome frame option: *CHR*
Platinum frame option: *PLT*

Groove Chair Shell Color Choice

● Apple	● Burgundy	● Chocolate	● Fuchsia	● Navy	● Purple	● Chrome
● Black	● Cerulean	● Clementine	● Mint	● Orange	● Red	● Platinum
● Blueberry	● Charcoal	● Forest Green	● Persian Blue	● Yellow		

View all finish options on page 271

Seating Groove®



Model 33889

Shown in Charcoal with Platinum frame.

Model 33891

Shown in Yellow with Platinum frame.

Groove Fixed Height Stools

Immediately supportive and comfortable. Students can feel great and get to work, with less settle time. The ergonomic seat pan and subtle shell contours support movement in a working posture at a desk and sideways sitting. A gentle flex at the top of the shell opens the contours up for a reclining position. Generous waterfall seat front to support circulation to students' legs and feet.

- The shell rests on the frame, not rivets, to add comfort.
- Stacks 4-5 chairs high.
- High-density polypropylene with color throughout the shell.
- Durable swivel base glides with non-staining nylon bases and chrome-plated steel covers come standard.
- Choose optional steel or felt glides.
- The legs are strong, 14-gauge welded steel.
- Choose legs with durable chrome finish or platinum powder coat finish.
- Front and rear footrest bars (in platinum powder coat) protected against scuffing by a rugged plastic shell.

Stool Height Guide	
24" Stool	Use with 36" Table
30" Stool	Use with 40-42" Table

Model	Description	D"	W"	H"	F.C.	Cube	Wt.	UPS	List Price
33889	Groove 24" Fixed Stool	A shell – 24"h	18.5	19	24	125	2.0	12	\$ 149.00
33891	Groove 30" Fixed Stool	A shell – 30"h	18.5	19	30	125	2.0	13	\$ 155.00
<i>S</i>	Steel glide optional	Set of 4 installed							\$ upcharge
<i>F</i>	Felt glide optional	Set of 4 installed							\$ upcharge

Glide Options:

Nylon base glides are standard. Steel and Felt base glides are optional and are quoted.

This is factory installed option not available for field installation. Glide option must be on original chair order.

Steel glide option: Add '*S*' to follow Model No.

Felt glide option: Add '*F*' to follow Model No.

Chrome frame option: *CHR*

Platinum frame option: *PLT*

Groove Chair Shell Color Choice

Groove Chair Shell Color Choice						Frame
● Apple	● Burgundy	● Chocolate	● Fuchsia	● Navy	● Purple	● Chrome
● Black	● Cerulean	● Clementine	● Mint	● Orange	● Red	● Platinum
● Blueberry	● Charcoal	● Forest Green	● Persian Blue	● Yellow		

View all finish options on page 271.



Model 33841
Shown in Forest Green.

Groove Adjustable Chair

Immediately supportive and comfortable. Students can feel great and get to work, with less settle time. The ergonomic seat pan and subtle shell contours support movement in a working posture at a desk and sideways sitting. A gentle flex at the top of the shell opens the contours up for a reclining position. Generous waterfall seat front to support circulation to students' legs and feet.

- The shell rests on the frame, not rivets, to add comfort.
- Adjustable chair height from 16-21".
- High-density polypropylene with color throughout the shell.
- Available with 2" casters or glides.

Model	Description		D"	W"	H"	F.C.	Cube	Wt.	UPS	List Price
33840	Groove Adjustable Chair w/casters	A shell	25	25	16-21	85	2.1	26	*	\$ 253.00
33841	Groove Adjustable Chair w/glides	A shell	25	25	16-21	85	2.1	26	*	\$ 253.00



Model 33842
Shown in Red Shell.

Groove Adjustable Stool

Immediately supportive and comfortable. Students can feel great and get to work, with less settle time. The ergonomic seat pan and subtle shell contours support movement in a working posture at a desk and sideways sitting. A gentle flex at the top of the shell opens the contours up for a reclining position. Generous waterfall seat front to support circulation to students' legs and feet.

- The shell rests on the frame, not rivets, to add comfort.
- Adjustable height from 22-32".
- High-density polypropylene with color throughout the shell.
- Available with 2" casters or glides.

Model	Description		D"	W"	H"	F.C.	Cube	Wt.	UPS	List Price
33842	Groove Adjustable Stool w/casters	A shell	28	28	22-32	85	2.4	34	*	\$ 309.00
33843	Groove Adjustable Stool w/glides	A shell	28	28	22-32	85	2.4	34	*	\$ 309.00

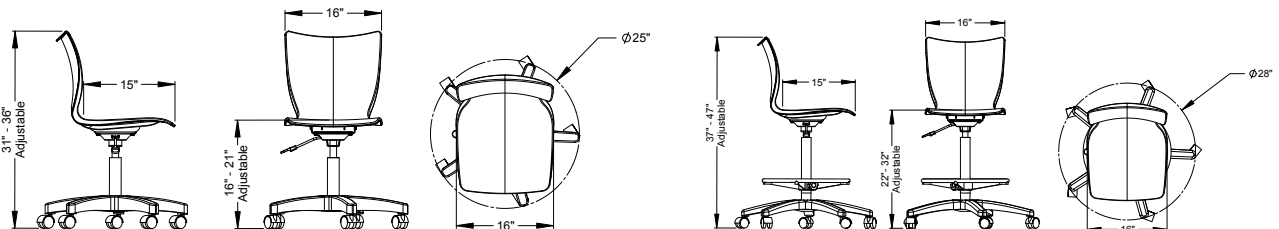

Adjustable Chair (A-Shell)

Adjustable Stool (A-Shell)

Seating Theorem®

A next-level chair
for students thinking
about their next level
of education.





Stack Chair



Mobile Stack Chair



Stack Chair with Arms



Mobile Stack Chair with Arms



Wire Rod Frame Chair



Wire Rod Frame Stool



Cantilever Base Chair



Adjustable Chair



Adjustable Stool

Grown-up thinking.

Older teens straddle high school and young adulthood. Though still “kids,” they don’t want anything childish, including classroom furniture. Smith System offers an answer with Theorem, a new seating line for young adult learners.

One for all.

Theorem serves high schoolers across the entire spectrum of body sizes and types. Theorem is ergonomically designed to give a smaller person the right amount of shell movement and give a larger person adequate support. Chair frames give strong support for the seat, but can also withstand some heavy handling.

Positioned for success.

Theorem’s two major seating positions – vertical and slight recline – are perfect to support high school learning. The chair’s seat is contoured 5.5 degrees, which is deeper than your typical stacking chair. This helps position the sitter’s weight back into the seat for a more supported upright sit. It also makes the angle between the top back and seat more shallow (about 90 degrees), so the sitter’s upper back is balanced over the lower spine; the lumbar region always stays in contact with the chair.

Nothing but nylon.

Rare in the pK-12 market, Theorem offers unmatched strength with a nylon shell. So even though Theorem’s one-piece shell is only 4 millimeters thick, it doesn’t need back ribbing or heavy hardware to be durable. That minimal depth also keeps the shell flexible and gives the chair a sleek profile and rearview, with clean, thin edges. This makes Theorem unlike anything currently on the pK-12 market.

Seating Theorem®





Model 44820
Shown in Platinum
with Chrome frame.

Theorem Wire Rod Frame Chair Available Summer 2020

A new seating line designed for 9th to 12th-grade students. Two major seating positions — working and slightly reclined — are perfect to support high school learning. Unlike traditional school chairs, Theorem provides the feeling of continuous support, whether the student is sitting up for table surface work or looking up to participate in discussions. Shell available in 10 colors, frame in chrome only. **Wire rod frame in chrome finish.

- The shell rests on the frame, not rivets, to add comfort.
- Unique nylon shell offering unmatched strength.
- Stacks four chairs high.

Model	Description	D"	W"	H"	F.C.	Cube	Wt.	UPS	List Price
44820	Theorem Rod Frame Chair	20	21	18	125	2.4	16	*	\$ 229.00



Model 44891
Shown in Persian Blue
with Chrome frame.

Theorem Wire Rod Frame Stool Available Summer 2020

A new seating line designed for 9th to 12th-grade students. Two major seating positions — working and slightly reclined — are perfect to support high school learning. Unlike traditional school chairs, Theorem provides the feeling of continuous support, whether the student is sitting up for table surface work or looking up to participate in discussions. Shell available in 10 colors, frame in chrome only. **Wire rod frame in chrome finish.

- The shell rests on the frame, not rivets, to add comfort.
- Unique nylon shell offering unmatched strength.
- Stacks four chairs high.
- Supportive crossbar serves as a footrest.

Model	Description	D"	W"	H"	F.C.	Cube	Wt.	UPS	List Price
44891	Theorem Rod Frame Stool	23	22	30	125	2.4	25	*	\$ 299.00

Theorem Chair Shell Color Choice

- Apple
- Burgundy
- Charcoal
- Orange
- Platinum
- Black
- Cerulean
- Navy
- Persian Blue
- Red

Frame

- Chrome

View all finish options on page 271.



Model 44849
Shown in Cerulean with Platinum frame.

Theorem Stack Chair

A new seating line designed for 9th to 12th-grade students. Two major seating positions — working and slightly reclined — are perfect to support high school learning. Unlike traditional school chairs, Theorem provides the feeling of continuous support, whether the student is sitting up for table surface work or looking up to participate in discussions. Shell available in 10 colors, frame in platinum only.

- The shell rests on the frame, not rivets, to add comfort.
- Unique nylon shell offering unmatched strength.
- The legs are strong, 14-gauge welded steel.
- Stacks four chairs high.

Model	Description	D"	W"	H"	F.C.	Cube	Wt.	UPS	List Price
44849	Theorem Stack Chair	20.5	19.5	18	125	2.7	15	*	\$ 169.00
F	Felt glide optional	Set of 4 installed		upcharge					

Glide Options:
Nylon base glides are standard. Felt base glides are optional and are quoted.

This is factory installed option not available for field installation. Glide option must be on original chair order.

Felt glide option: Add 'F' to follow Model No.
Platinum frame option: *PLT*



Model 44855
Shown in Navy with Platinum frame.

Theorem Mobile Stack Chair

A new seating line designed for 9th to 12th-grade students. Two major seating positions — working and slightly reclined — are perfect to support high school learning. Unlike traditional school chairs, Theorem provides the feeling of continuous support, whether the student is sitting up for table surface work or looking up to participate in discussions. Shell available in 10 colors, frame in platinum only.

- The shell rests on the frame, not rivets, to add comfort.
- Unique nylon shell offering unmatched strength.
- The legs are strong, 14-gauge welded steel.
- Stacks four chairs high.

Model	Description	D"	W"	H"	F.C.	Cube	Wt.	UPS	List Price
44855	Theorem Mobile Stack Chair	22	20	18	125	2.4	16	*	\$ 209.00



Model 44819
Shown in Apple with
Platinum frame.

Theorem 18" Stack Chair with Arms

Available Summer 2020

A new seating line designed for 9th to 12th-grade students. Two major seating positions — working and slightly reclined — are perfect to support high school learning. Unlike traditional school chairs, Theorem provides the feeling of continuous support, whether the student is sitting up for table surface work or looking up to participate in discussions. Shell available in 10 colors, frame in platinum only.

- The shell rests on the frame, not rivets, to add comfort.
- Unique nylon shell offering unmatched strength.
- Stacks four chairs high.

Model	Description	D"	W"	H"	F.C.	Cube	Wt.	UPS	List Price
44819	Theorem 18" Stack Chair with Arms	21	20	18	125	2.7	16	*	\$ 209.00



Model 44815
Shown in Black with
Platinum frame.

Theorem 18" Mobile Stack Chair with Arms

Available Summer 2020

A new seating line designed for 9th to 12th-grade students. Two major seating positions — working and slightly reclined — are perfect to support high school learning. Unlike traditional school chairs, Theorem provides the feeling of continuous support, whether the student is sitting up for table surface work or looking up to participate in discussions. Shell available in 10 colors, frame in platinum only.

- The shell rests on the frame, not rivets, to add comfort.
- Unique nylon shell offering unmatched strength.
- Stacks four chairs high.
- Available with 2" casters or glides.

Model	Description	D"	W"	H"	F.C.	Cube	Wt.	UPS	List Price
44815	Theorem 18" Mobile Stack Chair with Arms	22	21	18	125	2.4	17	*	\$ 239.00

Theorem Chair Shell Color Choice

- Apple
- Black
- Burgundy
- Cerulean
- Charcoal
- Navy
- Orange
- Persian Blue
- Platinum
- Red

Frame

- Platinum

View all finish options on page 271.



Model 44879
Shown in Burgundy
with Platinum frame.

Theorem Cantilever Chair

A new seating line designed for 9th to 12th-grade students. Two major seating positions — working and slightly reclined — are perfect to support high school learning. Unlike traditional school chairs, Theorem provides the feeling of continuous support, whether the student is sitting up for table surface work or looking up to participate in discussions. Shell available in 10 colors, frame in platinum only.

- The shell rests on the frame, not rivets, to add comfort.
- Unique nylon shell offering unmatched strength.
- Choose optional felt glides.
- The legs are strong, 12-gauge elliptical welded steel.

Model	Description	D"	W"	H"	F.C.	Cube	Wt.	UPS	List Price	
44879	Theorem Cantilever Chair	18.5	19	18	125	2.0	14	*	\$ 249.00	
<i>F</i>	Felt glide optional	Set of 4 installed								\$ upcharge

Glide Options:

Nylon base glides are standard. Felt base glides are optional and are quoted.

This is factory installed option not available for field installation. Glide option must be on original chair order.

Felt glide option: Add '*F*' to follow Model No.
Platinum frame option: *PLT*

Theorem Chair Shell Color Choice

- Apple
 - Burgundy
 - Charcoal
 - Orange
 - Platinum
- Black
 - Cerulean
 - Navy
 - Persian Blue
 - Red

Frame

- Platinum

View all finish options on page 271.



Model 44841
Shown in Apple Shell.

Theorem Adjustable Chair

A new seating line designed for 9th to 12th-grade students. Two major seating positions — working and slightly reclined — are perfect to support high school learning. Unlike traditional school chairs, Theorem provides the feeling of continuous support, whether the student is sitting up for table surface work or looking up to participate in discussions. Shell available in 10 colors, 5-star base in black.

- The shell rests on the frame, not rivets, to add comfort.
- Adjustable height from 22-32"
- Unique nylon shell offering unmatched strength.
- Available with 2" casters or glides.

Model	Description	D"	W"	H"	F.C.	Cube	Wt.	UPS	List Price
44840	Theorem Adjustable Chair w/casters	25	25	16-21	85	2.1	27	*	\$ 369.00
44841	Theorem Adjustable Chair w/glides	25	25	16-21	85	2.1	27	*	\$ 369.00



Model 44842
Shown in Red Shell.

Theorem Adjustable Stool

A new seating line designed for 9th to 12th-grade students. Two major seating positions — working and slightly reclined — are perfect to support high school learning. Unlike traditional school chairs, Theorem provides the feeling of continuous support, whether the student is sitting up for table surface work or looking up to participate in discussions. Shell available in 10 colors, 5-star base in black.

- The shell rests on the frame, not rivets, to add comfort.
- Adjustable height from 22-32"
- Unique nylon shell offering unmatched strength.
- Available with 2" casters or glides.

Model	Description	D"	W"	H"	F.C.	Cube	Wt.	UPS	List Price
44842	Theorem Adjustable Stool w/casters	28	28	22-32	85	2.4	35	*	\$ 579.00
44843	Theorem Adjustable Stool w/glides	28	28	22-32	85	2.4	35	*	\$ 579.00

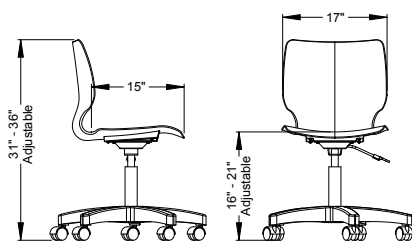

Adjustable Chair (A-Shell)

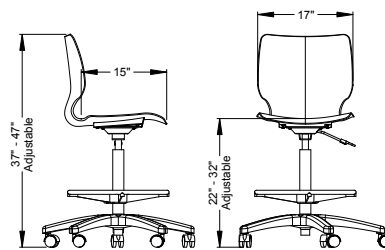
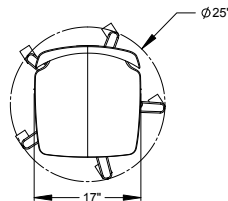

Adjustable Stool (A-Shell)

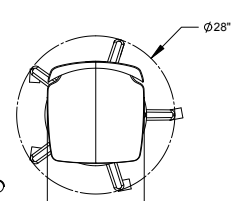

Seating Flavors®

A four-position chair
perfect for project
learning situations.





Stack Chair



Cantilever Chair



Mobile Stack Chair



Fixed Height Stool



Adjustable Stool



Adjustable Chair



Noodle Chair

Freedom of movement.

Flavors seating eliminates as many restrictions to student movement as possible.

- A relatively flat seatpan with a waterfall front allows the student to comfortably face front, back and either side.

Less restricting to the shoulders and spine.

To further enable the student to work with students on either side, the seatback provides torsional flex — allowing the student to gently twist to face left or right.

Move, breathe and concentrate.

A subtle front-to-back flex allows the student to move and adjust their posture, which promotes better concentration.

For classrooms that move and students of all sizes.

- Flavors seating is light enough for most students to move in the classroom without a problem.
- Achieve additional mobility with casters on the Adjustable Chair, Stools and Mobile Stacking Chair.
- Stacking models come in six sizes, so you can pair the appropriately sized chair with the student.

Construction. Built for the demands of a school environment.

- The durable, high-density polypropylene shell stands up to the challenges of a real-world classroom.
- Made of 18-gauge welded steel, the frame is protected with chrome plating or a rugged powder coat finish.
- For added comfort, the shell rests directly on the frame (not on the rivets).

Seating Flavors®



Model 11847
14" seat height,
'B' Shell.
Shown in Apple.

Model 11848
16" seat height,
'B' Shell.
Shown in Blueberry.

Model 11849
18" seat height,
'A' Shell.
Shown in Black.

Model 11844
8" seat height,
'C' Shell.
Shown in Cerulean.

Model 11845
10" seat height,
'C' Shell.
Shown in Purple.

Model 11846
12" seat height,
'C' Shell.
Shown in Navy.

Dimension Chart

Model	A	B	C	D	E	F	G	Leg Diameter
11844	17.5"	12.0"	13.5"	12.0"	15"	8"	11.00"	1"
11845	20.0"	12.0"	13.5"	12.0"	15"	10"	11.00"	1"
11846	22.0"	12.0"	14.5"	12.0"	15"	12"	11.00"	1"
11847	26.0"	14.5"	17"	14.5"	17.5"	14"	13.75"	1"
11848	28.5"	14.5"	18"	14.5"	17.5"	16"	13.75"	1"
11849	31.5"	16.0"	20.5"	16.0"	19.5"	18"	15.00"	1"

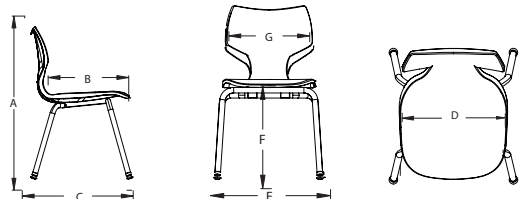



Flavors Stack Chair

Four-position chair allows student to sit comfortably facing front, either side or rear. Flexing seatback provides support and allows student to turn with less restriction. Flat seatpan with waterfall front edge. Six sizes. Available in 18 colors.

- The shell rests on the frame, not rivets to add comfort.
- High-density polypropylene with color throughout the shell.
- Durable swivel-base glides, with non-staining nylon bases and chrome-plated steel covers come standard.
- Choose optional steel or felt glides.
- The legs are strong, 18-gauge welded steel with a durable chrome finish.
- Chrome legs with durable chrome finish or Platinum powder coat finish.
- Stacks four chairs high.

Model	Description		D"	W"	H"	F.C.	Cube	Wt.	UPS	List Price
11844	Flavors Stack Chair	C shell – 8"h	13.5	15.0	8	125	1.2	5	*	\$ 90.00
11845	Flavors Stack Chair	C shell – 10"h	13.5	15.0	10	125	1.2	7	*	\$ 90.00
11846	Flavors Stack Chair	C shell – 12"h	14.5	15.0	12	125	1.2	7	*	\$ 95.00
11847	Flavors Stack Chair	B shell – 14"h	17.0	17.5	14	125	2.0	9	*	\$ 101.00
11848	Flavors Stack Chair	B shell – 16"h	18.0	17.5	16	125	2.0	9	*	\$ 105.00
11849	Flavors Stack Chair	A shell – 18"h	20.5	19.5	18	125	2.7	10	*	\$ 119.00
S	Steel glide optional	Set of 4 installed								upcharge
F	Felt glide optional	Set of 4 installed								upcharge

Glide Options:

Nylon base glides are standard. Steel and Felt base glides are optional and are quoted.

This is factory installed option not available for field installation. Glide option must be on original chair order.

Steel glide option: Add 'S' to follow Model No.

Felt glide option: Add 'F' to follow Model No.

Chrome frame option: CHR

Platinum frame option: PLT



Flavors Mobile Stack Chair

Four-position chair allows student to sit comfortably facing front, either side or rear. Flexing seatback provides support and allows student to turn with less restriction. Flat seatpan with waterfall front edge. Available in 18 colors.

- The shell rests on the frame, not rivets, to add comfort.
- High-density polypropylene with color throughout the shell.
- The legs are strong, 18-gauge welded steel.
- Chrome legs with durable chrome finish or Platinum powder coat finish.
- Mobile chairs recommended for use on carpeted flooring.

Model	Description		D"	W"	H"	F.C.	Cube	Wt.	UPS	List Price
11860	Flavors Mobile Stack Chair	B shell – 14"h	18.5	18	14	125	2.0	11	*	\$ 139.00
11854	Flavors Mobile Stack Chair	B shell – 16"h	19.5	18	16	125	2.0	11	*	\$ 139.00
11855	Flavors Mobile Stack Chair	A shell – 18"h	22	20	18	125	2.4	12	*	\$ 149.00

Flavors Chair Shell Color Choice

Flavors Chair Shell Color Choice						Frame
● Apple	● Burgundy	● Chocolate	● Fuchsia	● Navy	● Purple	● Chrome
● Black	● Cerulean	● Clementine	● Mint	● Orange	● Red	● Platinum
● Blueberry	● Charcoal	● Forest Green	● Mocha	● Persian Blue	● Yellow	

View all finish options on page 271.



Model 11879
18" seat height, 'A' Shell.
Shown in Persian Blue.

Flavors Cantilever Chair

Four-position chair allows student to sit comfortably facing front, either side or rear. Flexing seatback provides support and allows student to turn with less restriction. Flat seatpan with waterfall front edge. Available in 18 colors.

- The shell rests on the frame, not rivets, to add comfort.
- High-density polypropylene with color throughout the shell.
- The legs are strong, 12-gauge welded steel.
- Durable glides. Choose from nylon or felt.

Model	Description		D"	W"	H"	F.C.	Cube	Wt.	UPS	List Price
11879	Flavors Cantilever Chair	A shell – 18"h	21	19	18	125	2.4	12	*	\$ 179.00
<i>F</i>	Felt glide option	Set of 4 installed								no upcharge

Glide Options:

Nylon base glides are standard. Optional is felt base. Use felt for vct floors and nylon for carpet floors.

This is factory installed option not available for field installation. Glide option must be on original chair order.

Felt glide option: Add '*F*' to follow Model No.

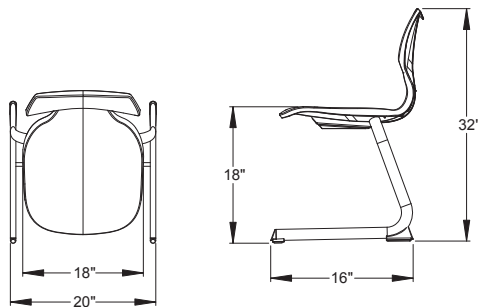

Flavors Chair Shell Color Choice

● Apple	● Burgundy	● Chocolate	● Fuchsia	● Navy	● Purple
● Black	● Cerulean	● Clementine	● Mint	● Orange	● Red
● Blueberry	● Charcoal	● Forest Green	● Mocha	● Persian Blue	● Yellow

Frame

● Chrome
● Platinum

View all finish options on page 271.



Seating Flavors®



Pair these fixed height stools with 36" h, 40" h and 42" h tables from our Interchange®, Planner® and Cafe table lines.

See pages 116, 168, 208

Model 11889

24" seat height.
Shown in Purple with Platinum frame.

Model 11890

28" seat height.
Shown in Apple with Platinum frame.

Flavors Stools

Fixed height. Four-position chair allows student to sit comfortably facing front, either side or rear. Flexing seatback provides support and allows student to turn with less restriction. Flat seatpan with waterfall front edge. Available in 18 colors.

- The shell rests on the frame, not rivets, to add comfort.
- High-density polypropylene with color throughout the shell.
- Durable swivel-base glides with non-staining nylon bases and chrome-plated steel covers come standard.
- Choose optional steel or felt glides.
- The legs are strong, 18-gauge welded steel.
- Choose legs with durable chrome finish or Platinum powder coat finish.
- Front and rear Footrest Bars (in Platinum powder coat) protected against scuffing by a rugged plastic shell.

Stool Height Guide	
24" Stool	Use with 36" Table
28" Stool	Use with 40-42" Table

Model	Description		D"	W"	H"	F.C.	Cube	Wt.	UPS	List Price
11889	Flavors Fixed Height Stool	A shell – 24"h	18.5	19	24	125	2.0	12	*	\$ 154.00
11890	Flavors Fixed Height Stool	A shell – 28"h	18.5	19	28	125	2.0	13	*	\$ 160.00
<i>S</i>	Steel glide optional	Set of 4 installed								\$ upcharge
<i>F</i>	Felt glide optional	Set of 4 installed								\$ upcharge

Glide Options:
Nylon base glides are standard. Steel and Felt base glides are optional and are quoted.

This is factory installed option not available for field installation. Glide option must be on original chair order.

Steel glide option: Add '*S*' to follow Model No.
Felt glide option: Add '*F*' to follow Model No.
Chrome frame option: *CHR*
Platinum frame option: *PLT*

Flavors Stool Shell Color Choice

● Apple	● Burgundy	● Chocolate	● Fuchsia	● Navy	● Purple	● Chrome
● Black	● Cerulean	● Clementine	● Mint	● Orange	● Red	● Platinum
● Blueberry	● Charcoal	● Forest Green	● Mocha	● Persian Blue	● Yellow	

View all finish options on page 271.



Model 11831
Shown in Orange Shell.
B-shell for grades 1-4
A-shell for grades 5+

Flavors Adjustable Chair

Flexing seatback provides support and allows student to turn with less restriction. Flat seatpan with waterfall front edge. Available in 18 colors. 5-star base in Black. Specify 'A' shell for grade 5+. B Shell has a gas lift that is specifically designed for elementary use, grades 1-4, less weight is required to activate the mechanism.

- Flavors seating adjustable chair height ranges from 16-21" for A shell; 14-16" for B shell.
- High-density polypropylene with color throughout the shell.
- Available with 2" casters or glides.
- The shell rests on the frame, not rivets, to add comfort.

Model	Description		D"	W"	H"	F.C.	Cube	Wt.	UPS	List Price
11840	Flavors Adjustable Chair w/casters	A shell	25	25	16-21	85	2.1	26	*	\$ 263.00
11841	Flavors Adjustable Chair w/glides	A shell	25	25	16-21	85	2.1	26	*	\$ 263.00
11830	Flavors Adjustable Chair w/casters	B shell	22	22	14-16	85	2.1	26	*	\$ 230.00
11831	Flavors Adjustable Chair w/glides	B shell	22	22	14-16	85	2.1	26	*	\$ 230.00



Model 11843
Shown in Red Shell.

Flavors Adjustable Stool

Flexing seatback provides support and allows student to turn with less restriction. Flat seatpan with waterfall front edge. Available in 18 colors. 5-star base in Black. Durable chrome footrest.

- Flavors Adjustable stool height ranges from 22-32".
- High-density polypropylene with color throughout the shell.
- Available with 2" casters or glides.
- The shell rests on the frame, not rivets, to add comfort.

Model	Description		D"	W"	H"	F.C.	Cube	Wt.	UPS	List Price
11842	Flavors Adjustable Stool w/casters	A shell	28	28	22-32	85	2.4	34	*	\$ 409.00
11843	Flavors Adjustable Stool w/glides	A shell	28	28	22-32	85	2.4	34	*	\$ 409.00

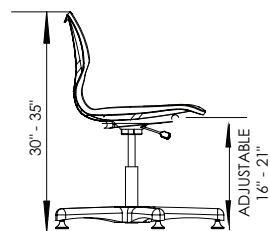

Adjustable Chair (A-Shell)

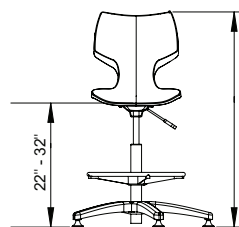
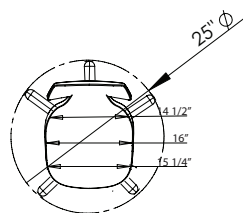

Adjustable Stool (A-Shell)

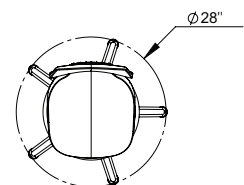

Student seating with patented movement.

Educators agree that allowing movement encourages better breathing and helps students concentrate. The Noodle Chair represents a practical solution for classrooms everywhere.



It feels like sitting on a ball that won't roll away.



The seatpan tilts front to back.



The seatpan tilts side to side.



See more:
smithsystem.com/noodle



Model 11851
18" seat height.
Shown in Apple Shell.



Model 11852
16" seat height.
Shown in Cerulean Shell.



Model 11853
14" seat height.
Shown in Red Shell.

Flavors Noodle Chair

The Noodle Chair is designed to help the student concentrate and be healthier. It has a patented suspension that allows it to move with — not resist — the student. It provides all the benefits of sitting on a large ball, but with the added advantages of more stability and back support. The Noodle Chair is perfectly suited to fidgety students. Available in 18 colors.

- The shell rests on a patented suspension, allowing the seatpan to tilt slightly in all directions.
- A four-position chair offering the utmost freedom of movement.
- High-density polypropylene shell with color throughout.
- Durable swivel-base glides with non-staining nylon bases and chrome-plated steel covers, come standard. Or choose optional felt or stainless steel glides.
- The legs are strong, 18-gauge welded steel with a durable chrome or platinum finish.



The seatpan tilts 7° side to side.

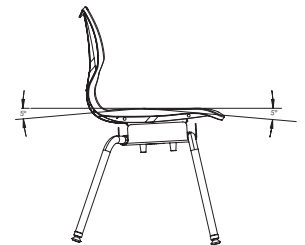

The seatpan tilts 5° front to back.

Model	Description		D"	W"	H"	F.C.	Cube	Wt.	UPS	List Price
11851	Flavors Noodle Chair	A shell – 18"h	20.5	19.5	18	125	2	15	*	\$ 199.00
11852	Flavors Noodle Chair	B shell – 16"h	18	18	16	125	1.2	14	*	\$ 189.00
11853	Flavors Noodle Chair	B shell – 14"h	17	17.5	14	125	1.2	14	*	\$ 189.00
<i>S</i>	Steel glide optional	Set of 4 installed								\$ upcharge
<i>F</i>	Felt glide optional	Set of 4 installed								\$ upcharge

Glide Options:

Nylon base glides are standard. Steel and Felt base glides are optional and are quoted.

This is factory installed option not available for field installation. Glide option must be on original chair order.

Steel glide option: Add '*S*' to follow Model No.

Felt glide option: Add '*F*' to follow Model No.

Chrome frame option: *CHR*

Platinum frame option: *PLT*

Flavors Noodle Chair Shell Color Choice

● Apple	● Burgundy	● Chocolate	● Fuchsia	● Navy	● Purple
● Black	● Cerulean	● Clementine	● Mint	● Orange	● Red
● Blueberry	● Charcoal	● Forest Green	● Mocha	● Persian Blue	● Yellow

Noodle Frame

● Chrome
● Platinum

View all finish options on page 271.

Seating Plato®

Its pronounced lumbar support promotes posture, breathing and attention.





Stack Chair



Mobile Stack Chair



Cantilever Chair



Fixed Height Stool



Adjustable Stool



Adjustable Chair

Support, with freedom.

Plato seating is a three-position chair, allowing the student to comfortably face the front and both sides. The “Euro-Spec” seatback draws on the design of European school seating where lumbar support is closely studied and mandated.

- The seatback flexes to provide relief from a fixed, rigid seating position.

Better posture and better breathing.

Studies show a link between improved student posture and a number of health benefits, including better breathing, as well as academic benefits, including better concentration.

A solid choice for classrooms of all kinds.

Plato seating is well-suited for collaborative classrooms as well as traditional classrooms. It allows students to work with others on either side, yet for individual study and lectures, it helps them stay alert and focused.

For classrooms of all kinds and students of all sizes.

- Plato seating is light enough for most students to move in the classroom without difficulty.
- Achieve additional mobility with casters on the Adjustable Chair, Adjustable Stools and the Mobile Stacking Chair.
- Stacking models come in three sizes so you can pair the appropriately sized chair with the student in all grade levels.

Construction. Built for the demands of a school environment.

- The durable, high-density polypropylene shell stands up to the challenges of a real-world classroom.
- Made of 18-gauge welded steel, the frame is protected with chrome plating.
- For added comfort, the shell rests directly on the frame (not on the rivets).

Seating Plato®



Model 00950
18" seat height, 'A' Shell.
Shown in Persian Blue.

Model 00951
16" seat height, 'B+' Shell.
Shown in Cerulean.

Model 00952
14" seat height, 'B' Shell.
Shown in Apple.

Plato Stack Chair

The Plato Stack Chair provides roominess for today's growing students through its oversized seatpan. Built to what's called Euro-Spec (short for European Specifications), the seatback offers some flex front-to-back and provides pronounced lumbar support, encouraging good posture and breathing. Its fresh, yet familiar shape connotes comfort to the student. 14", 16" and 18" sizes.

- The shell rests on the frame, not rivets, to add comfort.
- High-density polypropylene shell with color throughout.
- The legs are strong, 18-gauge welded steel with durable chrome or platinum* finish.
- Stacks 5-6 chairs high.
- Durable swivel-base glides with non-staining nylon bases and chrome-plated steel covers come standard. Or choose optional steel or felt glides.
- Available in 18 seat colors.

*Platinum frame available in 18" stack 00950 and 18" mobile stack 00953.

Model	Description		D"	W"	H"	F.C.	Cube	Wt.	UPS	List Price
00950	Plato Stack Chair	A shell – 18"h	21	19	18	125	4.0	11	*	\$ 119.00
00951	Plato Stack Chair	B+ shell – 16"h	18.25	17	16	125	4.0	9	*	\$ 105.00
00952	Plato Stack Chair	B shell – 14"h	16	15	14	125	4.0	8	*	\$ 101.00
F	Felt glide optional	Set of 4 installed								\$ upcharge
S	Steel glide optional	Set of 4 installed								\$ upcharge

Glide Options:
Nylon base glides are standard. Steel and Felt base glides are optional and are quoted.

This is factory installed option not available for field installation. Glide option must be on original chair order.

Steel glide option: Add 'S' to follow Model No.
Felt glide option: Add 'F' to follow Model No.

Plato seatpans are oversized for today's growing kids. Choose from A, B+ and B shells.

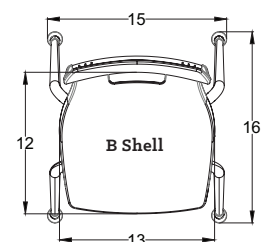
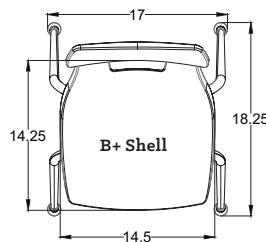
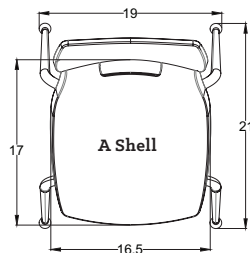



Model 00953
Shown in Purple.

Plato Mobile Stack Chair

The Plato Mobile Stack Chair provides roominess for today's growing students through its oversized seatpan. Built to what's called Euro-Spec (short for European Specifications) the seatback offers some flex front-to-back and provides pronounced lumbar support, encouraging good posture and breathing. Its fresh, yet familiar shape connotes comfort to the student. Mobility makes ingress/egress easier and allows classroom configurations to change quickly throughout the day.

- The shell rests on the frame, not rivets, to add comfort.
- High-density polypropylene shell with color throughout.
- Durable casters add mobility.
- The legs are strong, 18-gauge welded, steel with durable chrome or platinum finish.
- Stacks 5-6 chairs high.
- Available in 18 seat colors.

Model	Description	D"	W"	H"	F.C.	Cube	Wt.	UPS	List Price
00953	Plato Mobile Stack Chair	22	20	18	125		12	*	\$ 149.00



Model 00979
Shown in Persian Blue Shell with Chrome Frame.

Plato Cantilever Chair

Plato seating allows the student to comfortably face front and the side. The seatback offers some flex front-to-back and offers pronounced lumbar support, encouraging good posture and breathing on the part of the student.

- The shell rests on the frame, not rivets, to add comfort.
- High-density polypropylene with color throughout the shell.
- The legs are strong, 12-gauge welded steel.
- Use nylon glides for carpeted areas, felt for VCT and hard surfaces.

Model	Description	D"	W"	H"	F.C.	Cube	Wt.	UPS	List Price
00979	Plato Cantilever Chair	A shell	21	19	18	125	2.4	12	* \$ 179.00
F	Felt glide option	Set of 4 installed							no upcharge

Glide Options:
Nylon base glides are standard. Felt base glides are optional and are quoted.

This is factory installed option not available for field installation. Glide option must be on original chair order.

Felt glide option: Add 'F' to follow Model No.

Plato Chair Shell Color Choice

● Apple	● Burgundy	● Chocolate	● Fuchsia	● Navy	● Purple	● Chrome
● Black	● Cerulean	● Clementine	● Mint	● Orange	● Red	● Platinum*
● Blueberry	● Charcoal	● Forest Green	● Mocha	● Persian Blue	● Yellow	

View all finish options on page 271.

*Platinum frame available in 18" stack 00950, 18" mobile 00953 and Cantilever Base only 00979.



Model 00980
28" seat height. Shown in Forest Green, Platinum Frame.

Model 00981
24" seat height. Shown in Persian Blue, Platinum Frame.

Stool Height Guide	
24" Stool	Use with 36" Table
28" Stool	Use with 40-42" Table

Plato Fixed Height Stool

The Plato Fixed height Stool provides roominess for today's growing students through its oversized seatpan. Built to what's called Euro-Spec (short for European Specifications) the seatback offers some flex front-to-back and provides pronounced lumbar support, encouraging good posture and breathing. Its fresh, yet familiar shape connotes comfort to the student.

- The shell rests on the frame, not rivets, to add comfort.
- High-density polypropylene shell with color throughout.
- Durable swivel-base glides with non-staining nylon bases and chrome-plated steel covers come standard. Or choose optional steel or felt glides.

Model	Description		D"	W"	H"	F.C.	Cube	Wt.	UPS	List Price
00980	Plato Stool, Fixed Height	A shell – 28"h	21	19	28	125	18	18	*	\$ 160.00
00981	Plato Stool, Fixed Height	A shell – 24"h	21	19	24	125	16	16	*	\$ 154.00
S	Steel glide optional	Set of 4 installed								\$ upcharge
F	Felt glide optional	Set of 4 installed								\$ upcharge

Glide Options:
Nylon base glides are standard. Steel and Felt base glides are optional and are quoted.

This is factory installed option not available for field installation. Glide option must be on original chair order.

Steel glide option: Add 'S' to follow Model No.
Felt glide option: Add 'F' to follow Model No.
Chrome frame option: *CHR*
Platinum frame option: *PLT*
Add Model No.

Plato Chair Shell Color Choice

● Apple	● Burgundy	● Chocolate	● Fuchsia	● Navy	● Purple	● Chrome
● Black	● Cerulean	● Clementine	● Mint	● Orange	● Red	● Platinum
● Blueberry	● Charcoal	● Forest Green	● Mocha	● Persian Blue	● Yellow	

View all finish options on page 271.



Model 00960
Shown in Cerulean.



Model 00966
Shown in Cerulean.

Plato Adjustable Chair and Stool

The Plato Adjustable Chair provides roominess for today's growing students through its oversized seatpan. Built to what's called Euro-Spec (short for European Specifications), the seatback offers some flex front-to-back and provides pronounced lumbar support, encouraging good posture and breathing. Its fresh, yet familiar shape connotes comfort to the student.

- The shell rests on the frame, not rivets, to add comfort.
- High-density polypropylene shell with color throughout.
- 5-star base in Black.
- Choose glides or casters.
- Adjusts from 16-21" high (chair) and 22-32" high (stool).
- Available in 18 seat colors.

Model	Description	D"	W"	H"	F.C.	Cube	Wt.	UPS	List Price
00960	Plato Adjustable Chair w/glides	25	25	16-21	85	2.1	26	*	\$ 263.00
00961	Plato Adjustable Chair w/casters	25	25	16-21	85	2.1	26	*	\$ 263.00
00965	Plato Adjustable Stool w/glides	28	28	22-32	85	2.4	34	*	\$ 409.00
00966	Plato Adjustable Stool w/casters	28	28	22-32	85	2.4	34	*	\$ 409.00

Plato Chair Shell Color Choice

● Apple	● Burgundy	● Chocolate	● Fuchsia	● Navy	● Purple	● Black
● Black	● Cerulean	● Clementine	● Mint	● Orange	● Red	
● Blueberry	● Charcoal	● Forest Green	● Mocha	● Persian Blue	● Yellow	

View all finish options on page 271.

Seating In2it®

It comfortably directs
attention straight ahead.





For contemporary classrooms and students.

The In2it chair was designed to make the student feel comfortable before even sitting down through its use of familiar, graceful curves.

- The chair's inviting shape gives an honest indication of how comfortable it is.
- The bucket design provides great back and shoulder support while offering just the right amount of flex.

Built for the demands of a social environment.

- The durable, high-density polypropylene shell stands up to the challenges of a real-world classroom.
- Made of 18-gauge welded steel, the frame is protected with a rugged powder coat finish.
- For added comfort, the shell rests directly on the frame (not on the rivets).



Stack Chair



Mobile Chair



Adjustable Chair



Adjustable Stool

Seating In2it®



Model 00563
14" seat height, 'B' Shell.
Shown in Clementine.

Model 00562
16" seat height, 'B' Shell.
Shown in Fuchsia.

Model 00509
18" seat height, 'A' Shell.
Shown in Navy.

In2it Stack Chair

Its comfortable bucket seat design provides great support for the back and shoulders while comfortably orienting the student toward the front. Subtle flex in the In2it Chair's back provides some movement for the student, but movement to the sides and back is limited. Available in four sizes, 17 colors. Durable frame in Platinum.

- No sharp edges around handle.
- The light texture on the chair surface resists scratching.
- Mig-welded, 16-gauge steel frame.
- Swivel chrome plated glides come with nylon base. Or choose optional steel or felt glides.
- Stacks 5-6 chairs high.
- The shell rests on the frame, not on rivets.
- 2 shell sizes available: 'A' shell on 18" seat height and 'B' shell on 16" and 14" seat height.

Model	Description		D"	W"	H"	F.C.	Cube	Wt.	UPS	List Price
00509	In2it Stack Chair	A shell – 18"h	19.9	18.9	18	125	4	15	*	\$ 140.00
00562	In2it Stack Chair	B shell – 16"h	17.6	16.9	16	125	3.4	9	*	\$ 120.00
00563	In2it Stack Chair	B shell – 14"h	17.6	16.8	14	125	3.4	9	*	\$ 115.00
<i>S</i>	Steel glide optional	Set of 4 installed								\$ upcharge
<i>F</i>	Felt glide optional	Set of 4 installed								\$ upcharge

Glide Options:
Nylon base glides are standard. Steel and Felt base glides are optional and are quoted.

This is factory installed option not available for field installation. Glide option must be on original chair order.

Steel glide option: Add '*S*' to follow Model No.
Felt glide option: Add '*F*' to follow Model No.

Dimension Chart

Model	A	B	C	D	E	F
00509	19.85"	15.63"	30.41"	17.65"	18.89"	18"
00562	17.64"	12.8"	26.59"	15.69"	16.91"	16"
00563	17.64"	12.8"	25.1"	15.69"	16.84"	14"

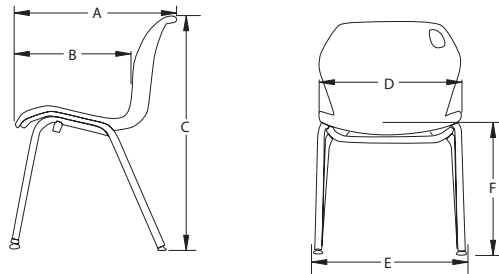

In2it Mobile Chair

Its comfortable bucket seat design provides great support for the back and shoulders while comfortably orienting the student toward the front. Subtle flex in the In2it Chair's back provides some movement for the student. Added casters allow the student to move with ease. Available in 17 colors.

Model	Description	D"	W"	H"	F.C.	Cube	Wt.	UPS	List Price
00507	In2it Mobile Chair A shell - 18"h	19.9	18.9	18	125	4	15	*	\$ 179.00



Model 00507
Shown in Persian Blue.



Model 00537
Shown in Persian Blue.

In2it Adjustable Chair and Stool

Its comfortable bucket seat design provides great support for the back and shoulders while comfortably orienting the student toward the front. Subtle flex in the In2it Chair's back provides some movement for the student. Swivel base allows student to face 360°. Seat height Adjustable. Available in 17 colors. Durable five-star base and frame in Black. Choose casters or glides. Black base only.

- Specify 'A' Shell for grades 5+ or adult use. • Available with 2" casters or glides.
- Specify 'B' Shell for grades 1-5, Elementary.
- 'B' Shell includes specifically designed gas lift that requires less weight to activate.

Model	Description	D"	W"	H"	F.C.	Cube	Wt.	UPS	List Price
00536	In2it Adj. Chair w/glides A shell	25	25	16-21	85		26	*	\$ 333.00
00537	In2it Adj. Chair w/2" casters A shell	25	25	16-21	85		26	*	\$ 333.00
00532	In2it Adj. Chair w/glides B shell	22	22	14-16	85		25	*	\$ 321.00
00533	In2it Adj. Chair w/2" casters B shell	22	22	14-16	85		25	*	\$ 321.00
00546	In2it Adj. Stool w/glides A shell	28	28	22-32	85		31	*	\$ 479.00
00547	In2it Adj. Stool w/2" casters A shell	28	28	22-32	85		31	*	\$ 479.00



Model 00547
Shown in Mint.

In2it Chair Shell

● Apple	● Burgundy	● Chocolate	● Fuchsia	● Navy	● Red	● Platinum
● Black	● Cerulean	● Clementine	● Mint	● Persian Blue	● Yellow	● Black (5-star base)
● Blueberry	● Charcoal	● Forest Green	● Mocha	● Purple		

View all finish options on page 271.

Seating Oodle®

A new revelation
for classroom
functionality.



See more:
meet-oodle.com



Stack



Mix



Move



Meet Oodle.

Often our pursuit of designs that inspire the minds of students takes us to places we never would have imagined even five or 10 years ago. One such result is here. Meet Oodle, the all-new active seating line that is as fun to explore as it is to say.

Switch it up.

Keep your space fresh by switching things up in a flash. You're never stuck with one height or one color. And the unique rocker base system maximizes versatility. Sit flat, or sit with movement, on the very same stool.

Moving up.

The colorful 6 1/2-inch sections stack and twist to engage a unique stool-to-stool locking system. Educators can easily assist students to make the stool taller or shorter.



Holding up.

Oodle's 17-inch diameter is perfect for all ages and sizes of student. Sturdy polypropylene material holds up to all elements.

Seating Oodle®

Choice of movement.



Make it move!

To add movement to Oodle, simply flip the movement disc over to the curved side, this will provide the student with a comfortable (and fun) 10 degrees of movement in all directions. Just the right amount — Oodle never feels unstable.



Make it stop!

Let's face it, active seating isn't for every student (or every situation), for those students and situations, the movement disc is easy for a teacher to flip and remove the movement from Oodle. To stack Oodle or sit flat, turn the movement disc over to the flat side and lock into place.

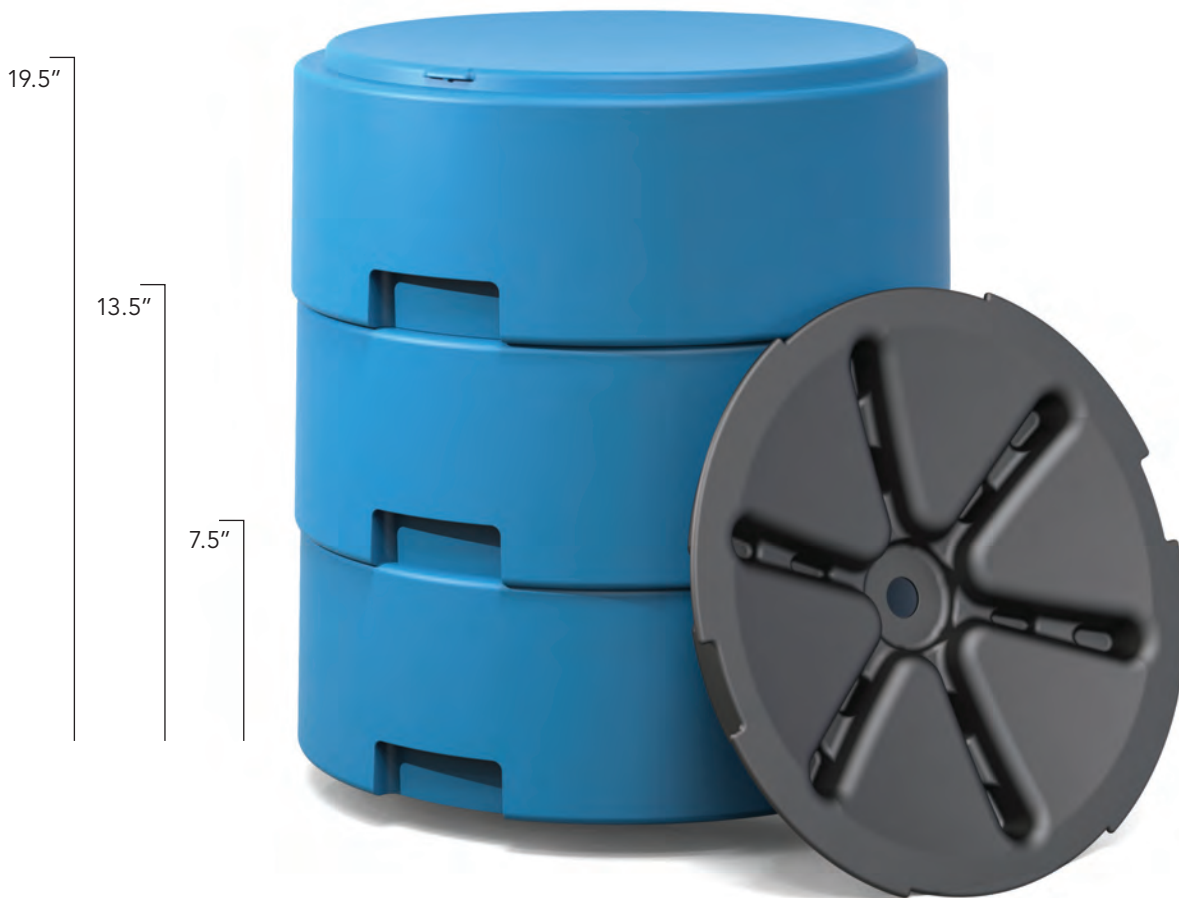

Oodle Movement Disc

Patent pending. Movement Disc is inserted and locked into base. Flip 180° for no movement.



See more:
meet-oodle.com

Oodles of possibilities.

The unique base design incorporates a structural disc that when flipped 180 degrees provides the student with the ability to wiggle. Or, if the student or teacher chooses, sit flat. Model Oodle31 comes with three sections and one rocker base. Model Oodle33 comes with three sections and three rocker bases.





Oodle Stools and Elemental 6-Star Table
Oodle stools shown in Apple, Charcoal and Platinum.

Mix, match and stack.

To stack, rearrange your colors or use Oodle in different configurations. Restacking is a breeze, just find the circular indicator and snap Oodle into place.

Pair Oodles with matching tables from our Elemental® and Planner® Studio lines or match edge band colors from our Interchange® table line.

Choice of height.

Because Oodle comes in three 6 1/2-inch sections, teachers don't have to be stuck with a single height stool in their classrooms and commons areas. And students are free to choose the height they feel most comfortable with for the activity at that moment. For example, four 19 1/2-inch Oodles can be used as six 13 1/2-inch Oodles in the morning, and twelve 7 1/2-inch Oodles in the afternoon.

See pages 88, 122, 168

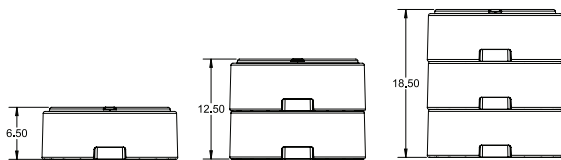

Height with Rocker Base Disengaged

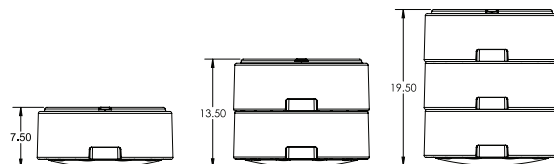

Height with Rocker Base Engaged



Oodle seating paired with Elemental Tables and Flavors Seating.

All students welcome.

Students come in all shapes and sizes. In the design of Oodle, we considered every body type. With 17 inches of seating surface, larger students will feel just as welcome using an Oodle.



Seat diameter measures 17" Ensuring every student feels comfortable, weight limit 250lbs.

Comfortable motion.

Featuring a modest 10 degrees of motion, Oodle's edge is designed to catch a student before he or she is able to lose their balance. And, of course, motion is optional on Oodle.



Oodle moves only so far before the built in 'stop' engages at 10° of rocking. This prevents the user from feeling unstable.

Model	Description	D"	W"	H"	F.C.	Wt.	UPS	List Price
OODLE31_ _ _	Stack of Three with One Movement Disc	17dia.	6.5 – 19.5"		125	19.5	*	\$ 199.00
OODLE33_ _ _	Stack of Three with Three Movement Discs	17dia.	6.5 – 19.5"		125	25.5	*	\$ 249.00
OODLEBASECGR	Movement Disc Only*	17dia.	1"		125	3	*	\$29.00
OODLEFELT	Adhesive Felt Pad for Hard Floor Surfaces**						*	\$15.00

Oodle Color Choice

- Apple **APL**
- Cerulean **CER**
- Charcoal **CGR**
- Orange **ORG**
- Platinum **PLT**

Oodle ships in a single color, to mix colors order multiple stools.

*Movement Disc available in Charcoal only.
**Specify Felt for Use on hard surface flooring.

Seating Soft Rocker

Rock longer.
Rock softer.





Something soft from Smith System.

For kids in need of action, we introduce our first soft-finish rocking chair. The Soft Rocker provides open, multi-position seating ideal for engagement across learning environments. To complement the Soft Rocker, we've also designed a soft finish, multi-purpose ottoman. Together, the Soft Rocker and Ottoman are the perfect complement to any classroom or commons area and provide a higher class of comfort and durability for kids at every age.

Soften your space.

Add a new element of comfort with the Soft Rocker and Ottoman. The Soft Rocker provides a functional and mobile experience that keeps kids in comfort and collaboration even longer.

Rock the day.

Just as kids are built to move, so is this rocker. Help kids get more out of their learning environment by creating space for everyone.

Built to last.

The highly durable, highly washable polyurethane fabric suits classrooms of all ages and easily wipes down at the end of the day.

Seating Soft Rocker

NEW!



Model 55000
Shown in Sprout and Oriole fabric.

Soft Rocker

The Soft Rocker offers a new style of movement-based active seating. The rocking action promotes engaging interaction with others. Children, adolescents and even adults love the rocking motion of the Soft Rocker.

The Soft Rocker is constructed of durable, kiln-dried, solid hardwood with a poplar plywood frame, which is corner blocked at load-bearing connections. The back frame is webbed for structural integrity. The seating pad is made from high-density foam meeting FR CA117 standards and contains no added flame retardant chemicals.

- Momentum Textiles 100% EPU polyurethane fabric.
- 900,000 D.R. Durability rating.
- CA117.
- Polyester fabric backing.
- Easily cleanable with a 4:1 water:bleach mixture.

Model	Description	D"	W"	H"	F.C.	Cube	Wt.	UPS	List Price
55000	Soft Rocker Chair	26.25	20.55	25.42	70	1	18	*	\$ 699.00

Soft Rocker Color Choice

- Sprout
- Geyser
- Eclipse
- Oriole
- Forge



See more:
smithsystem.com/softrocker

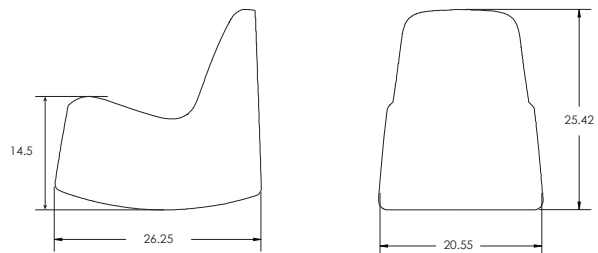



Seating Ottoman

NEW!



Create a fresh space for flexible—
and rockable—learning.



Ottoman

The 26" ottoman pairs well with our Soft Rocker or on its own to create comfortable work spaces for young adult learners. Collaborate with others and interact in a close-knit space. The ottoman is constructed of durable kiln-dried pine solid hardwood with a poplar plywood frame, which is corner blocked at load-bearing connections. The back frame is webbed for structural integrity. The seating pad is made from high-density foam meeting FR CA117 standards and contains no added flame retardant chemicals.

- Momentum Textiles 100% EPU polyurethane fabric
- Easily cleanable with a 4:1 water:bleach mixture.
- 900,000 D.R. Durability rating.
- CA117.
- Polyester fabric backing

Model	Description	D"	W"	H"	F.C.	Cube	Wt.	UPS	List Price
55001	26" dia. Ottoman	26dia.	26	15	70	1	19	*	\$ 649.00

Ottoman Color Choice

- Sprout
- Geyser
- Eclipse
- Oriole
- Forge

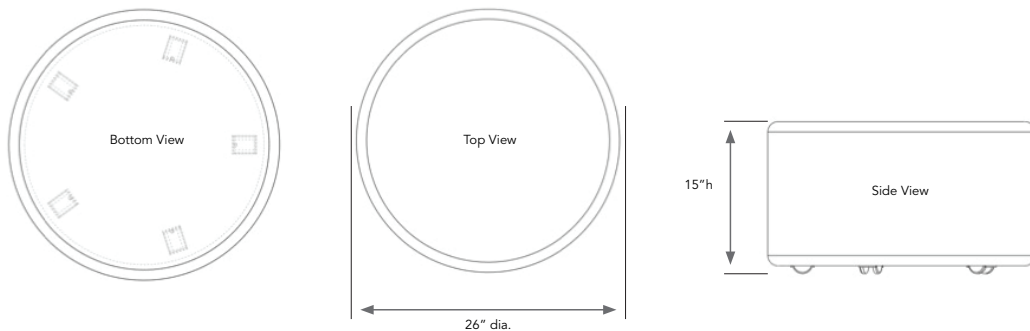

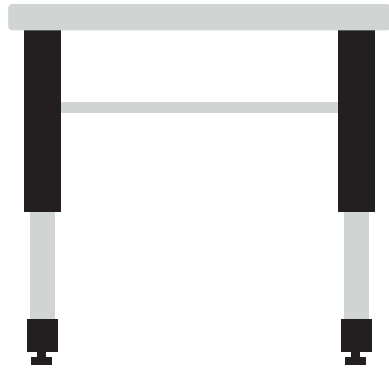

Desks & Tables

Today's learning environments present an unprecedented challenge to desks and tables, demanding greater versatility and durability. Our desks and tables are designed for multiple reconfigurations — pods, pairs, rows and more — and are reinforced to withstand the constant movement.

Built for Learning.





Desks & Tables



Interchange®

See page 88



Elemental®

See page 122



UXL®

See page 142



Silhouette®

See page 154



Planner®

See page 168



Meeting Tables

See page 204

Beyond design, consider how it's engineered and built.

Mobile

In collaborative learning classrooms, students have to be able to move desks and tables without help.

Reconfigurable

Today, the shape of desk and table work surfaces must allow the furniture to fit into a compact pod for small group work and work in pairs, or make them suitable for individual work.

Future Proof

Desks and tables are moved constantly. They must be built strong to withstand this use well into the future. Their shapes must add functionality with future use in mind, rather than contributing gimmicky, non-functional arrangements in the classroom. Learn more at smithsystem.com/collaborative-desks.

Functionality

- "Pie-shaped" desktops allow students to make compact pods for working in groups.
- Casters provide needed mobility for the desk — don't make students drag them across the floor.
- The suggested minimum workspace is 27 inches.

Durability

- Structural Framing — steel reinforcing beams attach to each leg, adding rigidity and preventing wobbly legs. Don't settle for Easy On Brackets on tables and desks in collaborative learning classrooms.
- The T-Mold edge band, used on Smith System Desks and Tables, is stapled every 6 inches to provide superior fastening power.

Right Size

Fitting the chair and desk or table to the student is important, as a proper fit helps academic performance while a poor fit hinders it.



27in. Suggested minimum workspace

Healthy Construction

Smith System desks and tables are made for healthy learning environments, and are UL GREENGUARD Gold Certified.

Suggested Desk and Chair Heights:

Table Height	~19"	~22"	~24"	~27"	~29"
Chair Height	10"	12"	14"	16"	18"
3-4 year olds	50%	50%			
Kindergarten		50%	50%		
Grade 1			100%		
Grade 2			25%	75%	
Grade 3-4				100%	
Grade 5				50%	50%
Grade 6-12					100%

Dependability

Smith System backs its tables and desks with a lifetime warranty on the frame and legs and a 12-year warranty on tabletops and desktops.

Availability

Smith System employs lean manufacturing techniques, allowing us to make tables and desks to order and Quick Ship them.

Desks & Tables Interchange®

Unique surfaces to
create an unlimited
number of possibilities.





Wing Desks



Diamond Desks



3-2-1 Desk



Student Desks



Squiggle Table



Cookie Table



Crescent Table



Multimedia Tables

Contemporary styling, solid functionality and innovative desktop designs.

For 21st century classrooms.

Its unique combination of functionality, style and practicality gives the Interchange line its innate unity and beauty.

- Interchange Wing, Diamond and 3-2-1® Desks for collaborative learning (and traditional) classrooms.
- Interchange Student Desks for traditional classrooms.

Dependability.

Lifetime warranty on the frame and legs, 12-year warranty on table and desktops.

Healthy construction.

UL GREENGUARD Gold Certified.

Unbeatable construction.

- The T-Mold edge band, used on Interchange Desks and Tables, is stapled every 6 inches to provide superior fastening power.
- The work surfaces are high-pressure laminate that stand up to heavy use.
- Structural Framing — steel reinforcing beams attached to each leg — adding rigidity and preventing wobbly legs. Don't settle for Easy On Brackets for tables and desks in collaborative learning classrooms.



Interchange® Wing Desk



Wing Desks shown at 34" h with 24" h Flavors Fixed height Stools, Model 11889. Shown in Asian Night top with Apple edge and Platinum frame.



All Interchange Desks can be set at 34" h on a glide or 37" h on casters for use with a 24" stool or standing.



The unique shape of Interchange Wing Desks allows you to oppose desks in a compact area, or in rows for lectures, testing or individual work.



Shown in Classic Linen top with Persian Blue edge and Platinum frame. Shown with optional Flavors Stack Chair, Model 11849.



Shown in Classic Linen top with Persian Blue edge and Platinum frame.

Interchange Wing Desk

This compact, contemporary desk designed for collaborative learning provides sleek looks, solid functionality and great flexibility. It can be arranged in countless ways for groups of all sizes. Its work surface provides ample space for work of all kinds. Order it in any of 14 standard laminate colors, 20 edge colors and Black or Platinum frame.

- Durable desktop available in 1 1/4" or 3/4" thickness, with a high-pressure laminate surface.
- Rugged powder coat surface on legs resists wear.
- Chrome-plated lower legs of 16-gauge steel resist scuffing.
- Sock-style glide caps add protection.
- 1" adjustable leveling glides provide stability on uneven floors.
- Backpack hook is standard, attached to the structural framing of the Wing Desk.

Model	Description	D"	W"	H"	F.C.	Cube	Wt.	UPS	List Price
03095	Interchange Wing Desk	23.5	41	22-34	70	2.4	45	*	\$ 242.00
Optional Accessories									
66013	Interchange SW (Standard Width) Tote Tray w/housing	16.8	13.5	4.48	70		10		\$ 88.00
66014	Interchange SW (Standard Width) housing only	16.8	13.5	4.48	70		8		\$ 68.00

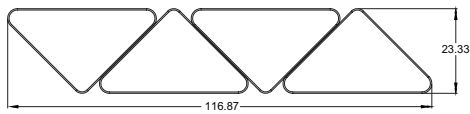

Linear Arrangement

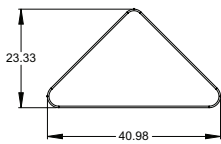

Model 03095
Top Down View

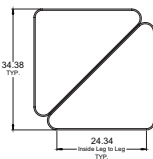

2-Grouping

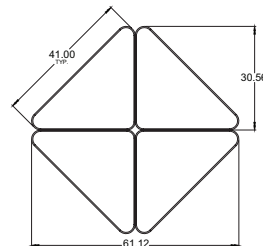

4-Grouping

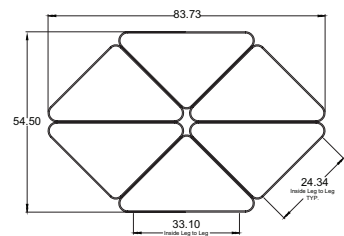

6-Grouping Circle



Model 03095
available with optional Cascade® standard width tote.



Make it mobile with casters
Order Model 17576
\$ 76.00 List



Mix Wing & Swoop Wing Desks
Swoop Wing page 93



Interchange Swoop Wing Desk

This compact, contemporary desk designed for collaborative learning provides sleek looks, solid functionality and great flexibility. It can be arranged in countless ways for groups of all sizes. The swoop in the work surface provides a sense of place for the student. Order it in any of 14 standard laminate colors, 20 edge colors and Black or Platinum frame.

Model	Description	D"	W"	H"	F.C.	Cube	Wt.	UPS	List Price
03097	Interchange Swoop Wing Desk	23.5	41	22-34	70	2.4	43	*	\$ 245.00

*Totes and bookboxes are not compatible with Swoop Wing Desk.

Shown in New Age Oak top with Clementine edge and Platinum frame.

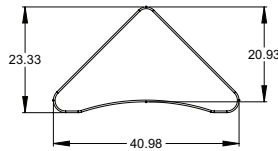

Top Down View



Linear Arrangement

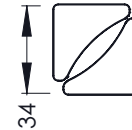

2-Grouping

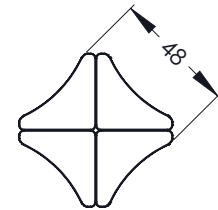

4-Grouping Circle

Interchange Student Desks Have Top and Edge Choices

- 1 1/4" Tops**
- CHOICE 1** – 1 1/4" top with Bumper T-Mold no letter to follow Model No.
 - CHOICE 2** – 1 1/4" top with 4mm T-Mold **D** to follow Model No.
- 3/4" Tops**
- CHOICE 3** – 3/4" top with 4mm T-Mold **C** to follow Model No.
 - CHOICE 4** – 3/4" top with Bullet T-Mold **V** to follow Model No.



The details that set us apart.

All Smith System Collaborative Desks have structural framing which prevents wobbly legs and contributes to a longer service life.

Interchange Laminate Color Choice

Interchange Laminate Color Choice					Leg Color Choice
● Asian Night	● Classic Linen	● Palisades Oak	● New Age Oak	● Grey Nebula	● Black
● Boardwalk Oak	● High Rise	● Flax Linen	● Wild Cherry	● French Pear	● Platinum
● Pewter Mesh	● Buka Bark	● Mission Maple	● Fusion Maple		

Interchange Edge Color Choice

● Apple	● Burgundy	● Charcoal	● Forest Green	● Mocha	● Persian Blue	● Red
● Black	● Cerulean	● Chocolate	● Fuchsia	● Navy	● Platinum	● Yellow
● Blueberry	● Champagne	● Clementine	● Mint	● Orange	● Purple	

View all finish options on page 271.

Desks Interchange®



Shown in High Rise top with Cerulean edge and Platinum frame.

Interchange Wing Open Front Desk

This flexible contemporary desk provides both sleek looks and solid functionality. Its space-saving desktop provides ample work space and allows it to create compact groups of four. It offers the convenience of a built-in Bookbox, and can be ordered in any of 14 standard laminate colors, 20 edge colors and Black or Platinum frame.

- Interchange Open Front Desks are made with your choice of bumper edge tops.
- Edge moldings resist wear, choices available (see chart, below).
- Rugged powder coat surface on legs resists wear.
- Chrome-plated lower legs of 16-gauge steel resist scuffing.
- Sock-style glide caps add protection.
- 1" adjustable leveling glides provide stability on uneven floors.

Model	Description	D"	W"	H"	F.C.	Cube	Wt.	UPS	List Price
04503	Interchange Wing Open Front Desk	23.5	41	22-32	70	2.4	50	*	\$ 340.00

Optional Accessories									
67638	Backpack Hook							*	\$ 8.00

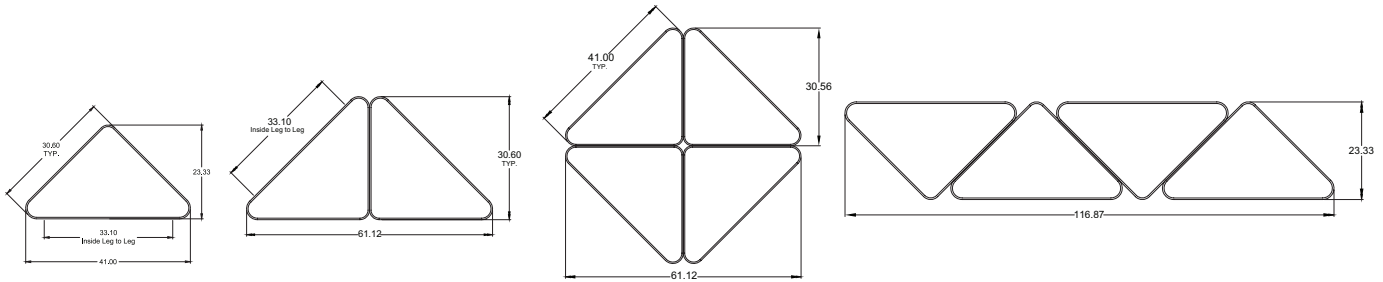

Interchange Open Front Desks Have Top and Edge Choices

- 1 1/4" Tops**
- CHOICE 1** – 1 1/4" top with Bumper T-Mold no letter to follow Model No.
 - CHOICE 2** – 1 1/4" top with 4mm T-Mold **D** to follow Model No.
- 3/4" Tops**
- CHOICE 3** – 3/4" top with 4mm T-Mold **C** to follow Model No.
 - CHOICE 4** – 3/4" top with Bullet T-Mold **V** to follow Model No.



Make it mobile with casters
Order Model 17576
\$ 76.00 List

Interchange Laminate Color Choice

- | | | | | |
|-----------------|-----------------|-----------------|----------------|---------------|
| ● Asian Night | ● Classic Linen | ● Palisades Oak | ● New Age Oak | ● Grey Nebula |
| ● Boardwalk Oak | ● High Rise | ● Flax Linen | ● Wild Cherry | ● French Pear |
| ● Pewter Mesh | ● Buka Bark | ● Mission Maple | ● Fusion Maple | |

Leg Color Choice

- Black
- Platinum

Interchange Edge Color Choice

- | | | | | | | |
|-------------|-------------|--------------|----------------|----------|----------------|----------|
| ● Apple | ● Burgundy | ● Charcoal | ● Forest Green | ● Mocha | ● Persian Blue | ● Red |
| ● Black | ● Cerulean | ● Chocolate | ● Fuchsia | ● Navy | ● Platinum | ● Yellow |
| ● Blueberry | ● Champagne | ● Clementine | ● Mint | ● Orange | ● Purple | |

View all finish options on page 271.

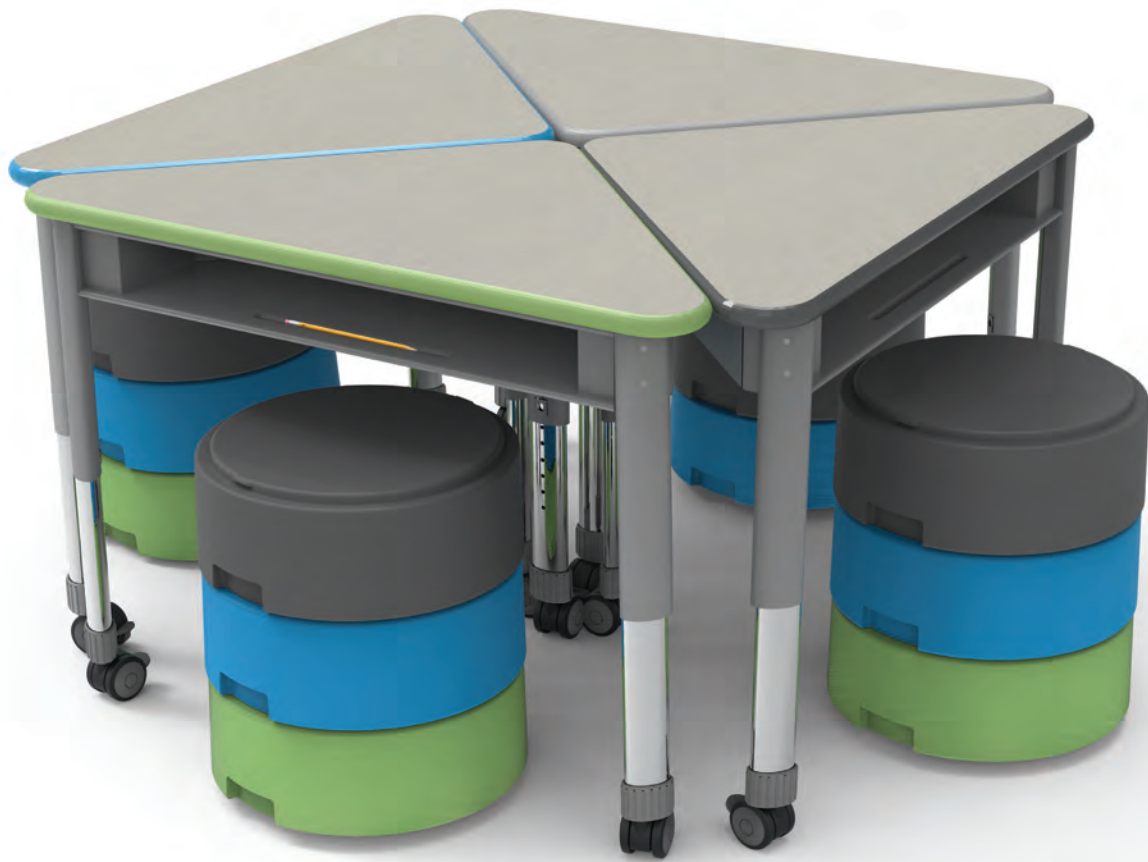

Shown in Classic Linen top with Apple, Cerulean, Platinum & Charcoal edges with Platinum frames. Shown with optional Oodle® stools, **Models OODLE31 CER, OODLE31 CGR & OODLE31 APL** (mixed together to create multi-color stools). See page 72.

Optimize classroom space with Interchange Wing Desks.

Interchange Wing Desks allow great flexibility when it comes to creating compact pods of two, three and four students. The flexibility comes from the shape of the desktop. Its pie shape allows four students to work in a very compact area. Three students, even smaller. Two students can work almost side-by-side, facing or at an angle — whichever suits their activity.



Optional Backpack Hook
Model 67638 \$ 8.00

Keeps floors tidy and backpacks handy.

Desks Interchange®



Six Interchange Diamond Desks form a compact group with ample space to work. Shown with optional Apple Casters, 17577.



Put two Interchange Diamond Desks together and students can work in a pair.



Three Interchange Diamond Desks approximate a semi-circle for three students.

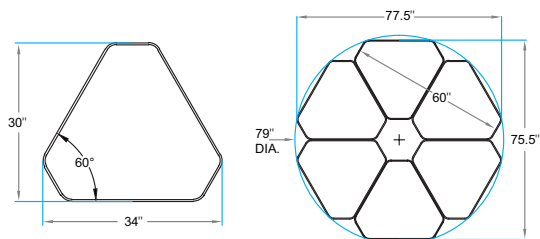

Model 03082. Interchange Diamond Student Desk

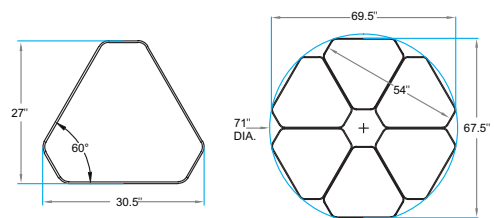

Model 03083. Interchange Mini Diamond Student Desk

Interchange Diamond Desks

This contemporary desk designed for collaborative learning classrooms provides sleek looks and solid functionality. It can be arranged in compact groups of up to six. Its large work surface provides ample space for projects and work of all kinds. Order in any of 14 standard laminate colors, 20 edge colors and Black or Platinum frame.

- Durable desktop available in 1 1/4" or 3/4" thickness, with a high-pressure laminate surface.
- Edge moldings resist wear, choices available (see chart).
- Rugged powder coat surface on legs resists wear.
- 1" adjustable leveling glides provide stability on uneven floors.
- Adjustable desk height, adjusts in 1" increments. Only three (not four) legs to adjust on Single-Student Diamond Desk.

Model	Description	D"	W"	H"	F.C.	Cube	Wt.	UPS	List Price
03082	Interchange Diamond Desk	30	34	22-34	70	2.7	49	*	\$ 243.00
03083	Interchange Mini Diamond Desk*	27	30.5	22-34	70	2.7	42	*	\$ 238.00
Optional Accessories (for #03082/#03083)									
66013	Interchange SW (Standard Width) Tote Tray w/housing	16.8	13.5	4.48	70		10		\$ 88.00
66014	Interchange SW (Standard Width) housing only	16.8	13.5	4.48	70		8		\$ 68.00

*Accommodates up to 18" h stack chair.



Crucial for desks in collaborative learning classrooms, Structural Framing provides a stronger work surface and prevents legs from wobbling.



Diamond Desk — Model 03082
Shown in Boardwalk Oak top with Apple Edge. Optional colored casters (17577APL) and Optional SW Tote (66013).



Make it mobile with casters
Order Model 17576
\$ 76.00 List

Interchange Desks Have Top and Edge Choices

1 1/4" Tops

CHOICE 1 – 1 1/4" top with Bumper T-Mold
no letter to follow Model No.

CHOICE 2 – 1 1/4" top with 4mm T-Mold
D to follow Model No.

3/4" Tops

CHOICE 3 – 3/4" top with 4mm T-Mold
C to follow Model No.

CHOICE 4 – 3/4" top with Bullet T-Mold
V to follow Model No.

Interchange Laminate Color Choice

● Asian Night	● Classic Linen	● Palisades Oak	● New Age Oak	● Grey Nebula
● Boardwalk Oak	● High Rise	● Flax Linen	● Wild Cherry	● French Pear
● Pewter Mesh	● Buka Bark	● Mission Maple	● Fusion Maple	

Leg Color Choice

● Black
● Platinum

Interchange Edge Color Choice

● Apple	● Burgundy	● Charcoal	● Forest Green	● Mocha	● Persian Blue	● Red
● Black	● Cerulean	● Chocolate	● Fuchsia	● Navy	● Platinum	● Yellow
● Blueberry	● Champagne	● Clementine	● Mint	● Orange	● Purple	

View all finish options on page 271.



Model 04504
Shown in Flax Linen top with Apple edge and Platinum frame.

Interchange Diamond Open Front Desks

This flexible contemporary desk provides both sleek looks and solid functionality. Its space-saving desktop provides ample work space and allows it to create compact groups of four. It offers the convenience of a built-in Bookbox, and can be ordered in any of 14 standard laminate colors, 20 edge colors and Black or Platinum frame.

- Interchange Open Front Desks are made with your choice of bumper edge tops.
- Edge moldings resist wear, choices available (see chart, below).
- Rugged powder coat surface on legs resists wear.
- Chrome-plated lower legs of 16-gauge steel resist scuffing.
- Sock-style glide caps add protection.
- 1" adjustable leveling glides provide stability on uneven floors.

Model	Description	D"	W"	H"	F.C.	Cube	Wt.	UPS	List Price
04504	Interchange Diamond Open Front Desk	30	34	22-32	70	2.7	58	*	\$ 375.00
04505	Interchange Mini Diamond Open Front Desk	27	30.5	22-32	70	2.7	50	*	\$ 365.00
Optional Accessories									
67638	Backpack Hook							*	\$ 8.00

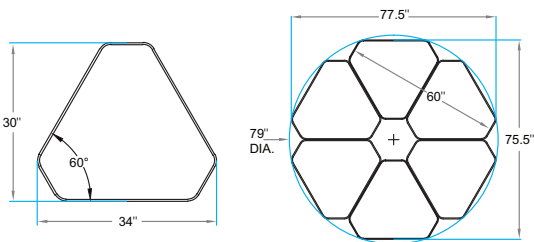

Model 04504. Interchange Diamond Student Desk

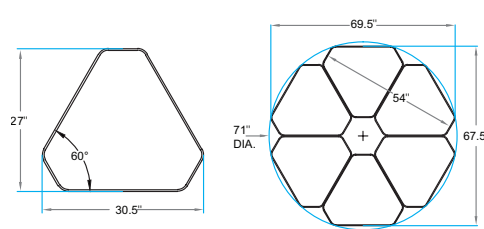

Model 04505. Interchange Mini Diamond Student Desk

Interchange Open Front Desks Have Top and Edge Choices

1 1/4" Tops

CHOICE 1 – 1 1/4" top with Bumper T-Mold no letter to follow Model No.

CHOICE 2 – 1 1/4" top with 4mm T-Mold **D** to follow Model No.

3/4" Tops

CHOICE 3 – 3/4" top with 4mm T-Mold **C** to follow Model No.

CHOICE 4 – 3/4" top with Bullet T-Mold **V** to follow Model No.

Make it mobile with casters
Order Model 17576 \$ 76.00 List

Interchange Laminate Color Choice

- Asian Night
- Boardwalk Oak
- Pewter Mesh
- Classic Linen
- High Rise
- Buka Bark
- Palisades Oak
- Flax Linen
- Mission Maple
- New Age Oak
- Wild Cherry
- Fusion Maple
- Grey Nebula
- French Pear

Leg Color Choice

- Black
- Platinum

Interchange Edge Color Choice

- Apple
- Black
- Blueberry
- Burgundy
- Cerulean
- Champagne
- Charcoal
- Chocolate
- Clementine
- Forest Green
- Fuchsia
- Mint
- Mocha
- Navy
- Orange
- Persian Blue
- Platinum
- Purple
- Red
- Yellow

View all finish options on page 271.



Model 04505

Shown in Grey Nebula top with Cerulean edge and Black frame, with Flavors Mobile Chairs, Model 11855 and optional Charcoal Casters, Model 17577.



Optimize classroom space with Interchange Diamond Desks.

Interchange Diamond Desks allow great flexibility when it comes to creating compact pods of two, three and four students. The flexibility comes from the shape of the desktop. Its pie shape allows four students to work in a very compact area. Three students, even smaller. Two students can work almost side-by-side, facing or at an angle — whichever suits their activity.



Optional Backpack Hook
Model 67638 \$ 8.00

Keeps floors tidy and backpacks handy.

Desks Interchange®

Shown in Asian Night top with Charcoal edge and Platinum frame with Plato Mobile Chairs in Fuchsia.



Interchange Two-Student Diamond Desk





This contemporary desk designed for collaborative learning classrooms provides sleek looks and solid functionality. Its large work surface provides ample space for two students and work of all kinds. Now available with Cascade standard width (SW) Tote Tray Kit.



Shown in Pewter Mesh top with Persian Blue edge and Platinum frame.

Model	Description	D"	W"	H"	F.C.	Cube	Wt.	UPS	List Price
03081	Interchange Two-Student Diamond Desk	36	60	22-34	70	7.8	78		\$ 372.00
Optional Accessories									
66013	Interchange SW (Standard Width) Tote Tray w/housing	16.8	13.5	4.48	70		10		\$ 88.00
66014	Interchange SW (Standard Width) housing only	16.8	13.5	4.48	70		8		\$ 68.00

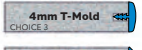
Interchange Diamond Desks Have Top and Edge Choices

- 1 1/4" Tops**
-  **CHOICE 1** – 1 1/4" top with Bumper T-Mold no letter to follow Model No.
 -  **CHOICE 2** – 1 1/4" top with 4mm T-Mold **D** to follow Model No.
- 3/4" Tops**
-  **CHOICE 3** – 3/4" top with 4mm T-Mold **C** to follow Model No.
 -  **CHOICE 4** – 3/4" top with Bullet T-Mold **V** to follow Model No.

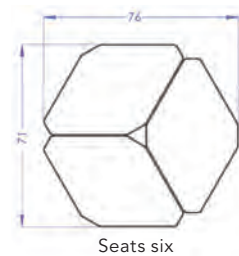
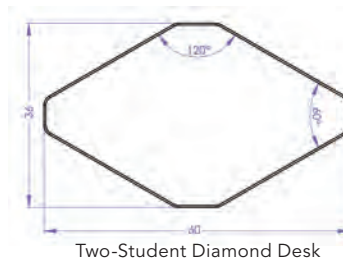



Compact and contemporary.

Cascade® totes available on select Interchange desk models. Cascade standard width (SW) tote is available on Interchange 20x27, Curve, Sequence®, Interchange 3-2-1 LS, Mini Diamond, Diamond, Two-Student Diamond and Wing desks.

Interchange 20x27 Desk, Model 04080
Shown with optional Interchange SW Tote Tray with Housing Model 66013.



Interchange Wing Desk, Model 03095
Shown with optional Interchange SW Tote Tray with Housing Model 66013.



Interchange Diamond Desk, Model 03083
Shown with optional Interchange SW Tote Tray with Housing Model 66013.

Model	Description	D"	W"	H"	F.C.	Cube	Wt.	UPS	List Price
66013	Interchange SW (Standard Width) Tote Tray w/housing	16.8	13.5	4.48	70	10			\$ 88.00
66014	Interchange SW (Standard Width) housing only	16.8	13.5	4.48	70	8			\$ 68.00

*66013 and 66014 totes are not available for 04083 Two-Student model or other rectangle shapes. See chart on page 229.

Desks Interchange®



Interchange Sequence® Desk, Model 04089
Shown in Classic Linen top with Apple edge.
Optional casters, Model 17577APL.



Interchange Single-Student Desk, Model 04080
Shown in High Rise top with Orange edge. Optional
Interchange SW Tote Tray with Housing Model 66013.
Optional Casters.



Interchange Curve Desk, Model 04090
Shown in New Age Oak top with Cerulean
edge and Platinum frame.



Interchange Two-Student Desk, Model 04083
Shown in Grey Nebula top with Black edge
and Black frame. Shown with optional casters,
Model 17576.



Two-Student Open Front Desk, Model 04502
Shown in New Age Oak Top with Black edge and Black
frame. Open front storage for two students included.



Single-Student Open Front Desk, Model 04500
Shown in Wild Cherry Top with Black edge and
Black frame.



Interchange Student Desks

These contemporary desks provide both sleek looks and solid functionality. Their large work surfaces provide ample space for projects and work of all kinds. To add storage, specify a unit with an optional built-in Bookbox, or optional Cascade Tote Tray (66013). They are available in any of 14 standard laminate colors, 20 edge colors and Black or Platinum frame.

- Interchange Desks are made with your choice of bumper edge tops.
- Edge moldings resist wear, choices available (see chart, below).
- Rugged powder coat surface on legs resists wear.
- Chrome-plated lower legs of 16-gauge steel resist scuffing.
- Sock-style glide caps add protection.
- 1" adjustable leveling glides provide stability on uneven floors.

Model	Description	D"	W"	H"	F.C.	Cube	Wt.	UPS	List Price
Rectangle Student Desks									
04080	Interchange Single-Student Desk	20	27	22-34	70	1.1	44	*	\$ 278.00
04083	Interchange Two-Student Desk*	20	48	22-34	70	2.4	74	*	\$ 333.00
04089	Interchange Sequence® Desk	23	31	22-34	70	2.4	48	*	\$ 299.00
04090	Interchange Curve Desk	21	29	22-34	70	2.4	48	*	\$ 288.00
Optional Accessories for 04080/04090/04089									
66013	Interchange SW Tote Tray w/housing	16.8	13.5	4.48	70		10		\$ 88.00
66014	Interchange SW housing only	16.8	13.5	4.48	70		8		\$ 68.00
Open Front Rectangle Student Desks									
04500	Interchange Single-Student Open Front Desk	20	27	22-32	70	1.3	37	*	\$ 340.00
04502	Interchange Two-Student Open Front Desk	24	48	22-32	70	3.0	52	*	\$ 473.00

*66013 and 66014 totes are not available for 04083 Two-Student model

Interchange Desks Have Top and Edge Choices

1 1/4" Tops



CHOICE 1 – 1 1/4" top with Bumper T-Mold
no letter to follow Model No.

D

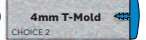

CHOICE 2 – 1 1/4" top with 4mm T-Mold
D to follow Model No.

3/4" Tops



CHOICE 3 – 3/4" top with 4mm T-Mold
C to follow Model No.

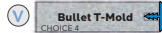

CHOICE 4 – 3/4" top with Bullet T-Mold
V to follow Model No.



Make it mobile with casters
Order Model 17576
\$ 76.00 List

Interchange Laminate Color Choice

● Asian Night	● Classic Linen	● Palisades Oak	● New Age Oak	● Grey Nebula
● Boardwalk Oak	● High Rise	● Flax Linen	● Wild Cherry	● French Pear
● Pewter Mesh	● Buka Bark	● Mission Maple	● Fusion Maple	

Leg Color Choice

● Black
● Platinum

Interchange Edge Color Choice

● Apple	● Burgundy	● Charcoal	● Forest Green	● Mocha	● Persian Blue	● Red
● Black	● Cerulean	● Chocolate	● Fuchsia	● Navy	● Platinum	● Yellow
● Blueberry	● Champagne	● Clementine	● Mint	● Orange	● Purple	

View all finish options on page 271.

Desks Interchange®

Interchange 3-2-1 Desk®

This versatile, contemporary table designed for collaborative learning provides sleek looks and solid functionality. The two-student desks can be arranged in many ways for both individual and group learning. Its work surface provides ample space for work of all kinds. Order it in any of 14 standard laminate colors, 20 edge colors and Black or Platinum frame.

- Durable desk top available in 1 1/4" or 3/4" thickness, with a high-pressure laminate surface.
- Edge moldings resist wear, choices available (see chart).
- Rugged powder coat surface on legs resists wear.
- Chrome-plated lower legs of 16-gauge steel resist scuffing.
- Sock-style glide caps add protection.
- 1" adjustable leveling glides provide stability on uneven floors.
- Adjustable table height in 1" increments

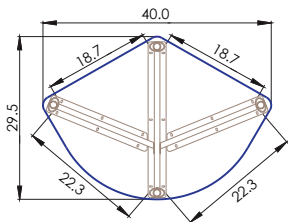

Model 03002
Bottom View

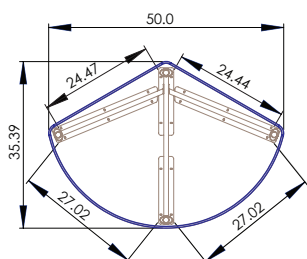

Model 03011
Bottom View

Model	Description	D"	W"	H"	F.C.	Cube	Wt.	UPS	List Price
03002*	Interchange 3-2-1 Desk	29.5	40	22-34	70	1.9	55	*	\$ 317.00
03011	Interchange 3-2-1 – LS Desk	35	50	22-34	70	2.4	67		\$ 363.00
Optional Accessories									
77159	Low Range Insert on glides	1.5	2.5	17-21			4	*	\$ 55.00
30925**	Interchange SW (Standard Width) Tote Tray w/housing	16.8	13.5		70		10		\$ 93.00

* For Pre-K through grade 2 cooperative learning classrooms with 14" h chairs and smaller.
 ** Available for 03011 LS only.

Interchange 3-2-1 Desk in New Age Oak top and Apple edge with Flavors® seating in Apple.



Combine three 3-2-1 Desks
and create a six-student group



Combine two 3-2-1 Desks for four
students to work together



Four students can work
at a single 3-2-1 Desk

Interchange 3-2-1 Desks Have Top and Edge Choices

1 1/4" Tops



CHOICE 1 – 1 1/4" top with Bumper T-Mold
no letter to follow Model No.

D

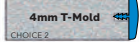

CHOICE 2 – 1 1/4" top with 4mm T-Mold
D to follow Model No.

3/4" Tops

C



CHOICE 3 – 3/4" top with 4mm T-Mold
C to follow Model No.

V



CHOICE 4 – 3/4" top with Bullet T-Mold
V to follow Model No.

Low Range Insert



Model 77159-Interchange Low Range Inserts adjust from 17-21" h on glides or 20-24" h on 3" casters. These inserts are perfect for use in early childhood environments. Pair with popular items like the 3-2-1 desk and 12" Flavors chair. \$ 55.00 List

Interchange Laminate Color Choice

● Asian Night	● Classic Linen	● Palisades Oak	● New Age Oak	● Grey Nebula
● Boardwalk Oak	● High Rise	● Flax Linen	● Wild Cherry	● French Pear
● Pewter Mesh	● Buka Bark	● Mission Maple	● Fusion Maple	

Leg Color Choice

● Black
● Platinum

Interchange Edge Color Choice

● Apple	● Burgundy	● Charcoal	● Forest Green	● Mocha	● Persian Blue	● Red
● Black	● Cerulean	● Chocolate	● Fuchsia	● Navy	● Platinum	● Yellow
● Blueberry	● Champagne	● Clementine	● Mint	● Orange	● Purple	

View all finish options on page 271.

Tables Interchange®



Model 04155
72" Table shown in Classic Linen top with Apple edge and Platinum frame. Shown with optional Flavors Mobile Chairs, Model 11855.

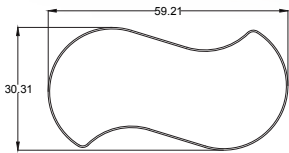

Model 04154
seats 4

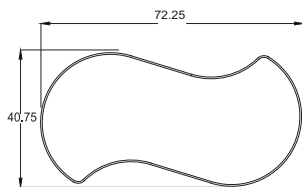

Model 04155
seats 6

Interchange Squiggle Table

The Interchange Squiggle Table has an elegant curvilinear shape that when nested together create visually stimulating collaborative pods. These collaborative tables are a fun alternative to large rectangle tables when furnishing large spaces. Available in 14 laminate color choices, 20 edge color options and a Black or Platinum frame.

Model	Description	D"	W"	H"	F.C.	Cube	Wt.	List Price
04154	60"w Interchange Squiggle Table seats 4 students	30	60	22-34	70	3.7	106	\$ 595.00
04155	72"w Interchange Squiggle Table seats 6 students	41	72	22-34	70	5.4	125	\$ 695.00



Group of 3 Squiggle Tables

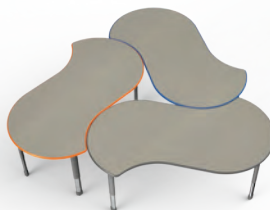

Group of 3 Squiggle Tables



Group of 4 Squiggle Tables



Model 04152
 Shown in Boardwalk Oak top with Persian Blue edge and Platinum frame Shown with optional 17576 casters.



Make it mobile with casters
 Order Model 17576
 \$ 76.00 List

Interchange Cookie Table

The versatile Cookie table is a fun shape that can be arranged in a variety of creative ways. Use a single Cookie table or join multiple together for a larger footprint collaborative space. Constructed with Interchange® durability featuring oval shaped legs that are adjustable from 22"-34" in 1 inch increments. Available in 14 laminate choices, 20 edge colors and a Black or Platinum frame.

Model	Description	D"	W"	H"	F.C.	Cube	Wt.	UPS	List Price
04152	Interchange Cookie Table	48	48	22-34	70	1.9	95		\$ 611.00

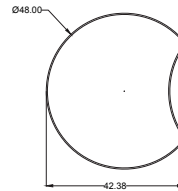

Model 04152.
 Interchange Cookie Table

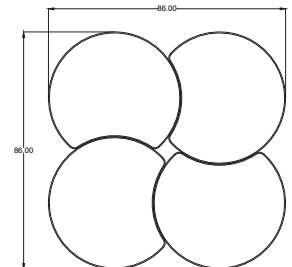

Seats eight

Tables Interchange®



Model 04157

Shown in Pewter Mesh top with Cerulean edge. Shown with 3 optional Flavors Mobile Chairs.

Interchange Crescent Table

Create a dynamic workspace for groups of up to six students with Interchange Crescent Tables. These flexible contemporary tables provide both sleek looks and solid functionality and can be ordered in any of 14 laminate colors, 20 edge colors and Black or Platinum frame.

- Edge moldings resist wear, choices available (see chart, below).
- Rugged powder coat surface on legs resists wear.
- Chrome-plated lower legs of 16-gauge steel resist scuffing.
- Sock-style glide caps add protection.
- 1" adjustable leveling glides provide stability on uneven floors.
- Add casters for ease of mobility.
- 04157 3 seating positions.
- 04156 4 seating positions.
- 5-leg table.

Model	Description	D"	W"	H"	F.C.	Cube	Wt.	UPS	List Price
04157	60"w Interchange Crescent Table seats 3 students	30	60	22-34	70	3.7	90		\$ 599.00
04156	72"w Interchange Crescent Table seats 4 students	36	72	22-34	70	6.0	155		\$ 699.00
Optional Accessory									
17578 BLA	3" Dual Wheel Caster Pack (set of 5 locking), BLACK.								\$ 95.00
17578 ___	3" Dual Wheel Caster Pack (set of 5 locking), COLOR*								\$ 120.00

*Model 17578 comes in your choice of Apple **APL**, Cerulean **CER**, Charcoal **CGR**, Orange **ORG** or Platinum **PLT**



Model 04157

Shown in Pewter Mesh tops with Cerulean edges and Platinum frame. Shown with optional Flavors Mobile Chairs.

Interchange Crescent Tables Have Top and Edge Choices

1 1/4" Tops

CHOICE 1 – 1 1/4" top with Bumper T-Mold
no letter to follow Model No.

CHOICE 2 – 1 1/4" top with 4mm T-Mold
D to follow Model No.

3/4" Tops

CHOICE 3 – 3/4" top with 4mm T-Mold
C to follow Model No.

CHOICE 4 – 3/4" top with Bullet T-Mold
V to follow Model No.

Make it mobile with casters
Order Model 17578 BLA \$ 95.00 List

Interchange Laminate Color Choice				Leg Color Choice	
● Asian Night	● Classic Linen	● Palisades Oak	● New Age Oak	● Grey Nebula	● Black
● Boardwalk Oak	● High Rise	● Flax Linen	● Wild Cherry	● French Pear	● Platinum
● Pewter Mesh	● Buka Bark	● Mission Maple	● Fusion Maple		

Interchange Edge Color Choice						
● Apple	● Burgundy	● Charcoal	● Forest Green	● Mocha	● Persian Blue	● Red
● Black	● Cerulean	● Chocolate	● Fuchsia	● Navy	● Platinum	● Yellow
● Blueberry	● Champagne	● Clementine	● Mint	● Orange	● Purple	

View all finish options on page 271.



Interchange Cre borative learning pods in seconds.



Model 04156
Shown in New Age Oak top with Black edge and Black frame. Shown with optional Flavors Mobile Chairs, Model 11855.



Model 04156
Shown in Pewter Mesh top with Black edge and Black frame. Shown with 4 optional Flavors Mobile Chairs.

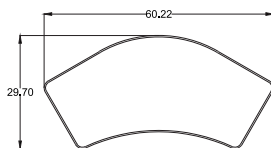

Model 04157
Interchange 60" Crescent Table
3 Seating Positions

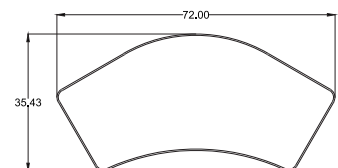

Model 04156
Interchange 72" Crescent Table
4 Seating Positions

Tables Interchange®



Model 04113

Shown in Classic Linen top with Cerulean edge and Platinum frame. Shown with optional low range leg inserts, Model 77159.

Interchange Rectangle Activity Table

This sleek, contemporary desk provides solid functionality and matches the look of Interchange student desks. Order it in any of 14 standard laminate colors, 20 edge colors and Black or Platinum frame.

- Rugged frame of 1" x 2" 14-gauge steel tube cross supports welded to 16-gauge elliptical tubes.
- Unique telescoping elliptical tube leg of 16-gauge steel adjusts height in 1" increments.
- 14-gauge cross brace along the length of the table reinforces the strength of the table legs.

**Please note: When ordering a power unit (p.104), it cannot be placed in the center of 24" deep, 30" deep and 36" deep models.*

ADD CASTERS FOR MOBILITY

- Add easy mobility to Interchange tables with casters. Model 17576, \$76 List Price, 3" Black Caster Pack (4 Locking, Threaded Caster)
- High and low range inserts available. See page 121 to order.





20"d Interchange Table, Model 04085
Shown in Grey Nebula top with Black edge and Black frame. Shown with optional casters, Model 17576.



24"d Interchange Table, Model 04102
Shown in Flax Linen top with Persian Blue edge and Platinum frame.



30"d Interchange Table, Model 04107
Shown in Buka Bark top with Black edge and Black frame.



36"d Interchange Table, Model 04112
Shown in Pewter Mesh top with Red edge and Platinum frame.



42"d Interchange Table, Model 04116
Shown in New Age Oak top with Cerulean Blue edge and Platinum frame.



48"d Interchange Table, Model 04121
Shown in Palisades Oak top with Chocolate edge and Black frame.

Tables Interchange®

Interchange Rectangle Activity Table

Model	Description		D"	W"	H"	F.C.	Cube	Wt.	UPS	List Price
20" Deep Models										
04080	Interchange Activity Table	Rectangle	20	27	22-34	70	1.1	44	*	\$ 278.00
04081	Interchange Activity Table	Rectangle	20	30	22-34	70	1.3	49	*	\$ 288.00
04082	Interchange Activity Table	Rectangle	20	36	22-34	70	1.5	58	*	\$ 298.00
04083	Interchange Activity Table	Rectangle	20	48	22-34	70	2.0	74	*	\$ 333.00
04084	Interchange Activity Table	Rectangle	20	54	22-34	70	2.2	79		\$ 356.00
04085	Interchange Activity Table	Rectangle	20	60	22-34	70	2.5	84		\$ 395.00
04086	Interchange Activity Table	Rectangle	20	72	22-34	70	3.0	98		\$ 420.00
04087	Interchange Activity Table	Rectangle	20	90	22-34	70	3.7	114		\$ 530.00
24" Deep Models										
04100	Interchange Activity Table	Rectangle	24	36	22-34	70	1.75	68	*	\$ 386.00
04101	Interchange Activity Table	Rectangle	24	48	22-34	70	2.3	82	*	\$ 432.00
04131	Interchange Activity Table	Rectangle	24	54	22-34	70	2.6	88		\$ 466.00
04102	Interchange Activity Table	Rectangle	24	60	22-34	70	2.9	92		\$ 486.00
04103	Interchange Activity Table	Rectangle	24	72	22-34	70	3.5	107		\$ 540.00
04104	Interchange Activity Table	Rectangle	24	90	22-34	70	4.4	122		\$ 596.00
30" Deep Models										
04105	Interchange Activity Table	Rectangle	30	36	22-34	70	2.2	78	*	\$ 469.00
04106	Interchange Activity Table	Rectangle	30	48	22-34	70	2.9	92		\$ 490.00
04107	Interchange Activity Table	Rectangle	30	60	22-34	70	3.7	106		\$ 543.00
04108	Interchange Activity Table	Rectangle	30	72	22-34	70	4.4	122		\$ 601.00
04109	Interchange Activity Table	Rectangle	30	90	22-34	70	5.5	139		\$ 700.00
36" Deep Models										
04111	Interchange Activity Table	Rectangle	36	48	22-34	70	3.5	104		\$ 572.00
04112	Interchange Activity Table	Rectangle	36	60	22-34	70	4.4	120		\$ 594.00
04113	Interchange Activity Table	Rectangle	36	72	22-34	70	5.3	137		\$ 642.00
04114	Interchange Activity Table	Rectangle	36	90	22-34	70	6.6	160		\$ 754.00
42" Deep Models										
04116	Interchange Activity Table	Rectangle	42	60	22-34	70	5.1	145		\$ 728.00
04117	Interchange Activity Table	Rectangle	42	72	22-34	70	6.1	165		\$ 802.00
04118	Interchange Activity Table	Rectangle	42	90	22-34	70	7.7	197		\$ 937.00
48" Deep Models										
04121	Interchange Activity Table	Rectangle	48	60	22-34	70	5.8	161		\$ 791.00
04122	Interchange Activity Table	Rectangle	48	72	22-34	70	7.0	183		\$ 877.00
04123	Interchange Activity Table	Rectangle	48	90	22-34	70	8.8	217		\$ 1,021.00

Interchange Tables Have Top and Edge Choices

1 1/4" Tops

CHOICE 1 – 1 1/4" top with Bumper T-Mold
no letter to follow Model No.

CHOICE 2 – 1 1/4" top with 4mm T-Mold
D to follow Model No.

3/4" Tops

CHOICE 3 – 3/4" top with 4mm T-Mold
C to follow Model No.

CHOICE 4 – 3/4" top with Bullet T-Mold
V to follow Model No.



Make it mobile with casters
Order Model 17576
\$ 76.00 List

Interchange Laminate Color Choice

- Asian Night
- Classic Linen
- Palisades Oak
- New Age Oak
- Grey Nebula
- Boardwalk Oak
- High Rise
- Flax Linen
- Wild Cherry
- French Pear
- Pewter Mesh
- Buka Bark
- Mission Maple
- Fusion Maple

Leg Color Choice

- Black
- Platinum

Interchange Edge Color Choice

- Apple
- Burgundy
- Charcoal
- Forest Green
- Mocha
- Persian Blue
- Red
- Black
- Cerulean
- Chocolate
- Fuchsia
- Navy
- Platinum
- Yellow
- Blueberry
- Champagne
- Clementine
- Mint
- Orange
- Purple

View all finish options on page 271.



Model 04151
Shown in Butcher Block top
and Platinum frame.

Interchange 30x60 Butcher Block Table

This sturdy, 1 3/4" thick birchwood top provides solid functionality and a contemporary design aesthetic for science, art and maker environments. The table provides ample space for projects of all kinds.

- Table height adjusts 22" to 34" in 1" increments.
- 1" adjustable leveling glides provide stability on uneven floors
- Color choices: Platinum or Black frame.

Model	Description		D"	W"	H"	F.C.	Cube	Wt.	UPS	List Price
04151	Interchange Butcher Block Table	Rectangle	30	60	22-34	70		112		\$ 1,038.00



Model 04103T
Shown in Black Trespa TopLab Plus top
and Platinum frame.



All Interchange tables come standard with structurally supported legs. Quality that you can trust will stand up to today's classroom.

Interchange Science Table Trespa® TopLab® Plus

This sturdy, contemporary science table provides sleek looks and solid functionality. Its Trespa TopLab Plus work surface is designed for maximum durability. It is resistant to a large number of aggressive chemicals (as identified by SEFA and PSI) if cleaned within 24 hours. It is engineered for moisture and scratch resistance. The table provides ample space for projects of all kinds. Color choices: Black only Trespa TopLab Plus top; Platinum or Black frame.

Model	Description		D"	W"	H"	F.C.	Cube	Wt.	UPS	List Price
24" Deep Models										
04101T	Interchange Science Table	Rectangle	24	48	22-34	70	2.7	112		\$ 1,153.00
04102T	Interchange Science Table	Rectangle	24	60	22-34	70	3.3	122		\$ 1,382.00
04103T	Interchange Science Table	Rectangle	24	72	22-34	70	4.0	137		\$ 1,610.00
04131T	Interchange Science Table	Rectangle	24	54	22-34	70	3.0	118		\$ 1,275.00
30" Deep Models										
04106T	Interchange Science Table	Rectangle	30	48	22-34	70	3.3	122		\$ 1,386.00
04107T	Interchange Science Table	Rectangle	30	60	22-34	70	4.2	136		\$ 1,656.00
04108T	Interchange Science Table	Rectangle	30	72	22-34	70	4.9	152		\$ 1,932.00

Trespa Color Choice	Frame Color Choice
● Black	● Platinum ● Black

Tables Interchange®



Interchange Half Moon
Shown in Fusion Maple top with Chocolate edge and Platinum frame with optional casters, as well as 14" and 18" Plato Chairs.

Interchange Activity Table

These contemporary tables provide both sleek looks and solid functionality. Their large work surfaces provide ample space for projects and work of all kinds. Their look matches that of Interchange student desks. Choose from 14 standard laminate colors, 20 edge colors and Black or Platinum frame.

- Rugged frame of 1"x 2" 14-gauge steel tube cross supports welded to 16-gauge elliptical tubes.
- Unique telescoping elliptical tube leg of 16-gauge steel adjusts height in 1" increments.
- 14-gauge cross brace along the length of the table reinforces the strength of the table legs.

*Please note: When ordering a power unit (p.94), it cannot be placed in the center of this table.

Model	Description		D"	W"	H"	F.C.	Cube	Wt.	UPS	List Price
04110	Interchange Activity Table	Square	36	36	22-34	70	3.0	85		\$ 496.00
04115	Interchange Activity Table	Square	42	42	22-34	70	4.0	106		\$ 623.00
04119	Interchange Activity Table	Square	48	48	22-34	70	5.0	133		\$ 672.00
04124	Interchange Activity Table	Round	42" dia.		22-34	70	2.3	88		\$ 563.00
04125	Interchange Activity Table	Round	48" dia.		22-34	70	2.6	100		\$ 611.00
04126	Interchange Activity Table	Round	60" dia.		22-34	70	3.0	150		\$ 816.00
04127	Interchange Activity Table	Trapezoid	30	60	22-34	70	2.9	92		\$ 532.00
04128	Interchange Activity Table	Half Moon	36	72	22-34	70	4.5	104		\$ 639.00
04129	Interchange Activity Table	Contour	36	72	22-34	70	4.5	124		\$ 652.00
04130	Interchange Activity Table	Kidney	48	72	22-34	70	6.0	151		\$ 869.00
04132	Interchange Activity Table	Flower		60" dia.	22-34	70	6.0	151		\$ 816.00
04158	Interchange Activity Table	Racetrack	36	72	22-34	70	4.5	122		\$ 675.00
04159	Interchange Activity Table	Peanut	36	72	22-34	70	4.5	114		\$ 675.00

Interchange Racetrack
Shown in Mission Maple top with Cerulean 4mm edge and Platinum frame. Equipped with optional 3" casters, Model 17576.



Interchange Peanut
Shown in Classic Linen top with Platinum edge and frame. Equipped with optional 3" casters, Model 17576.

Interchange Square
Shown in New Age Oak top with Clementine edge and Platinum frame.



Interchange Kidney
Shown in Grey Nebula top with Blueberry edge and Platinum frame.

Interchange Round
Shown in Grey Nebula top with Platinum edge and Platinum frame.



Interchange Contour
Shown in New Age Oak top with Mint edge and Platinum frame.

Interchange Trapezoid
Shown in Grey Nebula top, Red edge and Platinum frame.



Interchange Flower
Shown in Flax Linen top with Apple edge and Platinum frame.

Interchange Tables Have Top and Edge Choices

- 1 1/4" Tops**
- CHOICE 1** – 1 1/4" top with Bumper T-Mold no letter to follow Model No.
 - CHOICE 2** – 1 1/4" top with 4mm T-Mold **D** to follow Model No.
- 3/4" Tops**
- CHOICE 3** – 3/4" top with 4mm T-Mold **C** to follow Model No.
 - CHOICE 4** – 3/4" top with Bullet T-Mold **V** to follow Model No.



Low Range Insert

Model 77159 — Interchange Low Range Inserts adjust from 17-21" h. These inserts are perfect for use in early childhood environments. Pair with popular items like the 3-2-1 desk and 12" Flavors chair. \$ 55.00 List

Interchange Laminate Color Choice

- | | | | | |
|-----------------|-----------------|-----------------|----------------|---------------|
| ● Asian Night | ● Classic Linen | ● Palisades Oak | ● New Age Oak | ● Grey Nebula |
| ● Boardwalk Oak | ● High Rise | ● Flax Linen | ● Wild Cherry | ● French Pear |
| ● Pewter Mesh | ● Buka Bark | ● Mission Maple | ● Fusion Maple | |

Leg Color Choice

- Black
- Platinum

Interchange Edge Color Choice

- | | | | | | | |
|-------------|-------------|--------------|----------------|----------|----------------|----------|
| ● Apple | ● Burgundy | ● Charcoal | ● Forest Green | ● Mocha | ● Persian Blue | ● Red |
| ● Black | ● Cerulean | ● Chocolate | ● Fuchsia | ● Navy | ● Platinum | ● Yellow |
| ● Blueberry | ● Champagne | ● Clementine | ● Mint | ● Orange | ● Purple | |

View all finish options on page 271.

Multimedia Tables Interchange®

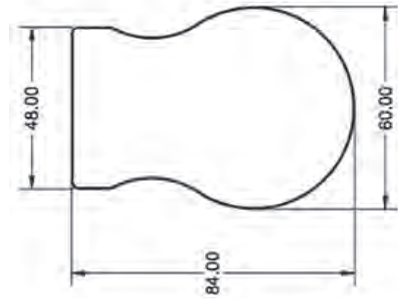

Model 04163

Shown in Pewter Mesh top with Persian Blue edge and Black frame. Shown with optional Plato Stools, optional TV Mount, Model 17354 and optional High Range Inserts, Model 77158.

Interchange Engage Multimedia Table

Features a unique curvilinear shape, providing clear sightlines for individuals viewing the monitor, participating in distance learning or engaged in group discussions or presentations. It comfortably accommodates two along each side and two at the head of the table.

Model	Description		D"	W"	H"	F.C.	Cube	Wt.	UPS	List Price
04133	Interchange Engage Multimedia Table	No Power	84	60	22-34	70	6.5	199		\$ 1,295.00
04163	Interchange Engage Multimedia Table	4 Power & 8 USB	84	60	22-34	70	6.5	199		\$ 1,995.00
04164	Interchange Engage Multimedia Table	8 Power	84	60	22-34	70	6.5	199		\$ 1,995.00
04165	Interchange Engage Multimedia Table	6 Power & 4 USB	84	60	22-34	70	6.5	199		\$ 1,995.00

Optional Accessory

17354	TV Mount	32-50" Monitors/TVs	22	14	10	70		26		\$ 495.00
-------	----------	---------------------	----	----	----	----	--	----	--	-----------

*Add "M" to table model number when ordering mount 17354. Mount will be centered.

Note: The tables on these pages are oversized and leave factory with extra packaging. Call for shipping weights.



Make your Multimedia table stand out.

Interchange High Range Inserts adjust from 30-42" h, taking Interchange Multimedia tables to standing height. These inserts are available for any Interchange table with four legs and a depth of over 30."



Model	Description		D"	W"	H"	F.C.	Cube	Wt.	UPS	List Price
77158	Interchange High Range Inserts		13	32	30-42	70		38		\$ 95.00

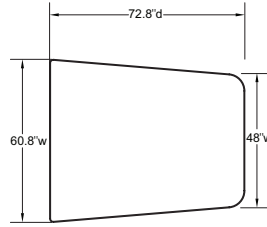

Model 04236

Shown in New Age Oak top with Platinum edge and Platinum frame. Shown with optional Flavors Chairs in Charcoal and optional TV Mount, Model 17354.

Half Boat Multimedia Table

When used alone, this sleek contemporary desk promotes interaction by allowing eye contact with all at the table. It's also great for distance learning labs when a monitor is placed at one end. Combine two for large group work. Order it in any of 14 standard laminate colors, 20 edge colors, and Black or Platinum frame. High range leg insert available.

Model	Description		D"	W"	H"	F.C.	Cube	Wt.	UPS	List Price
04235	Half Boat Multimedia Table	No Power	72.8	48-60	22-34	70	9	193		\$ 1,125.00
04236	Half Boat Multimedia Table	4 Power & 8 USB	72.8	48-60	22-34	70	9	193		\$ 1,825.00
04237	Half Boat Multimedia Table	8 Power	72.8	48-60	22-34	70	9	193		\$ 1,825.00
04238	Half Boat Multimedia Table	6 Power & 4 USB	72.8	48-60	22-34	70	9	193		\$ 1,825.00

Optional Accessory

17354	TV Mount	32-50" Monitors/TVs	22	14	10	70		26		\$ 495.00
-------	----------	---------------------	----	----	----	----	--	----	--	-----------

*Add "M" to table model number when ordering mount 17354. Mount will be centered.

Note: The tables on these pages are oversized and leave factory with extra packaging. Call for shipping weights.

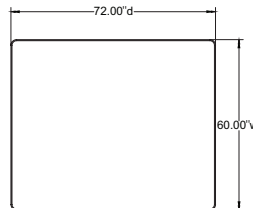

Model 04147

Shown in Asian Night top with Yellow edge and Platinum frame. Shown with Groove® Adjustable Chairs, Model 33841.

Rectangle Multimedia Table

This spacious rectangular table with sleek contemporary looks provides generous workspaces with the option of integrated power and USB, conveniently located on the work surface. Order it in any of 14 standard laminate colors, 20 edge colors and Black or Platinum frame. High range leg insert available.

Model	Description		D"	W"	H"	F.C.	Cube	Wt.	UPS	List Price
04146	Rectangle Multimedia Table	No Power	72	60	22-34	70	10	217		\$ 1,125.00
04147	Rectangle Multimedia Table	4 Power & 8 USB	72	60	22-34	70	10	217		\$ 1,825.00
04148	Rectangle Multimedia Table	8 Power	72	60	22-34	70	10	217		\$ 1,825.00
04149	Rectangle Multimedia Table	6 Power & 4 USB	72	60	22-34	70	10	217		\$ 1,825.00

Optional Accessory

17354	TV Mount	32-50" Monitors/TVs	22	14	10	70		26		\$ 495.00
-------	----------	---------------------	----	----	----	----	--	----	--	-----------

*Add "M" to table model number when ordering mount 17354. Mount will be centered.

Note: The tables on these pages are oversized and leave factory with extra packaging. Call for shipping weights.

Multimedia Tables Interchange®

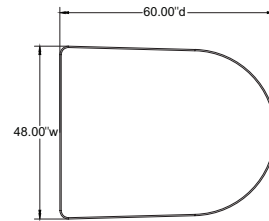

Model 04160

Shown in Mission Maple top with Platinum edge and Platinum frame. Shown with optional TV Mount, Model 17354.



**Make it mobile
with casters**
Order Model 17576
\$ 76.00 List

Medium Multimedia Table

Designed to accommodate three to four students in a compact area, this table with sleek contemporary looks can be used for small group work or distance learning. It also offers the option of integrated power and USB connectivity, conveniently located on the work surface. Order it in any of 14 standard laminate colors, 20 edge colors, and Black or Platinum frame.

Model	Description		D"	W"	H"	F.C.	Cube	Wt.	UPS	List Price
04160	Medium Multimedia Table	No Power	60	44-48	22-34	70	5.8	153		\$ 749.00
04161	Medium Multimedia Table	2 Power & 4 USB	60	44-48	22-34	70	5.8	153		\$ 1,099.00
04162	Medium Multimedia Table	4 Power	60	44-48	22-34	70	5.8	153		\$ 1,099.00
Optional Accessory										
17354	TV Mount	32-50" Monitors/TVs	22	14	10	70		26		\$ 495.00

*Add "M" to table model number when ordering mount 17354. Mount will be centered.

Large Monitor Mount



The large monitor table mount allows 32–50" monitors or TVs to be easily mounted to a table for use in conferences, displays or presentations. Great for multimedia tables. This mount bolts to the table top for a sturdy long lasting presentation aide. Mount is adjustable in height to allow a variety of monitor sizes. Accommodates VESA mounting, 100mm x 100mm to 400mm x 200mm, and 100 lb. max weight. Also comes with a keyed lock for security. Available in Platinum only.

Model	Description		D"	W"	H"	F.C.	Cube	Wt.	UPS	List Price
17354	TV Mount	32-50" Monitors/TVs	22	14	10	70		26		\$ 495.00

*Add "M" to table model number when ordering mount 17354. Mount will be centered.

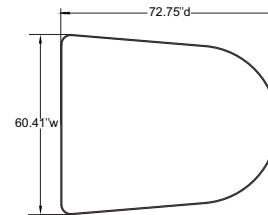

Model 04138

Shown in Pewter Mesh top with Charcoal edge and Platinum frame. Shown with TV Mount, Model 17354 and 2, Flat Surface Power Module, Model 017086 SLV 2 Power, 4 USB Ports.

Large Round End Multimedia Table

Features lines that flare, providing clear sightlines for individuals viewing the monitor, participating in distance learning or engaging in group discussions or presentations. It comfortably accommodates two along each side and two at the head of the table. High range leg insert available. See page 121 for ordering information.

Model	Description		D"	W"	H"	F.C.	Cube	Wt.	UPS	List Price
04137	Round End Multimedia Table	No Power	72.75	60.5	22-34			170		\$ 1,095.00
04138	Round End Multimedia Table	4 Power & 8 USB	72.75	60.5	22-34			170		\$ 1,795.00
04139	Round End Multimedia Table	8 Power	72.75	60.5	22-34			170		\$ 1,795.00
04140	Round End Multimedia Table	6 Power & 4 USB	72.75	60.5	22-34			170		\$ 1,795.00

Optional Accessory

17354	TV Mount	32-50" Monitors/TVs	22	14	10	70		26		\$ 495.00
-------	----------	---------------------	----	----	----	----	--	----	--	-----------

*Add "M" to table model number when ordering mount 17354. Mount will be centered.

Note: The tables on these pages are oversized and leave factory with extra packaging. Call for shipping weights.

Interchange Laminate Color Choice

● Asian Night	● Classic Linen	● Palisades Oak	● New Age Oak	● Grey Nebula
● Boardwalk Oak	● High Rise	● Flax Linen	● Wild Cherry	● French Pear
● Pewter Mesh	● Buka Bark	● Mission Maple	● Fusion Maple	

Leg Color Choice

● Black
● Platinum

Interchange Edge Color Choice

● Apple	● Burgundy	● Charcoal	● Forest Green	● Mocha	● Persian Blue	● Red
● Black	● Cerulean	● Chocolate	● Fuchsia	● Navy	● Platinum	● Yellow
● Blueberry	● Champagne	● Clementine	● Mint	● Orange	● Purple	

View all finish options on page 271.



ADD POWER

This symbol indicates you can add power to select tables.



You will find the "ADD POWER" logo throughout this catalog. It signifies which Smith System tables are compatible with our power units.

When ordering, please submit a drawing with your order to indicate the desired positioning of the power unit on the work surface. All power accessories are special order, a custom feature per table and are non-returnable. For more information call 800.328.1061.



Flat Power Module

Shown, Model 017098 SLV
1 power, 1 Twin USB port

Model	Description	D"	W"	H"	UPS	List Price
017098 SLV	1 power, 1 Twin USB port				*	\$ 260.00
017097 SLV	2 power				*	\$ 175.00



Soft Touch Dome Power Module

Shown, Model 017079
BLA 2 power, 1 Twin USB port, 1 power cord

Model	Description	D"	W"	H"	UPS	List Price
017079 BLA	2 power, 1 Twin USB port				*	\$ 245.00
017078 BLA	3 power				*	\$ 160.00



Clamp-On Power Module

4 plug power outlet with
15 ft cord

Model	Description	D"	W"	H"	UPS	List Price
17107	4 power	2.8	6.6	3.3	*	\$ 375.00



Surface Power Module

Shown, Model 017093 SLV
4 power

Model	Description	D"	W"	H"	UPS	List Price
017093 SLV	4 power	3	8	.11	*	\$ 350.00
017086 SLV	2 power, 4 USB	3	8	.11	*	\$ 350.00



Retractable Power Module

Shown, Model 017085 SLV
2 power, 2 Twin USB ports

Model	Description	D"	W"	H"	UPS	List Price
017085 SLV	2 power, 4 USB	4.43	8.25	1.34	*	\$ 495.00
017092 SLV	4 power	4.43	8.25	1.34	*	\$ 495.00



Retractable Mini Power Module

2 power

Model	Description	D"	W"	H"	UPS	List Price
017091 SLV	2 power	3.7	3.7	1.17	*	\$ 250.00



Structural framing makes this desk more solid now and in the future.



Mobile furniture needs the reinforcement of structural framing.



Reinforced to support heavy projects without bowing.

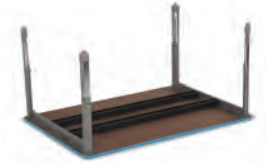

The larger the work surface, the greater the need for structural framing.



Interchange Rectangle Modesty Panel

Designed to complement tables in the Interchange and Planner lines. Order it in any of the 14 standard laminate colors, 20 edge colors.

Model	Description	D"	W"	H"	F.C.	CUBE	WT.	UPS	List Price
17201	Modesty Panel for 36" w table				70		18	*	\$ 102.00
17202	Modesty Panel for 48" w table				70		24	*	\$ 119.00
17203	Modesty Panel for 60" w table				70		30	*	\$ 135.00
17204	Modesty Panel for 72" w table				70		36		\$ 154.00
17205	Modesty Panel for 90" w table				70		44		\$ 187.00



3" Interchange Casters

Add easy mobility to Interchange Tables with casters. End Cap available in Platinum or Black. Wheels, for Black order 17576, for colors, order 17577 __ __, pack of 4 Locking Wheels.

Model	Description	D"	W"	H"	F.C.	CUBE	WT.	UPS	List Price
17576	3" Mobile Interchange Caster/Threaded (4 locking) – BLACK	3			70	0.1	5	*	\$ 76.00
Casters available in Black or Platinum Cap. Wheels are Black.									
17577 __ __	3" Mobile Interchange Caster/Threaded (4 locking) – choose from 5 COLORS	3			70	0.1	5	*	\$96.00
Casters available in Black or Platinum Cap. Wheels are your choice of Apple <i>APL</i> , Cerulean <i>CER</i> , Charcoal <i>CGR</i> , Orange <i>ORG</i> or Platinum <i>PLT</i> .									



Interchange High and Low Range Inserts

Interchange High Range Inserts adjust from 30-42" h. These inserts are perfect for Multimedia tables and any 4-leg table with a depth of over 30". Interchange Low Range Inserts adjust from 17-21" h on glides. These inserts are perfect for use in early childhood environments.

Model	Description	D"	W"	H"	F.C.	CUBE	WT.	UPS	List Price
77158	Interchange High Range Inserts	1.5	2.5	30-42	70		38	*	\$ 95.00
77159	Interchange Low Range Inserts	1.5	2.5	17-21	70		4	*	\$ 55.00

Tables Elemental®

Customizable colors
and surfaces that are
anything but basic.





5-Star

Engage Trapezoid

Sprocket

Crescent

Engage Square

Moon

Engage Rectangle

Nest & Fold

Elemental simplicity.

The Elemental line comes with a variety of fun shapes. Mix up your collaborative spaces with stars, trapezoids, squares, moons, sprockets and interlocking Yin-Yang designs.

A surface with a depth of possibilities.

The Elemental line is a great surface to be certain. But it's what's below that really counts. Customize your shape with a full selection of adjustable legs and casters for a fun and modern upgrade to your space. And as with every product from Smith System, Elemental tables are built to stand up to any classroom activity or experiment.

Let your colors fly.

Now, every facet of the Elemental line is another opportunity to demonstrate school pride or just add some variety to your classroom color scheme. Mix and match surfaces, legs and casters for a limitless mix of fun and funky possibilities.



Colored casters and matching colored leg sets

See page 141 for more information.



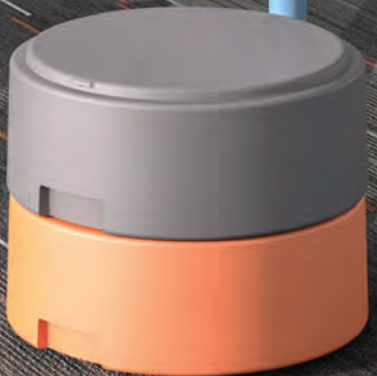

Tables Elemental®

Sprocket Table

Model ELSPRKANGAAPLEC

Shown with Asian Night top with Apple edge. Also shown with Apple Fixed Height for Caster legset (EC) paired with Apple colored 17599 APL 6-pack casters.



Engage Trapezoid Table



Model ELENTRGNBUGREC

Shown with Grey Nebula top with Orange edge. Also shown with Charcoal Fixed Height for Caster legset (EC) paired with Orange colored 17577 ORG casters.

5-Star 60" Table



Model EL5S60GNBBCEREC

Shown with Grey Nebula top with Black edge. Also shown with Cerulean Fixed Height for Caster legset (EC) paired with Cerulean colored 17578 CER 5-pack casters.

Elemental Activity Tables

It's not all just colors and shapes on the Elemental line. Leg and caster options provide even more versatility. Elemental Tables come with four leg choices: fixed height with glides (**EG**), fixed height with caster (**EC**), adjustable height (**EA**) or low-range adjustable with glides (**EL**). Adjustable height leg (**EA**) adjust from 21.5" to 35.5" with casters. Low range (**EL**) adjusts from 13.5" to 19.5" with casters.



Elemental Sprocket

Model	Description	Leg Type	Leg #	D"	W"	H"	F.C.	Cube	WT.	UPS	List Price
Sprocket Models											
ELSPRK_____EG	Sprocket Table	Fixed Height	6 Legs	59.25	67	30	70	3.7	116.5		\$ 899.00
ELSPRK_____EC*	Sprocket Table	Fixed Height for Caster	6 Legs	59.25	67	27**	70	3.6	120.5		\$ 899.00
ELSPRK_____EA	Sprocket Table	Adjustable Height	6 Legs	59.25	67	19-33	70	4.2	119.5		\$ 899.00
ELSPRK_____EL	Sprocket Table	Low Range Adjustable	6 Legs	59.25	67	11-17	70	4.2	118.5		\$ 899.00

* REMINDER: Sprocket 6-leg table requires 17599 6-pack casters, sold separately, see page 141 to order. **3" Casters make table height 30".



Elemental 5-Star

Model	Description	Leg Type	Leg #	D"	W"	H"	F.C.	Cube	WT.	UPS	List Price
5-Star Models											
EL5S48_____EG	5-Star Table (k-5)	Fixed Height	5 Legs	48"dia.	30	70	2.6	67			\$ 599.00
EL5S48_____EC*	5-Star Table (k-5)	Fixed Height for Caster	5 Legs	48"dia.	27**	70	2.6	71			\$ 599.00
EL5S48_____EA	5-Star Table (k-5)	Adjustable Height	5 Legs	48"dia.	19-33	70	2.6	70			\$ 599.00
EL5S48_____EL	5-Star Table (k-5)	Adjustable Height	5 Legs	48"dia.	11-17	70	2.6	69			\$ 599.00
EL5S60_____EG	5-Star Table	Fixed Height	5 Legs	60"dia.	30	70	3.9	95			\$ 779.00
EL5S60_____EC*	5-Star Table	Fixed Height for Caster	5 Legs	60"dia.	27**	70	3.9	99			\$ 779.00
EL5S60_____EA	5-Star Table	Adjustable Height	5 Legs	60"dia.	19-33	70	3.9	98			\$ 779.00
EL5S60_____EL	5-Star Table	Low Range Adjustable	5 Legs	60"dia.	11-17	70	3.9	97			\$ 779.00

* REMINDER: 5-star 5-leg table requires 17578 5-pack casters, sold separately, see page 141 to order. **3" Casters make table height 30".



Elemental 6-Star

Model	Description	Leg Type	Leg #	D"	W"	H"	F.C.	Cube	WT.	UPS	List Price
6-Star Models											
EL6S60_____EG	6-Star Table	Fixed Height	6 Legs	60"dia.	30	70	4.2	116.5			\$ 899.00
EL6S60_____EC*	6-Star Table	Fixed Height for Caster	6 Legs	60"dia.	27**	70	4.2	120.5			\$ 899.00
EL6S60_____EA	6-Star Table	Adjustable Height	6 Legs	60"dia.	19-33	70	4.2	119.5			\$ 899.00
EL6S60_____EL	6-Star Table	Low Range Adjustable	6 Legs	60"dia.	11-17	70	4.2	118.5			\$ 899.00

* REMINDER: 6-star 6-leg table requires 17599 6-pack casters, sold separately, see page 141 to order. **3" Casters make table height 30".



Elemental Engage Trapezoid

Model	Description	Leg Type	Leg #	D"	W"	H"	F.C.	Cube	WT.	UPS	List Price
Engage Trapezoid Models											
ELENTR_____EG	Engage Trapezoid	Fixed Height	4 Legs	30	60	30	70	2.3	70		\$ 429.00
ELENTR_____EC*	Engage Trapezoid	Fixed Height for Caster	4 Legs	30	60	27**	70	2.3	74		\$ 429.00
ELENTR_____EA	Engage Trapezoid	Adjustable Height	4 Legs	30	60	19-33	70	2.3	73		\$ 429.00
ELENTR_____EL	Engage Trapezoid	Low Range Adjustable	4 Legs	30	60	11-17	70	2.3	72		\$ 429.00

* REMINDER: Casters sold separately, see page 141 to order. **3" Casters make table height 30".

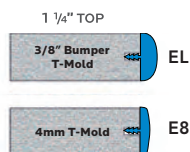

Choose MODEL

7 8 9 10 11 12 13 14 15

Pick Laminate Color Pick Edge Color Pick Leg Color

Pick Leg Style
Fixed height with Glide (EG) leg set is standard. See page 141 to order optional leg sets.



Add colored casters
See page 141 to order.

Elemental Leg Color Choice

- Apple APL
- Cerulean CER
- Charcoal CGR
- Orange ORG
- Platinum PLT

* EL leg available in Platinum only.



Tables Elemental®

Yin Yang Table



Models ELYNYGCLNSCEREC
Shown with Classic Linen top with Cerulean and Orange accent colors.



Moon Table



Model ELMOONCLNACGREC
Shown with Classic Linen top with Apple edge. Charcoal Fixed Height for Caster legset (EC) paired with Apple colored 17577 APL casters.

Elemental Yin Yang



Model	Description	Leg Type	Leg #	D"	W"	H"	F.C.	Cube	WT.	UPS	List Price
Yin Yang Models											
ELYNYG_____EG	Yin Yang Table	Fixed Height	4 Legs	64	54	30	70	4.2	90.5		\$ 669.00
ELYNYG_____EC*	Yin Yang Table	Fixed Height for Caster	4 Legs	64	54	27**	70	4.2	94.5		\$ 669.00
ELYNYG_____EA	Yin Yang Table	Adjustable Height	4 Legs	64	54	19-33	70	4.2	93.5		\$ 669.00
ELYNYG_____EL	Yin Yang Table	Low Range Adjustable	4 Legs	64	54	11-17	70	4.2	92.5		\$ 669.00
* REMINDER: Casters sold separately, see page 141 to order.							**3" Casters make table height 30"				

Elemental Moon



Model	Description	Leg Type	Leg #	D"	W"	H"	F.C.	Cube	WT.	UPS	List Price
Moon Models											
ELMOON_____EG	Moon Table	Fixed Height	4 Legs	60	41	30	70	2.7	80		\$ 619.00
ELMOON_____EC*	Moon Table	Fixed Height for Caster	4 Legs	60	41	27**	70	2.7	84		\$ 619.00
ELMOON_____EA	Moon Table	Adjustable Height	4 Legs	60	41	19-33	70	2.7	83		\$ 619.00
ELMOON_____EL	Moon Table	Low Range Adjustable	4 Legs	60	41	11-17	70	2.7	82		\$ 619.00
* REMINDER: Casters sold separately, see page 141 to order.							**3" Casters make table height 30"				

Elemental Laminate Color Choice Tops Available in 1 1/4" only.

Asian Night ANG	Pewter Mesh PEW	High Rise HRE	Palisades Oak PSO	Mission Maple MIM	Wild Cherry CHE	Grey Nebula GNB
Boardwalk Oak BWK	Classic Linen CLN	Buka Bark BBK	Flax Linen FLL	New Age Oak NEW	Fusion Maple MAP	French Pear FRP

Elemental Edge Color Choice

Apple A	Burgundy D	Charcoal R	Forest Green F	Mocha T	Persian Blue J	Red L
Black B	Cerulean S	Chocolate Q	Fuchsia G	Navy I	Platinum P	Yellow N
Blueberry C	Champagne O	Clementine E	Mint H	Orange U	Purple K	

Elemental Leg Color Choice

Apple APL	Cerulean CER	Charcoal CGR	Orange ORG	Platinum PLT	* EL leg available in Platinum only.
-----------	--------------	--------------	------------	--------------	--------------------------------------

Engage 30x72" Rectangle



Model EL37ERBBKBCGREC

Shown with Buka Bark top with Black edge. Also shown with Charcoal Fixed Height for Caster legset (EC) paired with Charcoal colored 17577CGR casters.

Engage 48" Square



Model EL48ESGNBSPLTEC

Shown with Grey Nebula top with Cerulean edge. Also shown with Platinum Fixed Height for Caster legset (EC) paired with Cerulean colored 17577CER casters.

Elemental Engage Rectangles



Model	Description	Leg Type	Leg #	D"	W"	H"	F.C.	Cube	WT.	UPS	List Price
30" Deep Rectangle 'Engage' Models											
EL36ER_____EG	Engage Rectangle	Fixed Height	4 Legs	30	60	30	70	2.3	75		\$ 429.00
EL36ER_____EC*	Engage Rectangle	Fixed Height for Caster	4 Legs	30	60	27**	70	2.3	79		\$ 429.00
EL36ER_____EA	Engage Rectangle	Adjustable Height	4 Legs	30	60	19-33	70	2.3	78		\$ 429.00
EL36ER_____EL	Engage Rectangle	Low Range Adjustable	4 Legs	30	60	11-17	70	2.3	77		\$ 429.00
EL37ER_____EG	Engage Rectangle	Fixed Height	4 Legs	30	72	30	70	2.6	94		\$ 449.00
EL37ER_____EC*	Engage Rectangle	Fixed Height for Caster	4 Legs	30	72	27**	70	2.6	98		\$ 449.00
EL37ER_____EA	Engage Rectangle	Adjustable Height	4 Legs	30	72	19-33	70	2.6	97		\$ 449.00
EL37ER_____EL	Engage Rectangle	Low Range Adjustable	4 Legs	30	72	11-17	70	2.6	96		\$ 449.00

* REMINDER: Casters sold separately, see page 141 to order. **3" Casters make table height 30"

Elemental Engage Square



Model	Description	Leg Type	Leg #	D"	W"	H"	F.C.	Cube	WT.	UPS	List Price
Square 'Engage' Models											
EL42ES_____EG	Square Table	Fixed Height	4 Legs	42	42	30	70	2.3	92		\$ 499.00
EL42ES_____EC*	Square Table	Fixed Height for Caster	4 Legs	42	42	27**	70	2.3	96		\$ 499.00
EL42ES_____EA	Square Table	Adjustable Height	4 Legs	42	42	19-33	70	2.3	95		\$ 499.00
EL42ES_____EL	Square Table	Low Range Adjustable	4 Legs	42	42	11-17	70	2.3	94		\$ 499.00
EL48ES_____EG	Square Table	Fixed Height	4 Legs	48	48	30	70	2.6	102.5		\$ 549.00
EL48ES_____EC*	Square Table	Fixed Height for Caster	4 Legs	48	48	27**	70	2.6	106.5		\$ 549.00
EL48ES_____EA	Square Table	Adjustable Height	4 Legs	48	48	19-33	70	2.6	105.5		\$ 549.00
EL48ES_____EL	Square Table	Low Range Adjustable	4 Legs	48	48	11-17	70	2.6	104.5		\$ 549.00

* REMINDER: Casters sold separately, see page 141 to order. **3" Casters make table height 30"

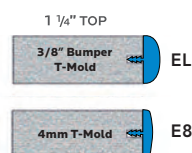

Choose MODEL

7 8 9

10

11 12 13

14 15

Pick Laminate Color

Pick Edge Color

Pick Leg Color

Pick Leg Style
Fixed height with Glide (EG) leg set is standard. See page 141 to order optional leg sets.



Add colored casters
See page 141 to order.

Tables Elemental®

60" Crescent



Model EL60CRANGAAPLEC

Shown with Asian Night top with Apple edge. Apple Fixed Height for Caster legset (EC) paired with Black 17578 casters & Groove® Mobile Chairs.

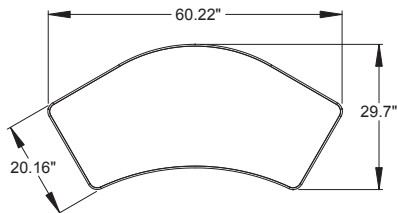

Model EL60CR
3 seating positions.

72" Crescent



Model EL72CRANGAAPLEC

Shown with Asian Night top with Apple edge. Apple Fixed Height for Caster legset (EC) paired with Black 17578 casters & Groove® Mobile Chairs.

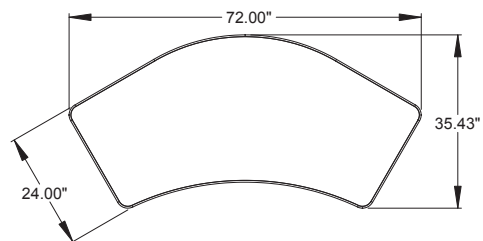

Model EL72CR
4 seating positions.



Elemental Crescents

Model	Description	Leg Type	Leg #	D"	W"	H"	F.C.	Cube	WT.	UPS	List Price
Crescent Models											
EL60CR_____EG	60" Crescent Table	Fixed Height	5 Legs	30	60	30	70	2.6	84		\$ 599.00
EL60CR_____EC*	60" Crescent Table	Fixed Height for Caster	5 Legs	30	60	27**	70	2.6	79		\$ 599.00
EL60CR_____EA	60" Crescent Table	Adjustable Height	5 Legs	30	60	19-33	70	2.6	86		\$ 599.00
EL60CR_____EL	60" Crescent Table	Low Range Adjustable	5 Legs	30	60	11-17	70	2.6	85		\$ 599.00
EL72CR_____EG	72" Crescent Table	Fixed Height	5 Legs	36	72	30	70	3.9	104		\$ 699.00
EL72CR_____EC*	72" Crescent Table	Fixed Height for Caster	5 Legs	36	72	27**	70	3.9	99		\$ 699.00
EL72CR_____EA	72" Crescent Table	Adjustable Height	5 Legs	36	72	19-33	70	3.9	106		\$ 699.00
EL72CR_____EL	72" Crescent Table	Low Range Adjustable	5 Legs	36	72	11-17	70	3.9	105		\$ 699.00

* REMINDER: Casters sold separately, see page 141 to order.

**3" Casters make table height 30"



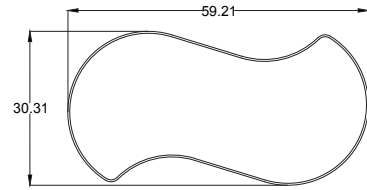

Model EL60SG
4 seating positions.

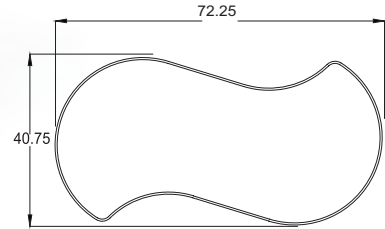

Model EL72SG
6 seating positions.

Model EL72SGBWKBPTEL

Shown with Boardwalk Oak top with Black edge.
Also shown with Platinum Low Range Adjustable leg w/ glide legset (EL).

EL – Low Range Adjustable Leg

Available in Platinum only.
11"-17" range with glides.
13.5"-19.5" with optional casters.



Elemental Squiggle

Model	Description	Leg Type	Leg #	D"	W"	H"	F.C.	Cube	WT.	UPS	List Price
Squiggle Models											
EL60SG_____EG	60" Squiggle Table	Fixed Height	4 Legs	30	60	30	70	2.6	84		\$ 595.00
EL60SG_____EC*	60" Squiggle Table	Fixed Height for Caster	4 Legs	30	60	27**	70	2.6	79		\$ 595.00
EL60SG_____EA	60" Squiggle Table	Adjustable Height	4 Legs	30	60	19-33	70	2.6	86		\$ 595.00
EL60SG_____EL	60" Squiggle Table	Low Range Adjustable	4 Legs	30	60	11-17	70	2.6	85		\$ 595.00
EL72SG_____EG	72" Squiggle Table	Fixed Height	4 Legs	41	72	30	70	3.9	104		\$ 695.00
EL72SG_____EC*	72" Squiggle Table	Fixed Height for Caster	4 Legs	41	72	27**	70	3.9	99		\$ 695.00
EL72SG_____EA	72" Squiggle Table	Adjustable Height	4 Legs	41	72	19-33	70	3.9	106		\$ 695.00
EL72SG_____EL	72" Squiggle Table	Low Range Adjustable	4 Legs	41	72	11-17	70	3.9	105		\$ 695.00
* REMINDER: Casters sold separately, see page 141 to order.										**3" Casters make table height 30"	

Elemental Laminate Color Choice Tops Available in 1 1/4" only.

- Asian Night **ANG**
- Pewter Mesh **PEW**
- High Rise **HRE**
- Palisades Oak **PSO**
- Mission Maple **MIM**
- Wild Cherry **CHE**
- Grey Nebula **GNB**
- Boardwalk Oak **BWK**
- Classic Linen **CLN**
- Buka Bark **BBK**
- Flax Linen **FLL**
- New Age Oak **NEW**
- Fusion Maple **MAP**
- French Pear **FRP**

Elemental Edge Color Choice

- Apple **A**
- Burgundy **D**
- Charcoal **R**
- Forest Green **F**
- Mocha **T**
- Persian Blue **J**
- Red **L**
- Black **B**
- Cerulean **S**
- Chocolate **Q**
- Fuchsia **G**
- Navy **I**
- Platinum **P**
- Yellow **N**
- Blueberry **C**
- Champagne **O**
- Clementine **E**
- Mint **H**
- Orange **U**
- Purple **K**

Elemental Leg Color Choice

- Apple **APL**
- Cerulean **CER**
- Charcoal **CGR**
- Orange **ORG**
- Platinum **PLT**
- * EL leg available in Platinum only.

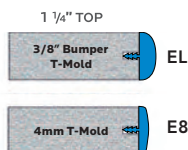

Choose MODEL

- 7
- 8
- 9

Pick Laminate Color

- 10

Pick Edge Color

- 11
- 12
- 13

Pick Leg Color

- 14
- 15

Pick Leg Style
Fixed height with Glide (EG) leg set is standard.
See page 141 to order optional leg sets.



Add colored casters
See page 141 to order.

Tables Elemental®

24x48" Rectangle Table



Models EL2448PSOUCGREG
Shown with Palisades Oak top with Orange edge and Charcoal Fixed Height legs with glides.

30x60" Rectangle Table



Model EL3060PMERAPLEC
Shown with Pewter Mesh top with Charcoal edge. Apple Fixed Height for Caster legset (EC) paired with Apple colored 17577APL casters.

Elemental Rectangle

Model	Description	Leg Type	Leg #	D"	W"	H"	F.C.	Cube	WT.	UPS	List Price
24" Deep Models											
EL2436_ _ _ _ _ EG	Rectangle Table	Fixed Height	4 Legs	24	36	30	70	1.4	46	*	\$ 269.00
EL2436_ _ _ _ _ EC*	Rectangle Table	Fixed Height for Caster	4 Legs	24	36	27**	70	1.4	50	*	\$ 269.00
EL2436_ _ _ _ _ EA	Rectangle Table	Adjustable Height	4 Legs	24	36	19-33	70	1.4	49	*	\$ 269.00
EL2436_ _ _ _ _ EL	Rectangle Table	Low Range Adjustable	4 Legs	24	36	11-17	70	1.4	48	*	\$ 269.00
EL2448_ _ _ _ _ EG	Rectangle Table	Fixed Height	4 Legs	24	48	30	70	1.6	56	*	\$ 299.00
EL2448_ _ _ _ _ EC*	Rectangle Table	Fixed Height for Caster	4 Legs	24	48	27**	70	1.6	60	*	\$ 299.00
EL2448_ _ _ _ _ EA	Rectangle Table	Adjustable Height	4 Legs	24	48	19-33	70	1.6	59	*	\$ 299.00
EL2448_ _ _ _ _ EL	Rectangle Table	Low Range Adjustable	4 Legs	24	48	11-17	70	1.6	58	*	\$ 299.00
EL2460_ _ _ _ _ EG	Rectangle Table	Fixed Height	4 Legs	24	60	30	70	1.9	66	*	\$ 379.00
EL2460_ _ _ _ _ EC*	Rectangle Table	Fixed Height for Caster	4 Legs	24	60	27**	70	1.9	70	*	\$ 379.00
EL2460_ _ _ _ _ EA	Rectangle Table	Adjustable Height	4 Legs	24	60	19-33	70	1.9	69	*	\$ 379.00
EL2460_ _ _ _ _ EL	Rectangle Table	Low Range Adjustable	4 Legs	24	60	11-17	70	1.9	68	*	\$ 379.00
EL2472_ _ _ _ _ EG	Rectangle Table	Fixed Height	4 Legs	24	72	30	70	2.2	76		\$ 409.00
EL2472_ _ _ _ _ EC*	Rectangle Table	Fixed Height for Caster	4 Legs	24	72	27**	70	2.2	80		\$ 409.00
EL2472_ _ _ _ _ EA	Rectangle Table	Adjustable Height	4 Legs	24	72	19-33	70	2.2	79		\$ 409.00
EL2472_ _ _ _ _ EL	Rectangle Table	Low Range Adjustable	4 Legs	24	72	11-17	70	2.2	78		\$ 409.00
30" Deep Models											
EL3048_ _ _ _ _ EG	Rectangle Table	Fixed Height	4 Legs	30	48	30	70	1.9	66	*	\$ 329.00
EL3048_ _ _ _ _ EC*	Rectangle Table	Fixed Height for Caster	4 Legs	30	48	27**	70	1.9	70	*	\$ 329.00
EL3048_ _ _ _ _ EA	Rectangle Table	Adjustable Height	4 Legs	30	48	19-33	70	1.9	69	*	\$ 329.00
EL3048_ _ _ _ _ EL	Rectangle Table	Low Range Adjustable	4 Legs	30	48	11-17	70	1.9	68	*	\$ 329.00
EL3060_ _ _ _ _ EG	Rectangle Table	Fixed Height	4 Legs	30	60	30	70	2.3	79		\$ 429.00
EL3060_ _ _ _ _ EC*	Rectangle Table	Fixed Height for Caster	4 Legs	30	60	27**	70	2.3	83		\$ 429.00
EL3060_ _ _ _ _ EA	Rectangle Table	Adjustable Height	4 Legs	30	60	19-33	70	2.3	82		\$ 429.00
EL3060_ _ _ _ _ EL	Rectangle Table	Low Range Adjustable	4 Legs	30	60	11-17	70	2.3	81		\$ 429.00
EL3072_ _ _ _ _ EG	Rectangle Table	Fixed Height	4 Legs	30	72	30	70	2.6	98		\$ 449.00
EL3072_ _ _ _ _ EC*	Rectangle Table	Fixed Height for Caster	4 Legs	30	72	27**	70	2.6	102		\$ 449.00
EL3072_ _ _ _ _ EA	Rectangle Table	Adjustable Height	4 Legs	30	72	19-33	70	2.6	101		\$ 449.00
EL3072_ _ _ _ _ EL	Rectangle Table	Low Range Adjustable	4 Legs	30	72	11-17	70	2.6	100		\$ 449.00

* REMINDER: Casters sold separately, see page 141 to order.

**3" Casters make table height 30"

42" Square Table



Model EL4242HRESCEREC

Shown with High Rise top with Cerulean edge. Also shown with Cerulean Fixed Height for Caster legset (EC) paired with Cerulean colored 17577CER casters.

30x60" Trapezoid Table



Model EL60TRCLNSCGREC

Shown with Classic Linen top with Cerulean edge. Also shown with Platinum Fixed Height for Caster legset (EC) paired with Charcoal colored 17577CGR casters.

Elemental Square



Model	Description	Leg Type	Leg #	D"	W"	H"	F.C.	Cube	WT.	UPS	List Price
Square Models											
EL3636_____EG	Square Table	Fixed Height	4 Legs	36	36	30	70	1.7	61	*	\$ 309.00
EL3636_____EC*	Square Table	Fixed Height for Caster	4 Legs	36	36	27**	70	1.7	65	*	\$ 309.00
EL3636_____EA	Square Table	Adjustable Height	4 Legs	36	36	19-33	70	1.7	64	*	\$ 309.00
EL3636_____EL	Square Table	Low Range Adjustable	4 Legs	36	36	11-17	70	1.7	63	*	\$ 309.00
EL4242_____EG	Square Table	Fixed Height	4 Legs	42	42	30	70	2.3	78.5		\$ 429.00
EL4242_____EC*	Square Table	Fixed Height for Caster	4 Legs	42	42	27**	70	2.3	82.5		\$ 429.00
EL4242_____EA	Square Table	Adjustable Height	4 Legs	42	42	19-33	70	2.3	81.5		\$ 429.00
EL4242_____EL	Square Table	Low Range Adjustable	4 Legs	42	42	11-17	70	2.3	80.5		\$ 429.00
EL4848_____EG	Square Table	Fixed Height	4 Legs	48	48	30	70	2.6	96		\$ 449.00
EL4848_____EC*	Square Table	Fixed Height for Caster	4 Legs	48	48	27**	70	2.6	100		\$ 449.00
EL4848_____EA	Square Table	Adjustable Height	4 Legs	48	48	19-33	70	2.6	99		\$ 449.00
EL4848_____EL	Square Table	Low Range Adjustable	4 Legs	48	48	11-17	70	2.6	98		\$ 449.00

* REMINDER: Casters sold separately, see page 141 to order.

**3" Casters make table height 30"

Elemental Trapezoid



Model	Description	Leg Type	Leg #	D"	W"	H"	F.C.	Cube	WT.	UPS	List Price
Trapezoid Models											
EL60TR_____EG	Trapezoid Table	Fixed Height	4 Legs	30	60	30	70	2.3	61		\$ 429.00
EL60TR_____EC*	Trapezoid Table	Fixed Height for Caster	4 Legs	30	60	27**	70	2.3	65		\$ 429.00
EL60TR_____EA	Trapezoid Table	Adjustable Height	4 Legs	30	60	19-33	70	2.3	64		\$ 429.00
EL60TR_____EL	Trapezoid Table	Adjustable Height	4 Legs	30	60	11-17	70	2.3	63		\$ 429.00

* REMINDER: Casters sold separately, see page 141 to order.

**3" Casters make table height 30"

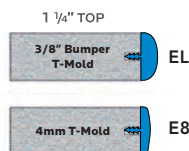

Choose MODEL

7 8 9

10

11 12 13

14 15

Pick Laminate Color

Pick Edge Color

Pick Leg Color

Pick Leg Style
Fixed height with Glide (EG) leg set is standard. See page 141 to order optional leg sets.



Add colored casters

See page 141 to order.

Tables Elemental®

Elemental Half Moon Table



Model ELHAMOBWKCEREC
Shown with Boardwalk Oak top with Charcoal edge. Cerulean Fixed Height for Caster legset (EC) paired with Cerulean colored 17577CER casters.

Elemental Clover Table



Model EL48CLBWKACGREG
Shown with Boardwalk Oak top with Apple edge. Charcoal Fixed Height for Caster legset (EC) paired with Charcoal colored 17577CGR casters.

Elemental Half Moon



Model	Description	Leg Type	Leg #	D"	W"	H"	F.C.	Cube	WT.	UPS	List Price
Half Moon Models											
ELHAMO_____EG	Half Moon Table	Fixed Height	4 Legs	36	72	30	70	3.0	94		\$ 469.00
ELHAMO_____EC*	Half Moon Table	Fixed Height for Caster	4 Legs	36	72	27**	70	3.0	98		\$ 469.00
ELHAMO_____EA	Half Moon Table	Adjustable Height	4 Legs	36	72	19-33	70	3.7	97		\$ 469.00
ELHAMO_____EL	Half Moon Table	Low Range Adjustable	4 Legs	36	72	11-17	70	3.7	96		\$ 469.00
* REMINDER: Casters sold separately, see page 141 to order.						**3" Casters make table height 30"					

Elemental Clover



Model	Description	Leg Type	Leg #	D"	W"	H"	F.C.	Cube	WT.	UPS	List Price
Clover Models											
EL48CL_____EG	Clover Table	Fixed Height	4 Legs	48"dia.	30	70	2.6	74			\$ 449.00
EL48CL_____EC*	Clover Table	Fixed Height for Caster	4 Legs	48"dia.	27**	70	2.6	78			\$ 449.00
EL48CL_____EA	Clover Table	Adjustable Height	4 Legs	48"dia.	19-33	70	2.6	77			\$ 449.00
EL48CL_____EL	Clover Table	Low Range Adjustable	4 Legs	48"dia.	11-17	70	2.6	76			\$ 449.00
* REMINDER: Casters sold separately, see page 141 to order.						**3" Casters make table height 30"					

Elemental Laminate Color Choice Tops Available in 1 1/4" only.

- Asian Night **ANG**
- Pewter Mesh **PEW**
- High Rise **HRE**
- Palisades Oak **PSO**
- Mission Maple **MIM**
- Wild Cherry **CHE**
- Grey Nebula **GNB**
- Boardwalk Oak **BWK**
- Classic Linen **CLN**
- Buka Bark **BBK**
- Flax Linen **FLL**
- New Age Oak **NEW**
- Fusion Maple **MAP**
- French Pear **FRP**

Elemental Edge Color Choice

- Apple **A**
- Burgundy **D**
- Charcoal **R**
- Forest Green **F**
- Mocha **T**
- Persian Blue **J**
- Red **L**
- Black **B**
- Cerulean **S**
- Chocolate **Q**
- Fuchsia **G**
- Navy **I**
- Platinum **P**
- Yellow **N**
- Blueberry **C**
- Champagne **O**
- Clementine **E**
- Mint **H**
- Orange **U**
- Purple **K**

Elemental Leg Color Choice

- Apple **APL**
 - Cerulean **CER**
 - Charcoal **CGR**
 - Orange **ORG**
 - Platinum **PLT**
- * EL leg available in Platinum only.

Elemental Kidney Table



Model EL4872CLNSCEREC

Shown with Classic Linen top with Cerulean edge. Also shown with Cerulean Fixed Height for Caster legset (EC) paired with Cerulean colored 17577CER casters.

Elemental 42" Round Table



Model EL42RDMIMRCGREC

Shown with Mission Maple top with Charcoal edge. Also shown with Charcoal Fixed Height for Caster legset (EC) paired with Charcoal colored 17577CGR casters.

Elemental Kidney



Model	Description	Leg Type	Leg #	D"	W"	H"	F.C.	Cube	WT.	UPS	List Price
Kidney Models											
EL4872_____EG	Kidney Table	Fixed Height	4 Legs	48	72	30	70	3.8	120		\$ 549.00
EL4872_____EC*	Kidney Table	Fixed Height for Caster	4 Legs	48	72	27**	70	3.8	124		\$ 549.00
EL4872_____EA	Kidney Table	Adjustable Height	4 Legs	48	72	19-33	70	3.8	123		\$ 549.00
EL4872_____EL	Kidney Table	Low Range Adjustable	4 Legs	48	72	11-17	70	3.8	122		\$ 549.00

* REMINDER: Casters sold separately, see page 141 to order.

**3" Casters make table height 30"

Elemental Round



Model	Description	Leg Type	Leg #	D"	W"	H"	F.C.	Cube	WT.	UPS	List Price
Round Models											
EL42RD_____EG	Round Table	Fixed Height	4 Legs	42"dia.		30	70	2.3	64		\$ 399.00
EL42RD_____EC*	Round Table	Fixed Height for Caster	4 Legs	42"dia.		27**	70	2.3	68		\$ 399.00
EL42RD_____EA	Round Table	Adjustable Height	4 Legs	42"dia.		19-33	70	2.3	67		\$ 399.00
EL42RD_____EL	Round Table	Adjustable Height	4 Legs	42"dia.		11-17	70	2.3	66		\$ 399.00
EL48RD_____EG	Round Table	Fixed Height	4 Legs	48"dia.		30	70	2.6	79		\$ 409.00
EL48RD_____EC*	Round Table	Fixed Height for Caster	4 Legs	48"dia.		27**	70	2.6	83		\$ 409.00
EL48RD_____EA	Round Table	Adjustable Height	4 Legs	48"dia.		19-33	70	2.6	82		\$ 409.00
EL48RD_____EL	Round Table	Low Range Adjustable	4 Legs	48"dia.		11-17	70	2.6	81		\$ 409.00

* REMINDER: Casters sold separately, see page 141 to order.

**3" Casters make table height 30"

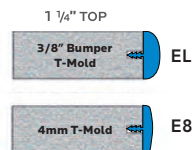

Choose
MODEL

7 8 9

10

11 12 13

14 15

Pick
Laminate
Color

Pick
Edge
Color

Pick Leg
Color

Pick Leg Style
Fixed height with Glide
(EG) leg set is standard.
See page 141 to order
optional leg sets.



Add colored casters

See page 141 to order.





Tables Elemental®

Center leg design allows students to sit on both sides.



Model NL2460FRPRCGREJ

Shown with French Pair top with Charcoal edge, Charcoal adjustable leg set and matching Charcoal casters. Paired with Theorem Arm Chairs in Persian Blue, Model 44815.

Elemental Laminate Color Choice Tops Available in 1 1/4" only.

● Asian Night ANG	● Pewter Mesh PEW	● High Rise HRE	● Palisades Oak PSO	● Mission Maple MIM	● Wild Cherry CHE	● Grey Nebula GNB
● Boardwalk Oak BWK	● Classic Linen CLN	● Buka Bark BBK	● Flax Linen FLL	● New Age Oak NEW	● Fusion Maple MAP	● French Pear FRP

Elemental Edge Color Choice

● Apple A	● Burgundy D	● Charcoal R	● Forest Green F	● Mocha T	● Persian Blue J	● Red L
● Black B	● Cerulean S	● Chocolate Q	● Fuchsia G	● Navy I	● Platinum P	● Yellow N
● Blueberry C	● Champagne O	● Clementine E	● Mint H	● Orange U	● Purple K	

Elemental Leg Color Choice

● Apple APL	● Cerulean CER	● Charcoal CGR	● Orange ORG	● Platinum PLT
--------------------	-----------------------	-----------------------	---------------------	-----------------------

Fixed Height Table



Adjustable Height Table

Adjusts 29–40" h



Elemental Nest & Fold

Elemental Nest & Fold Tables provide a stable, spacious work surface and contemporary appearance. They offer added utility when not in use through their easy mobility and compact storage. Because they're part of an integrated line of tables and desking, they allow a consistent design scheme throughout the building or facility. Choose from 14 standard laminate tops and 20 standard edge colors. Frames available in platinum, charcoal, apple, cerulean and orange.

Model	Description	Leg Type	D"	W"	H"	F.C.	Cube	WT.	UPS	List Price
Fixed Height										
NL2448_____EF	24x48 Nest & Fold	Fixed Height w/casters	24	48	30	70	2.3	82		\$ 699.00
NL2460_____EF	24x60 Nest & Fold	Fixed-Height w/casters	24	60	30	70	2.3	95		\$ 799.00
NL2472_____EF	24x72 Nest & Fold	Fixed-Height w/casters	24	72	30	70	2.3	111		\$ 899.00
NL3048_____EF	30x48 Nest & Fold	Fixed-Height w/casters	30	48	30	70	2.6	93		\$ 749.00
NL3060_____EF	30x60 Nest & Fold	Fixed-Height w/casters	30	60	30	70	2.6	109		\$ 849.00
NL3072_____EF	30x72 Nest & Fold	Fixed-Height w/casters	30	72	30	70	2.6	126		\$ 949.00
Adjustable Height										
NL2448_____EJ	24x48 Nest & Fold	Adjustable Height w/casters	24	48	29-40	70	2.3	84		\$ 749.00
NL2460_____EJ	24x60 Nest & Fold	Adjustable Height w/casters	24	60	29-40	70	2.3	97		\$ 849.00
NL2472_____EJ	24x72 Nest & Fold	Adjustable Height w/casters	24	72	29-40	70	2.3	113		\$ 949.00
NL3048_____EJ	30x48 Nest & Fold	Adjustable Height w/casters	30	48	29-40	70	2.6	95		\$ 799.00
NL3060_____EJ	30x60 Nest & Fold	Adjustable Height w/casters	30	60	29-40	70	2.6	111		\$ 899.00
NL3072_____EJ	30x72 Nest & Fold	Adjustable Height w/casters	30	72	29-40	70	2.6	128		\$ 999.00

* REMINDER: Casters are included with Elemental Nest & Fold.

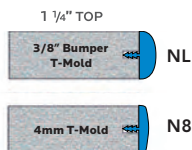

Choose MODEL

7 8 9

10

11 12 13

14 15

Pick Laminata Color

Pick Edge Color

Pick Leg Color

Pick Leg Style
Fixed height caster (EF)
Adjustable caster (EJ)



Casters standard on Nest & Fold.

Color matched to leg.

Customize your Elemental Part Number.

Here's our simple system for ordering Elemental tables exactly the way you want them.

1. Decide what features and options you want.
2. Find them in the columns below.
3. Write them down in sequence.

Or just pick a pre-configured model and all you have to do is specify your color choice.



Remember! Casters sold separately due to color choices.

1 2

Type

1 1/4" Tops

EL = Elemental Table 3/8" Bumper

E8 = Elemental Table 4mm T-mold

NL = Elemental Nest & Fold 3/8" Bumper^

N8 = Elemental Nest & Fold 4mm T-mold^

Elemental Table Tops and Edge

1 1/4" Tops



3/8" Bumper T-Mold

1 1/4" Tops^



4mm T-Mold



3 4 5 6

Table Top Size

New Elemental Shapes

SPRK = Sprocket**

5548 = 48" dia. 5-Star (K-5)*

5560 = 60" dia. 5-Star*

6560 = 67" dia. 6-Star**

ENTR = Engage Trapezoid

MOON = Moon

YNYG = Yin Yang

48ES = 48" Engage Square

42ES = 42" Engage Square

36ER = 30"x60" Engage Rectangle

37ER = 30"x72" Engage Rectangle

25ER = 24"x54" Engage Rectangle

24ER = 24"x48" Engage Rectangle

60SG = 60" Squiggle

72SG = 72" Squiggle

Classic Shapes

2436 = 24"x36" Rectangle

2448 = 24"x48" Rectangle^

2460 = 24"x60" Rectangle^

2472 = 24"x72" Rectangle^

3048 = 30"x48" Rectangle^

3060 = 30"x60" Rectangle^

3072 = 30"x72" Rectangle^

3636 = 36"x36" Square

4242 = 42"x42" Square

4848 = 48"x48" Square

60TR = 30"x60" Trapezoid

60CR = 30"x60" Crescent*

72CR = 36"x72" Crescent*

42RD = 42" Round

48RD = 48" Round

4872 = 48"x72" Kidney

HAMO = 36"x72" Half Moon

48CL = 48" Clover

HOSH = 57"x66" Horseshoe**

* 5-legs

** 6-legs

^ Nest & Fold Sizes

4, 5 and 6 leg tables, order casters to match leg number.

7 8 9

Laminate Color

See Laminate Color Chart

Choose 3 Letters

10

Edge Color

See Edge Color Chart

Choose 1 Letter

11 12 13

Leg Color

PLT = Platinum

CGR = Charcoal

CER = Cerulean

ORG = Orange

APL = Apple

Choose 3 Letters

14 15

Activity Leg Type

EG = Fixed Height Leg with Glide (30" h with top)*

EC = Fixed Height Leg for Caster (30" h with 3" Caster and top)**

EA = Adjustable Height Leg (19"-33" with glides (14" throw)

EL = Low Range Adjustable Leg (11"-17" with glides (6" throw)

**Casters sold separately due to color choices.

See opposite page for details. Add caster price to purchase.

Nest & Fold Leg Type

EF = Fixed Height Leg with casters included. 30" h

EJ = Adjustable Height Leg with casters included. 29-40" h

**Casters included with Nest & Fold tables only!

Elemental Laminate Color Choice

- Asian Night ANG
- Pewter Mesh PEW
- High Rise HRE
- Palisades Oak PSO
- Mission Maple MIM
- Wild Cherry CHE
- Grey Nebula GNB
- Boardwalk Oak BWK
- Classic Linen CLN
- Buka Bark BBK
- Flax Linen FLL
- New Age Oak NEW
- Fusion Maple MAP
- French Pear FRP

Elemental Edge Color Choice

- Apple A
- Burgundy D
- Charcoal R
- Forest Green F
- Mocha T
- Persian Blue J
- Red L
- Black B
- Cerulean S
- Chocolate Q
- Fuchsia G
- Navy I
- Platinum P
- Yellow N
- Blueberry C
- Champagne O
- Clementine E
- Mint H
- Orange U
- Purple K

Elemental Leg Color Choice

- Apple APL
- Cerulean CER
- Charcoal CGR
- Orange ORG
- Platinum PLT

Elemental Leg Options

Elemental Tables have four leg choices;

- (EG)** Fixed height leg with glide, 30" with glides.
- (EC)** Fixed height leg for caster, 30" with casters.
- (EA)** Adjustable height leg 19"-33" with glides.
- (EL)** Low range adjustable leg 11"-17" with glides.

EG, EC, EA Legs available in Platinum (**PLT**), Charcoal (**CGR**), Orange (**ORG**), Cerulean (**CER**) and Apple (**APL**) and are 2" in diameter.

EL Low range legs available in Platinum (**PLT**) only.



Elemental 3" Colored Casters

Add easy mobility to Elemental Tables. Specify with fixed height leg for caster (**EC**) adjustable height leg (**EA**) or low range adjustable leg (**EL**). Adjustable height leg (**EA**) adjusts from 21.5" to 35.5" with casters. Low range (**EL**) adjusts from 13.5" to 19.5" with casters. Casters available in 6 colors:



Model	Description	Caster Qty	D"	F.C.	Cube	WT.	UPS	List Price
4 Quantity Caster Packs for use on 4-leg Tables								
17576	3" Black Elemental Caster	4 Locking	3	70	0.1	5	*	\$ 76.00
17577 PLT	3" Platinum Elemental Caster	4 Locking	3	70	0.1	5	*	\$ 96.00
17577 CGR	3" Charcoal Elemental Caster	4 Locking	3	70	0.1	5	*	\$ 96.00
17577 ORG	3" Orange Elemental Caster	4 Locking	3	70	0.1	5	*	\$ 96.00
17577 CER	3" Cerulean Elemental Caster	4 Locking	3	70	0.1	5	*	\$ 96.00
17577 APL	3" Apple Elemental Caster	4 Locking	3	70	0.1	5	*	\$ 96.00
5 Quantity Caster Packs for use on 5-Star Tables								
17578 BLA	3" Black Elemental Caster	5 Locking	3	70	0.1	6.25	*	\$ 95.00
17578 PLT	3" Platinum Elemental Caster	5 Locking	3	70	0.1	6.25	*	\$ 120.00
17578 CGR	3" Charcoal Elemental Caster	5 Locking	3	70	0.1	6.25	*	\$ 120.00
17578 ORG	3" Orange Elemental Caster	5 Locking	3	70	0.1	6.25	*	\$ 120.00
17578 CER	3" Cerulean Elemental Caster	5 Locking	3	70	0.1	6.25	*	\$ 120.00
17578 APL	3" Apple Elemental Caster	5 Locking	3	70	0.1	6.25	*	\$ 120.00
6 Quantity Caster Packs for use on 6-Star and Sprocket Tables								
17599 BLA	3" Black Elemental Caster	6 Locking	3	70	0.1	7.50	*	\$ 114.00
17599 PLT	3" Platinum Elemental Caster	6 Locking	3	70	0.1	7.50	*	\$ 144.00
17599 CGR	3" Charcoal Elemental Caster	6 Locking	3	70	0.1	7.50	*	\$ 144.00
17599 ORG	3" Orange Elemental Caster	6 Locking	3	70	0.1	7.50	*	\$ 144.00
17599 CER	3" Cerulean Elemental Caster	6 Locking	3	70	0.1	7.50	*	\$ 144.00
17599 APL	3" Apple Elemental Caster	6 Locking	3	70	0.1	7.50	*	\$ 144.00

*Casters sold separately due to color choices. when purchasing legs with casters, casters must be specified as additional line item.

Tables & Desks UXL®

A line with a contemporary aesthetic, offering great breadth and versatility.





Sit + Stand



Sit + Stand Lectern



Nest & Fold Table

For a consistent design scheme.

This broad, highly customizable line can be used throughout the school. This allows you to maintain consistent colors, finishes and leg shapes, bringing unity to the school's décor.

For collaborative learning or traditional classrooms.

UXL Sit + Stand Desks provide functionality and choice of height to collaborative learning classrooms.

Healthy construction.

UL GREENGUARD Gold Certified.

Table options.

UXL Tables can be configured in countless ways, allowing them to perform admirably as activity tables, student desks, media stations or teacher/administration desks.

Nest & Fold tables.

Mobile tables with tilting work surfaces that allow them to be stored compactly.

Dependability.

Lifetime warranty on the frame and legs, 12-year warranty on table and desktops.

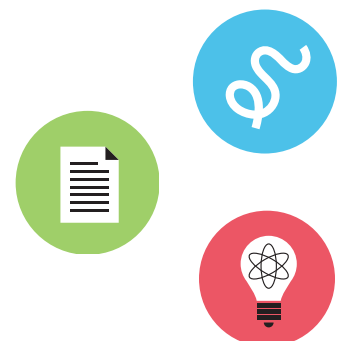

How to Be Strategic w/ Guest Blogging and Content Licensing Without Incurring Duplicate Content Issues

Your Site's Audience

e.g. lightboarding.com

Popular Niche Site's Audience

e.g. SmashingMagazine.com
DesignersHubspot.com
[Web Designer Depot.com](http://WebDesigner Depot.com)
PenelopeTrunk.com

UGC Platform's Potential Audience

e.g. YouTube.com
Medium.com
AmericanExpress.com / [Major Media Site's Audience](http://openforum</p>
</div>
<div data-bbox=)

e.g. Inc.com
Forbes.com
Entrepreneur.com

Process

Can you rank for it on your own site? Do you have a large enough audience to earn the necessary signals?

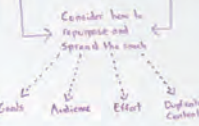
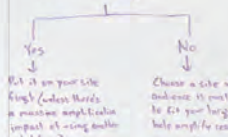

Questions to Consider

- 1. If ranking was the primary goal, are you best the big, in-depth version on your site than link back from the other guest outlet?
- 2. Should you use the highest title in your version of the one you intend/post?
- 3. Can you get a backlink on the linked version?
- 4. Is it better to expand energy creating more content for your site OR amplifying the reach of your best/s single piece of content on other sites?

UX/Trends

- 1. There is still a significant gap
- 2. UX design and time spent on site is still a trend
- 3. The search engine is still a trend

How to Make the Demand Distribution Curve of Your Site and the It to Intere - Improve Your SEO and Content Strategy



- Content that has "long tail" of content
- Clearly trackable, e.g. backlinks
- Make demand concentrated in the head, e.g. SEO
- Applicable to head demand of a head of demand phase, e.g. Google Core Update

UX History
 2/23/11 - Part #271
 5/19/15 - S
 Quality-First

Content Quality and SEO

↳ Meas Shoes



What do they want?

- Sneakers?
- Sandals?
- Draw Shoes?
- ...
- A Way to Buy?
- Privacy Policy?
- Phone Number?

Search Qual
links about
(1998)
Just
multiple!



Desks UXL® Sit + Stand



Put students in control with the desk that can adapt to any learning situation.

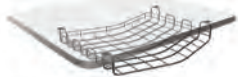

Model 76518
Technology basket low profile storage for laptops, tablets or books/papers.



Model 76517
Screen shown in downward modesty position.

UXL Sit + Stand Student Desk

The UXL Sit + Stand student desk is a welcome addition to any collaborative environment. Specify 4-6 to create an engaging learning zone, or outfit the entire classroom for the ultimate flexible learning environment. Featuring a unique adjustable column that floats from 26 inches to 42 inches with the press of a lever, this student desk truly adapts to any learning situation. At its lowest height students can choose to use a standard 16" or 18" height chair.

Model 26548V, UXL Sit + Stand Student Desk shown in Classic Linen top with Forest Green edge. Shown with optional 76518 Sit Stand Technology Basket.

Model	Description	D"	W"	H"	F.C.	Cube	Wt.	UPS	List Price
26547V	UXL Sit + Stand Student Desk, Small Rectangle	20	23.5	26-41.5	85	40	40	*	\$ 849.00
26548V	UXL Sit + Stand Student Desk, Collaborative	21	30	26-41.5	85	40	40	*	\$ 849.00
26549V	UXL Sit + Stand Student Desk, Large Rectangle	20	27	26-41.5	85	40	40	*	\$ 849.00
Optional Accessory									
76518	Sit + Stand Technology Basket	10	14	3	70	3	3	*	\$ 59.00
76517	Modesty Panel/Privacy Screen*	1.5	24	13.75		5	5	*	\$ 99.00

* Modesty Panel/Privacy Screen not compatible with 20x27 top.

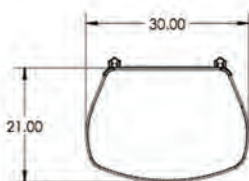

Model 26548V,
Collaborative top

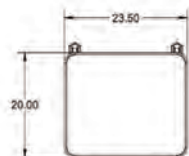

Model 26547V,
Small Rectangle top

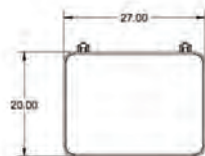

Model 26549V,
20x27 top

Sit + Stand Has Top and Edge Choices (V is standard)

3/4" Tops

- (V)** Bullet T-Mold → 3/4" top with Bullet T-Mold V to follow Model No.
- (C)** 4mm T-Mold → 3/4" top with 4mm T-Mold C to follow Model No.

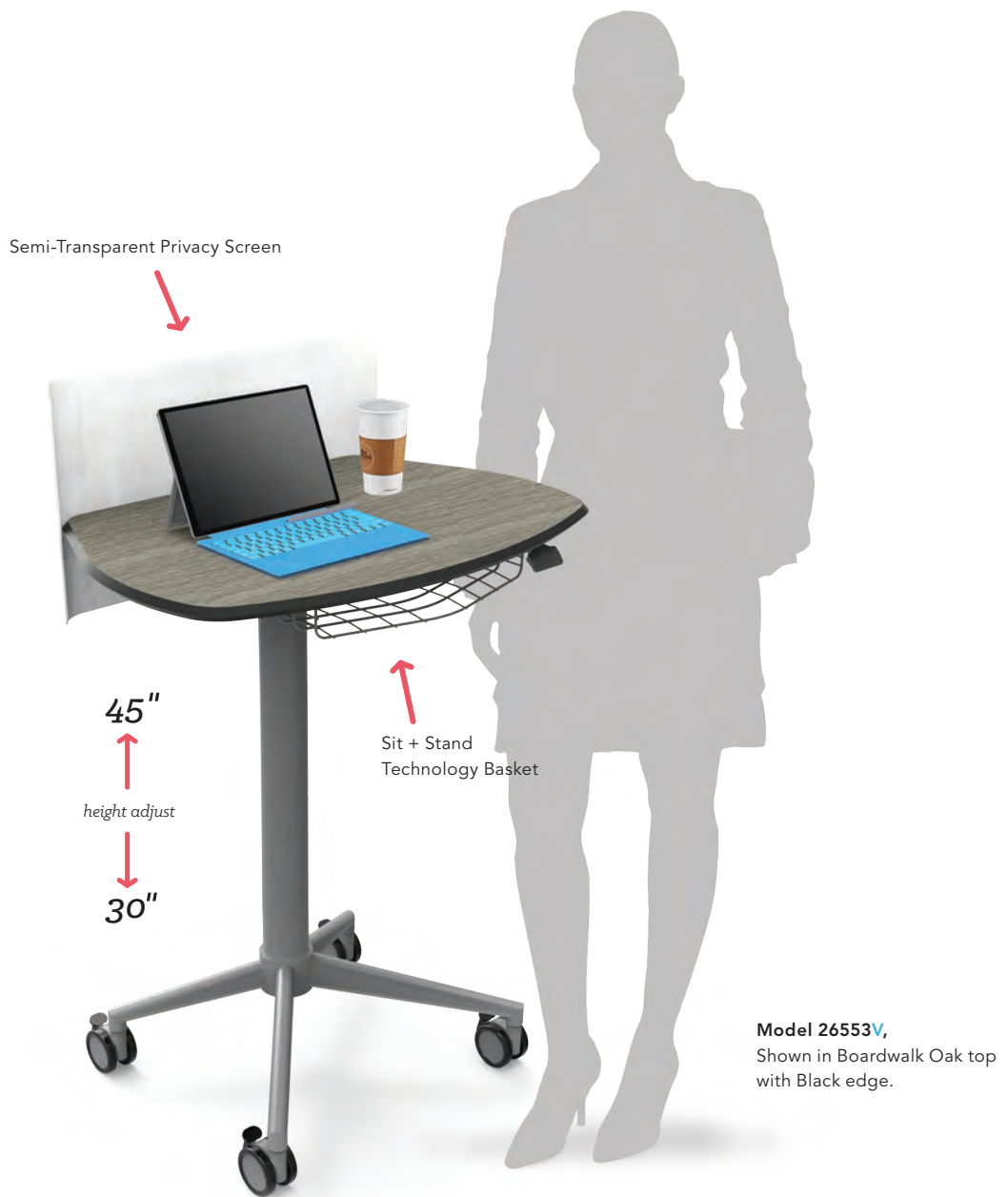

Model 26553V,
Shown in Boardwalk Oak top
with Black edge.

UXL Sit + Stand Teacher Lectern

The UXL Sit + Stand teacher lectern is a perfect addition to any classroom. Featuring a unique adjustable column that floats from 30 inches to 45 inches with the press of a lever. The semi-transparent privacy screen can be flipped up or down, with screws, to the teacher's preference of modesty panel (for sitting) or desktop privacy screen. Also, the lectern features a 10x14x3" depth basket for laptop or tablet storage. Screen and Technology Basket standard on teacher lectern unit. Available with 3/4" top only.

Model	Description	D"	W"	H"	F.C.	Cube	Wt.	UPS	List Price
26552V	UXL Sit + Stand Teacher Lectern with Rectangle Top	20	23.5	30-45"	85		44	*	\$ 1099.00
26553V	UXL Sit + Stand Teacher Lectern with Collaborative Top	21	30	30-45"	85		44	*	\$ 1099.00

Screen shown in
upward table top
privacy position.



Screen shown
in downward
modesty position.

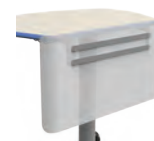





Tables UXL® Nest & Fold



Model FL2460ANGIPLT. Shown in Asian Night top with Navy edge and Platinum frame. Optional Theorem® Mobile Chairs, Model 44855.



Model FL60HRAMEBPLT. Shown in non-standard Amber Cherry top with Black edge and Platinum frame.

UXL Nest & Fold Table

FIXED HEIGHT

UXL Nest & Fold Tables provide a stable, spacious work surface and contemporary appearance. They offer added utility when not in use through their easy mobility and compact storage. Choose from 14 standard laminate colors, and 20 standard edge colors. Platinum frame only.

- UXL Nest & Fold Tables are standard with a 1 1/4" top with 3/8" Bumper T-Mold edge (**FL**).
- Optional top choice: 1 1/4" top with 4mm T-Mold edge. Replace **FL** in model number with **FM**.
- Easy to use release mechanism spans the top length.

Model	Description	D"	W"	H"	F.C.	Cube	Wt.	UPS	List Price
Rectangle									
FL2448___ _PLT	24"dx48"w UXL Nest & Fold Rectangle Top Table	24	48	30	70		102	*	\$ 899.00
FL2460___ _PLT	24"dx60"w UXL Nest & Fold Rectangle Top Table	24	60	30	70		110		\$ 949.00
FL2472___ _PLT	24"dx72"w UXL Nest & Fold Rectangle Top Table	24	72	30	70		118		\$ 975.00
FL3048___ _PLT	30"dx48"w UXL Nest & Fold Rectangle Top Table	30	48	30	70		112		\$ 949.00
FL3060___ _PLT	30"dx60"w UXL Nest & Fold Rectangle Top Table	30	60	30	70		120		\$ 999.00
FL3072___ _PLT	30"dx72"w UXL Nest & Fold Rectangle Top Table	30	72	30	70		128		\$ 1,049.00
Half Round									
FL48HR___ _PLT	48"w UXL Nest & Fold Half Round Top Table	26.5	48	30	70		82		\$ 949.00
FL60HR___ _PLT	60"w UXL Nest & Fold Half Round Top Table	30.25	60	30	70		90		\$ 999.00

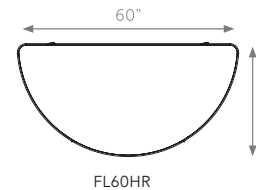
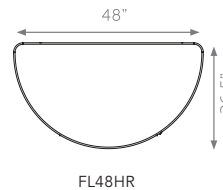
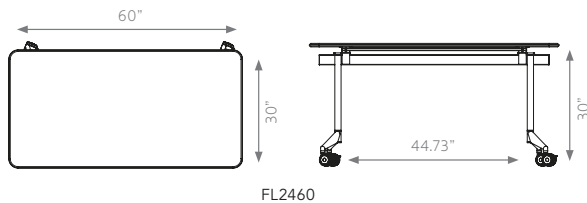



Model FL2460ANGIPLT. Shown in Asian Night top with Navy edge and Platinum frame. Optional Theorem® Mobile Chairs, Model 44855.

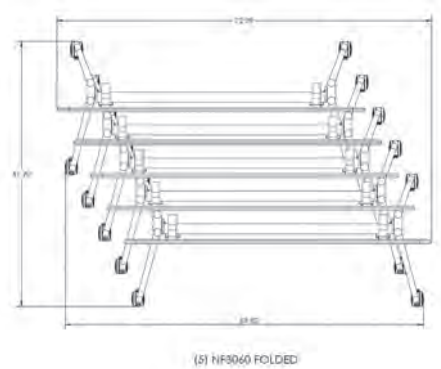

UXL Laminate Color Choice

- Asian Night **ANG** ● Classic Linen **CLN** ● Palisades Oak **PSO** ● New Age Oak **NEW** ● Grey Nebula **GNB**
- Boardwalk Oak **BWK** ● High Rise **HRE** ● Flax Linen **FLL** ● Wild Cherry **CHE** ● French Pear **FRP**
- Pewter Mesh **PEW** ● Buka Bark **BBK** ● Mission Maple **MIM** ● Fusion Maple **MAP**

UXL Edge Color Choice

- Apple **A** ● Burgundy **D** ● Charcoal **R** ● Forest Green **F** ● Mocha **T** ● Persian Blue **J** ● Red **L**
- Black **B** ● Cerulean **S** ● Chocolate **Q** ● Fuchsia **G** ● Navy **I** ● Platinum **P** ● Yellow **N**
- Blueberry **C** ● Champagne **O** ● Clementine **E** ● Mint **H** ● Orange **U** ● Purple **K**

Choose
FL
or
FM

7 8 9
Pick
Laminate
Color

10
Pick
Edge
Color

PLT
Leg set is
Platinum, 30"
fixed-height

View all finish options on page 271.

Tables UXL® Nest & Fold



Model AL3060PEWUPLT

Shown in Pewter Mesh top with Orange edge and Platinum frame. Optional Groove® Adjustable Stools, Model 33842.

UXL Laminate Color Choice

- | | | | | |
|----------------------------|----------------------------|----------------------------|---------------------------|--------------------------|
| ● Asian Night ANG | ● Classic Linen CLN | ● Palisades Oak PSO | ● New Age Oak NEW | ● Grey Nebula GNB |
| ● Boardwalk Oak BWK | ● High Rise HRE | ● Flax Linen FLL | ● Wild Cherry CHE | ● French Pear FRP |
| ● Pewter Mesh PEW | ● Buka Bark BBK | ● Mission Maple MIM | ● Fusion Maple MAP | |

Frame Choice

- | |
|-----------------------|
| ● Platinum PLT |
|-----------------------|

UXL Edge Color Choice

- | | | | | | | |
|----------------------|----------------------|-----------------------|-------------------------|-------------------|-------------------------|-------------------|
| ● Apple A | ● Burgundy D | ● Charcoal R | ● Forest Green F | ● Mocha T | ● Persian Blue J | ● Red L |
| ● Black B | ● Cerulean S | ● Chocolate Q | ● Fuchsia G | ● Navy I | ● Platinum P | ● Yellow N |
| ● Blueberry C | ● Champagne O | ● Clementine E | ● Mint H | ● Orange U | ● Purple K | |

View all finish options on page 271.



(6) Model AM3072ANGBPLT
Shown 36" and 29" heights with
24" Fixed Height Plato Stools
and 18" high Plato Stack Chairs.

UXL Nest & Fold Table

ADJUSTABLE HEIGHT

UXL Nest & Fold Adjustable Height Tables can be raised in one inch increments from 26" to 36". Choose from 14 standard laminate colors, and 20 standard edge colors. Platinum frame only.

- UXL Nest & Fold Tables are standard with a 1 1/4" top with 3/8" Bumper T-Mold edge (AL).
- Optional top choice: 1 1/4" top with 4mm T-Mold edge. Replace AL in model number with AM.
- Easy to use release mechanism spans the top length.
- Adjustable in one-inch increments with an Allen wrench.

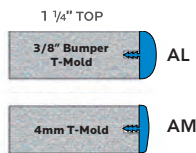

Choose
AL
or
AM

7 8 9

Pick
Laminate
Color

10

Pick
Edge
Color

PLT

Leg set is
Platinum,
26"-36"
adjustable-
height



Model	Description	D"	W"	H"	F.C.	Cube	Wt.	UPS	List Price
Adjustable Rectangle									
AL2448 ___ _ PLT	24"dx48"w Rectangle Adjustable Height	24	48	26-36	70		104	*	\$ 974.00
AL2460 ___ _ PLT	24"dx60"w Rectangle Adjustable Height	24	60	26-36	70		112		\$ 1,024.00
AL2472 ___ _ PLT	24"dx72"w Rectangle Adjustable Height	24	72	26-36	70		120		\$ 1,050.00
AL3048 ___ _ PLT	30"dx48"w Rectangle Adjustable Height	30	48	26-36	70		114		\$ 1,024.00
AL3060 ___ _ PLT	30"dx60"w Rectangle Adjustable Height	30	60	26-36	70		122		\$ 1,074.00
AL3072 ___ _ PLT	30"dx72"w Rectangle Adjustable Height	30	72	26-36	70		130		\$ 1,124.00
Adjustable Half Round									
AL48HR ___ _ PLT	48"w Half Round Adjustable Height	26.5	48	26-36	70		84		\$ 1,027.00
AL60HR ___ _ PLT	60"w Half Round Adjustable Height	30.25	60	26-36	70		92		\$ 1,074.00

Desks Silhouette®

Simple in form, these desks keep the focus on what matters most.





Silhouette Desk



Two-Student Silhouette



Arc Desk



Sequence Desk



Curve Desk



Technology Desk

The standard desk that sets a new standard.

Stable.

The Silhouette desk is a contemporary, economic solution for all classrooms. Its durable cantilevered design, adjustable legs and optional storage accessories make it a timeless favorite. Single- and two-student options are available.

Strong.

It provides a notably strong surface that can withstand heavy loads and daily wear. A practical backpack peg is standard. Optional accessories include steel book box, wire book basket and Cascade® Storage tote trays.

Stunning.

Sometimes, elegant simplicity is all you need in a student desk. That's where Silhouette shines.





BOOK FAIR
NOVEMBER
22

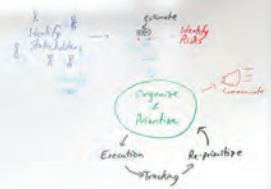



Desks Silhouette®



Model 01650. Shown in non-standard Blond Echo top with Platinum edge and Platinum frame. Optional SW tote tray, Model 30925 and optional 18" Flavors® Stack Chair, Model 11849.

Silhouette Desk — 18" and 20" Deep

The Silhouette Desk is a contemporary desk that combines elegant design, durability and functionality. It's stable and strong, and its leg design allows easy ingress and egress. A backpack peg is standard. Choose from three Bookbox options.

- Choose from three durable desktops, 1 1/4" thick or 3/4" thick with high-pressure laminate surface, or hard plastic.
- Cantilevered design allows easy ingress and egress.
- Adjustable leg height from 19"-31" in 1" increments. Only two (not four) legs to adjust.
- Rugged powder coat surface on legs resists wear.
- Lockable endcap/glide combination that resists tampering.
- Choose from fixed-height or adjustable frame.

Model	Description	D"	W"	H"	F.C.	Cube	Wt.	UPS	List Price
Single Student Desk									
01600	Silhouette Desk Single-Student	18	24	19-31	70	1.2	36	*	\$ 169.00
01602	Silhouette Desk Single-Student, Fixed-Height, w/glides	18	24	29.5	70	1.2	36	*	\$ 169.00
01603	Silhouette Desk Single-Student, Fixed-Height, w/casters	18	24	29.5	70	1.2	36	*	\$ 245.00
01650	Silhouette Desk Single-Student	20	27	19-31	70	1.3	40	*	\$ 179.00
01649	Silhouette Desk Single-Student, Fixed-Height, w/glides	20	27	29.5	70	1.3	40	*	\$ 179.00
01648	Silhouette Desk Single-Student, Fixed-Height, w/casters	20	27	29.5	70	1.3	40	*	\$ 255.00
Two Student Desks (Available in 1 1/4" top only)									
01660	Silhouette Desk Two-Student (Available in 1 1/4" top only)	20	48	19-31	70	1.3	75	*	\$ 249.00
01662	Silhouette Desk Two-Student, Fixed-Height, w/glides	20	48	29.5	70	1.3	75	*	\$ 249.00
01664	Silhouette Desk Two-Student, Fixed-Height, w/casters	20	48	29.5	70	1.3	75	*	\$ 325.00
01661	Silhouette Desk Two-Student (Available in 1 1/4" top only)	20	54	19-31	70	1.4	79	*	\$ 269.00
01663	Silhouette Desk Two-Student, Fixed-Height, w/glides	20	54	29.5	70	1.4	79	*	\$ 269.00
01665	Silhouette Desk Two-Student, Fixed-Height, w/casters	20	54	29.5	70	1.4	79	*	\$ 345.00

Silhouette Desk Laminate Color Choice				Frame Choice		
● Asian Night	● Classic Linen	● Palisades Oak	● New Age Oak	● Grey Nebula	● Black	
● Boardwalk Oak	● High Rise	● Flax Linen	● Wild Cherry	● French Pear	● Platinum	
● Pewter Mesh	● Buka Bark	● Mission Maple	● Fusion Maple			
Silhouette Desk Edge Color Choice						
● Apple	● Burgundy	● Charcoal	● Forest Green	● Mocha	● Persian Blue	● Red
● Black	● Cerulean	● Chocolate	● Fuchsia	● Navy	● Platinum	● Yellow
● Blueberry	● Champagne	● Clementine	● Mint	● Orange	● Purple	

View all finish options on page 271.



Model 01661. Shown in Asian Night top with Fuchsia edge and Platinum frame. A practical backpack peg is standard.

Model (2) 01650 and (1) 01661
Shown in Boardwalk Oak top with Mint edge and Platinum frame. Also, Groove® Mobile Chairs in Mint.

NEW!



Model 01671. Shown in Mission top with Platinum edge and Platinum frame. Optional 3" casters, paired with Groove 24" Fixed Height Stool.



Make it mobile.
Order Model 17576
\$ 76.00 List

Silhouette Desk — 24" Deep

The Silhouette Desk is a contemporary desk that combines elegant design, durability and functionality. It's stable and strong, and its leg design allows easy ingress and egress. A backpack peg is standard. Choose from three Bookbox options.

- Adjustable leg height from 22"-34" in 1" increments. Only two (not four) legs to adjust.
- Add 3" Casters, to achieve desktop height of 36"h to pair with 24" Stools.
- Rugged powder coat surface on legs resists wear.
- Lockable endcap/glide combination that resists tampering.

Model	Description	D"	W"	H"	F.C.	Cube	Wt.	UPS	List Price
Single Student Desks									
01670	Silhouette Desk	Single-Student	24	27	22-34	70		*	\$ 249.00
01671	Silhouette Desk	Single-Student	24	30	22-34	70		*	\$ 289.00
Two Student Desks (Available in 1 1/4" top only)									
01675	Silhouette Desk	Two-Student (Available in 1 1/4" top only)	24	48	22-34	70		*	\$ 355.00
01676	Silhouette Desk	Two-Student (Available in 1 1/4" top only)	24	54	22-34	70			\$ 389.00
01677	Silhouette Desk	Two-Student (Available in 1 1/4" top only)	24	60	22-34	70		*	\$ 425.00

Desks Silhouette®



Silhouette Arc-8 Desk, Model 01620
Shown in Palisades Oak top with Orange edge and Platinum frame. Shown with optional casters and Flavors Stack Chair, Model 11849.



Technology Basket
Model 17018



Steel Bookbox
Model 17016



Tote Tray
Model 30925 or 30926

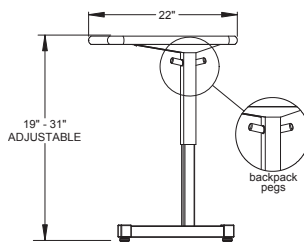
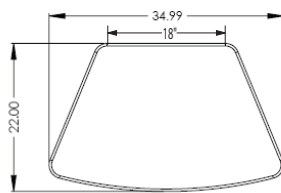

Patented backpack peg keeps student items organized, can be positioned inside or outside of either leg.

Silhouette Arc-8 Desk

Chosen for collaborative learning classrooms, the stable Arc-8 Desk offers ample workspace and exceptional ingress and egress to the student — crucial in an active classroom. This design saves time whenever she/he stands up or sits down. Choose from 14 standard laminate colors, 20 standard edge colors and Black or Platinum frame colors.

- Leg shape allows easy ingress and egress for students.
- Desk height adjusts from 19"-31" in 1" increments. Only two legs to adjust.
- Durable desktop available in 1 1/4" or 3/4" thickness, all with a high-pressure laminate surface.
- Edge moldings resist wear, choices available (see chart).
- Rugged powder coat surface on legs resists wear.

Model	Description	D"	W"	H"	F.C.	Cube	Wt.	UPS	List Price
01620	Silhouette Arc-8 Desk	22	35	19-31	70	4.0	45	*	\$ 255.00
01621	Silhouette Arc-8 Desk	Fixed height w/glides	22	35	29.5	70	4.0	45	\$ 255.00
01622	Silhouette Arc-8 Desk	Fixed height w/casters	22	35	29.5	70	4.0	45	\$ 315.00
Optional Accessories									
17576	3" Dual-Wheel Caster Pack (Set of 4, 4 locking)-BLACK			3	70	0.5	5	*	\$ 76.00
17577	3" Dual-Wheel Caster Pack (Set of 4, 4 locking)-COLORS			3	70	0.5	5	*	\$ 96.00
<i>*Model 17577 comes in your choice of Apple APL, Cerulean CER, Charcoal CGR, Orange ORG or Platinum PLT.</i>									
30925	SW (Standard Width) Tote Tray w/housing	16.8	13.5	3	70	1.13	10	*	\$ 93.00
30926	EW (Extra Wide) Tote Tray w/housing	16.8	19.6	3	70	1.13	8	*	\$ 103.00
17016	Steel Bookbox for Arc Desk	15	21	3.5	70	3.0	6	*	\$ 65.00
17018	Technology Basket	13	10	2	70	3.0	1	*	\$ 59.00

Arc Desk Laminate Color Choice

● Asian Night	● Classic Linen	● Palisades Oak	● New Age Oak	● Grey Nebula
● Boardwalk Oak	● High Rise	● Flax Linen	● Wild Cherry	● French Pear
● Pewter Mesh	● Buka Bark	● Mission Maple	● Fusion Maple	

Frame Choice

● Black
● Platinum

Arc Desk Edge Color Choice

● Apple	● Burgundy	● Charcoal	● Forest Green	● Mocha	● Persian Blue	● Red
● Black	● Cerulean	● Chocolate	● Fuchsia	● Navy	● Platinum	● Yellow
● Blueberry	● Champagne	● Clementine	● Mint	● Orange	● Purple	

View all finish options on page 271.

Create circular collaborative areas for students in groups of up to 8.



Silhouette Arc-8 Desks, Model 01620
Shown in Palisades Oak top with Champagne edge and Platinum Frames. Shown with optional casters and Flavors Stack Chairs, 11849.

Desks Silhouette®

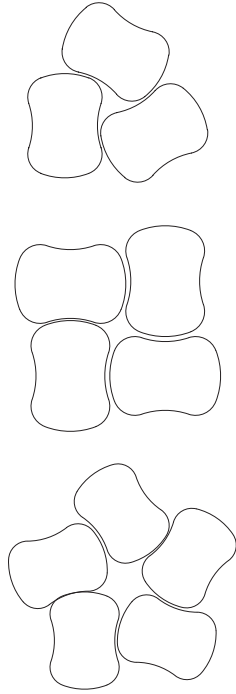

Model 01659
Shown in New Age Oak with Cerulean edge and Platinum fixed-height frame with casters and SW tote, Model 30925.

Silhouette Sequence® Desk

The Silhouette Sequence Desk is a contemporary desk for collaborative classrooms, combining elegant design, durability and functionality. It's stable and strong, and its leg design allows easy ingress and egress. A backpack peg is standard. Choose from three Bookbox options.

Model	Description	D"	W"	H"	F.C.	Cube	Wt.	UPS	List Price
01655	Silhouette Sequence Desk, Single-Student	23	31	19-31	70	1.2	36	*	\$ 225.00
01658	Silhouette Sequence Desk, Single-Student, Fixed-Height, w/glides	23	31	29.5	70	1.2	36	*	\$ 225.00
01659	Silhouette Sequence Desk, Single-Student, Fixed-Height, w/casters	23	31	29.5	70	1.2	36	*	\$ 301.00



Make it mobile.
Order Model 17576
\$ 76.00 List

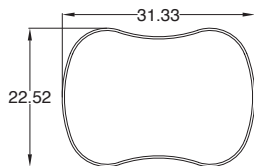

Silhouette Sequence desk's unique shape adapts to both traditional and collaborative environments.

Silhouette Desks Have Top and Edge Choices

1 1/4" Tops

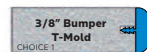

CHOICE 1 – 1 1/4" top with Bumper T-Mold no letter to follow Model No.

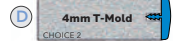

CHOICE 2 – 1 1/4" top with 4mm T-Mold **D** to follow Model No.

3/4" Tops



CHOICE 3 – 3/4" top with 4mm T-Mold **C** to follow Model No.



CHOICE 4 – 3/4" top with Bullet T-Mold **V** to follow Model No.

*Two-Student desks use 1 1/4" tops.

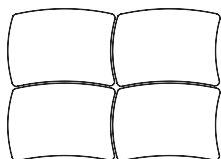
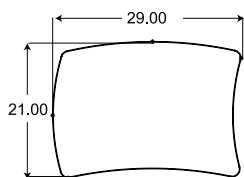

Model 01654
Shown in New Age Oak top with Cerulean edge and Platinum fixed-height frame with SW tote, Model 30925.

Silhouette Curve Desk

The Silhouette Curve Desk is a contemporary desk for transitional classrooms, combining elegant design, durability and functionality. It's stable and strong, and its leg design allows easy ingress and egress. A backpack peg is standard. Choose from three Bookbox options.

Model	Description	D"	W"	H"	F.C.	Cube	Wt.	UPS	List Price
01653	Silhouette Curve Desk, Single-Student	21	29	19-31	70	1.2	36	*	\$ 225.00
01654	Silhouette Curve Desk, Single-Student, Fixed-Height, w/glides	21	29	29.5	70	1.2	36	*	\$ 225.00
01657	Silhouette Curve Desk, Single-Student, Fixed-Height, w/casters	21	29	29.5	70	1.2	36	*	\$ 301.00

Silhouette Desk Laminate Color Choice

● Asian Night	● Classic Linen	● Palisades Oak	● New Age Oak	● Grey Nebula
● Boardwalk Oak	● High Rise	● Flax Linen	● Wild Cherry	● French Pear
● Pewter Mesh	● Buka Bark	● Mission Maple	● Fusion Maple	

Frame Choice

● Black
● Platinum

Silhouette Desk Edge Color Choice

● Apple	● Burgundy	● Charcoal	● Forest Green	● Mocha	● Persian Blue	● Red
● Black	● Cerulean	● Chocolate	● Fuchsia	● Navy	● Platinum	● Yellow
● Blueberry	● Champagne	● Clementine	● Mint	● Orange	● Purple	

View all finish options on page 271.

Desks Silhouette® Accessories



Fixed height
29.5"

Fixed height,
with Caster,
29.5"

Adjustable height,
with optional Caster
21-33" (18" & 20"D)
24-36" (24"D)

Adjustable height
on glide
19-31" (18" & 20"D)
or 22-34" (24"D)

Sit, stand, roll, stop.
Multiple leg options
for multiple
classroom needs.

Silhouette Desks Have Top and Edge Choices

1 1/4" Tops



CHOICE 1 – 1 1/4" top with Bumper T-Mold
no letter to follow Model No.



CHOICE 2 – 1 1/4" top with 4mm T-Mold
D to follow Model No.

3/4" Tops



CHOICE 3 – 3/4" top with 4mm T-Mold
C to follow Model No.



CHOICE 4 – 3/4" top with Bullet T-Mold
V to follow Model No.

*Two-Student desks use 1 1/4" tops.



Model 01661

Shown in Wild Cherry top with Black Bumper T-Mold and Black frame. Shown with two optional Steel Bookboxes, Model 17190.

Silhouette Desk Laminate Color Choice

● Asian Night	● Classic Linen	● Palisades Oak	● New Age Oak	● Grey Nebula
● Boardwalk Oak	● High Rise	● Flax Linen	● Wild Cherry	● French Pear
● Pewter Mesh	● Buka Bark	● Mission Maple	● Fusion Maple	

Frame Choice

● Black
● Platinum

Silhouette Desk Edge Color Choice

● Apple	● Burgundy	● Charcoal	● Forest Green	● Mocha	● Persian Blue	● Red
● Black	● Cerulean	● Chocolate	● Fuchsia	● Navy	● Platinum	● Yellow
● Blueberry	● Champagne	● Clementine	● Mint	● Orange	● Purple	

View all finish options on page 271.

Silhouette Accessories

Model	Description	D"	W"	H"	F.C.	Cube	Wt.	UPS	List Price
Silhouette Desk Accessories									
17190	Steel Bookbox – for 18 x 24 & 20 x 27 desk	15	20	4	70	3.0	8	*	\$ 61.00
17200	Wire Book Basket	15	18	3.5	70	3.0	5	*	\$ 51.00
30925	SW (Standard Width) Tote Tray w/housing	16.8	13.5	3	70	1.13	8	*	\$ 93.00
30926	EW (Extra Wide) Tote Tray w/housing	16.8	19.6	3	70	1.13	10	*	\$ 103.00
17016	Steel Bookbox – for Silhouette Arc-8 desk	15	21	3.5	70	3.0	6	*	\$ 65.00
17018	Technology Basket	13	10	2	70	3.0	1	*	\$ 59.00
17576	3" Dual-Wheel Caster, Set of 4, 4 locking. BLACK.				70	0.1	5	*	\$ 76.00
17577_ _ _	3" Dual-Wheel Caster, Set of 4, 4 locking. COLOR*.				70	0.1	5	*	\$ 96.00
*Model 17577 comes in your choice of Apple <i>APL</i> , Cerulean <i>CER</i> , Charcoal <i>CGR</i> , Orange <i>ORG</i> or Platinum <i>PLT</i> .									



**Steel Bookbox
Model 17190**
Durable Steel Bookbox in rugged Black or Platinum powder coat finish.



**Technology Basket
Model 17018**
Wire basket for small electronics or books.



**Wire Book Basket
Model 17200**
Wire Book Basket in rugged Black powder coat finish.

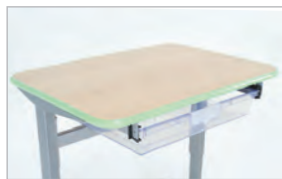

**Extra Wide Tote Tray
Model 30926**
Translucent EW tote tray interfaces with Cascade® Storage Units that hold EW Trays.

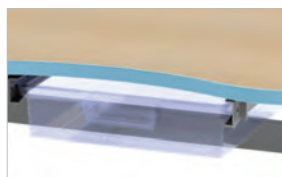

**Standard Width Tote Tray
Model 30925**
Translucent SW tote tray interfaces with Cascade Storage Units that hold SW Trays.



Model 01650
Shown in Fusion Maple top with Mint Bumper T-Mold and Platinum frame. Shown with optional Steel Bookbox, Model 17190. Shown with optional 18" In2it Chair, Model 00509.



Model 01600C
Shown in non-standard Grey Mesh top with Apple edge and Platinum frame. Shown with optional EW tote tray, Model 30926. Shown with optional 18" Plato Stack Chair, Model 00950.

Technology Desks Flexline™



Model 01378

Shown in Classic Linen top with Cerulean edge and Platinum frame. Shown with optional 3" casters, Model 17577. Shown with optional Plato Adjustable Chairs.

Flexline Technology Desk

Choose the Flexline Technology Desk for easy ingress/egress for students, a strong, stable work surface and for its ingenious Wire Manager that keeps cabling stowed neatly out of sight. Features two handy backpack pegs. Choose from 14 standard laminate colors, 20 standard edge colors and two frame colors.

- Durable desktop is 1¼" thick with a high-pressure laminate surface.
- Edge moldings resist wear, choose Bumper T-Mold (standard) or 4mm T-Mold.
- For maximum stability, a 14-gauge steel mounting plate is welded to a Y-Leg made of 16-gauge steel tubing.
- Our patented backpack peg is on both the right and left leg, allowing backpacks to be hung under or outside the desk.
- Legs adjust from 19" to 31" high in 1" increments.

Model	Description	D"	W"	H"	F.C.	Cube	Wt.	UPS	List Price
24" Deep Models									
01377	Flexline Technology Desk w/Tilt Down Wire Manager	24	60	19-31	70	7.0	96		\$ 501.00
01378	Flexline Technology Desk w/Tilt Down Wire Manager	24	72	19-31	70	8.5	106		\$ 563.00



CPU Holder, Model 17213
 Adjusts 8.5 – 11.6" wide
 and 16.75 – 21.25" high.
 Black steel. Locks.
 \$ 159.00.



**ADD
POWER**
 DETAILS ON PAGE 272



Model 17081



Model 17084



Model 17107

4-Plug Power Socket is durable and attaches securely to the work surface. Model 17107 with 15 ft. long cord.

Model	Description	D"	W"	H"	F.C.	Cube	WT.	UPS	List Price
Power Module/Surge Protectors									
17081	6 Outlet Electric Strip w/Surge, 4' Cord	3	3	12	70	0.1	4	*	\$ 65.00
17084	10 Outlet Electric Strip w/Surge, 15' Cord	3	8	12	70	0.1	5	*	\$ 152.00
17107	4 Plug Power Outlet w/15' cord	2.8	6.6	3.3	70		4		\$ 375.00
Caster Options									
17576	3" Dual-Wheel Caster, Set of 4, 4 locking. BLACK.	3" dia.		3	70	0.1	5	*	\$ 76.00
17577 _ _ _	3" Dual-Wheel Caster, Set of 4, 4 locking. COLOR*	3" dia.		3	70	0.1	5	*	\$ 96.00
*Model 17577 comes in your choice of Apple APL , Cerulean CER , Charcoal CGR , Orange ORG or Platinum PLT .									
17554	4" Dual-Wheel Caster Pack, Set of 4, 2 locking	4" dia.		4	70	0.2	5	*	\$ 107.00



All Flexline Technology Desks come standard with modesty panel and wire manager management.

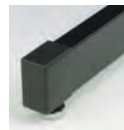

Lockable end-cap/glide combination resists tampering.



Make it mobile
 Order Model 17576
 \$ 76.00 List

Flexline Technology Desks Have Top and Edge Choices

1 1/4" Tops

CHOICE 1
 3/8" Bumper T-Mold
 CHOICE 1

1 1/4" top with Bumper T-Mold
 no letter to follow Model No.

CHOICE 2
 4mm T-Mold
 CHOICE 2

1 1/4" top with 4mm T-Mold
 D to follow Model No.

Flexline Technology Desk Laminate Color Choice

- | | | | | |
|-----------------|-----------------|-----------------|----------------|---------------|
| ● Asian Night | ● Classic Linen | ● Palisades Oak | ● New Age Oak | ● Grey Nebula |
| ● Boardwalk Oak | ● High Rise | ● Flax Linen | ● Wild Cherry | ● French Pear |
| ● Pewter Mesh | ● Buka Bark | ● Mission Maple | ● Fusion Maple | |

Leg Color Choice

- Black
- Platinum

Flexline Technology Desk Edge Color Choice

- | | | | | | | |
|-------------|-------------|--------------|----------------|----------|----------------|----------|
| ● Apple | ● Burgundy | ● Charcoal | ● Forest Green | ● Mocha | ● Persian Blue | ● Red |
| ● Black | ● Cerulean | ● Chocolate | ● Fuchsia | ● Navy | ● Platinum | ● Yellow |
| ● Blueberry | ● Champagne | ● Clementine | ● Mint | ● Orange | ● Purple | |

View all finish options on page 271.

Maximum strength
and stability for a wide
variety of applications.





Studio Tables



Studio Whiteboard



Studio Benches



Activity Tables



Science Tables



Student Desks



Computer Tables

Stable foundation.

What sets Planner desks and tables apart is their rock-solid bases.

- Steel legs, one at each corner, welded to two steel cross members at each corner.
- Heavy gauge steel modesty panel bolted to each leg across the front.

Unbeatable construction.

- T-Mold edge bands on Planner desks and tables are stapled every 6 inches to provide superior fastening power.
- The work surfaces are high-pressure laminate that stand up to heavy use.

For collaborative learning or traditional classrooms.

- Huddle desks provide tremendous durability in collaborative learning classrooms.
- Planner student desks offer the same strengths in traditional classrooms.

Healthy construction.

- UL GREENGUARD Gold Certified.

Offering flexibility, functionality and mobility.

- Planner student desks are available in a variety of sizes including two- and three-student models.
- Huddle desks are available in three sizes.
- Built-in backpack pegs keep classrooms tidy.
- Steel Bookboxes and caster sets available.

Planner activity tables' versatility is a strength.

- Work surfaces available in Trapezoid, Square, Round, Half-Moon and Contour shapes.
- Trespa® TopLab® Plus surfaces available for labs and art rooms.
- Modesty panels available.

Dependability.

- Lifetime warranty on the frame and legs, 12-year warranty on table and desktops.

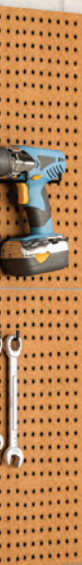



Tables Planner® Studio



Planner Studio Tables — 30", 36" & 42" Deep

These tables are designed to meet the needs of today's creative learning spaces. These sophisticated 29"h, 36"h and 40"h tables meet the demanding needs of your Makerspace, without the pared down "shop-class" aesthetics. The adaptive urban industrial style allows for crossover application in media centers, active learning spaces, common areas or any space that encourages collaboration and social learning.

- Strong, 14-gauge steel legs are protected with a durable powder coat surface.
- Sturdy 1 1/4" desktop with a high-pressure laminate surface.
- 3mm flat edges.
- 3 top colors and 5 leg color choices. 30" D Platinum leg only.
- Optional second surface shelf kits available on stand-up models 36" & 40", in Grey only.
- Optional foot rest available for 30", 36" & 42" height Studio tables, Platinum finish only.
- Planner Studio comes standard with 4" diameter casters, with all 4 wheels lockable.

Planner Studio Laminate Color Choice

- Pewter Mesh **PEW**
w/matching 3mm edge
- Mission Maple **MIM**
w/matching 3mm edge
- Whiteboard **FWB** *
w/Grey [North Sea] 3mm edge

Planner Studio Leg Color Choice

- Apple **AP**
- Cerulean **CE**
- Charcoal **CG**
- Orange **OR**
- Platinum **PL**

Planner Studio Has ONE Top and Edge Profile

- **F** 3mm Edge 1 1/4" top with 3mm flat edge. *Standard 3/8" bumper edges available, no letter to follow Model No.

Planner Studio Has THREE Top Color Options

- Choice 1 – Pewter Mesh top/matching 3mm edge
- Choice 2 – Mission Maple top/matching 3mm edge
- *Choice 3 – Whiteboard top/Grey "North Sea" 3mm edge

- * Whiteboard laminate top, add \$125 to list price.
- * Whiteboard laminate surface has a 1-year warranty.

Tables that meet the demanding needs of today's creative learning spaces.



48x60 Planner Studio, Model 25244f
36"h, Shown in Pewter Mesh with Apple legs and optional 24" Plato® stools.

Accessories



Model	Description	D"	W"	H"	F.C.	Cube	WT	List Price
Second Surface Shelf Kits (Shelf Kit is finished in Grey only) for 36" and 40" h								
77250	Second Surface Kit for 48"w – 36"d/42"d Studio Tables				70	41		\$ 250.00
77251	Second Surface Kit for 60"w – 36"d/42"d Studio Tables				70	45		\$ 300.00
77252	Second Surface Kit for 72"w – 36"d/42"d Studio Tables				70	57		\$ 350.00
Foot Rests (for 36" h & 40" h Planner Studio Tables, Platinum only)								
77244	(x2) 48" w Planner Studio Foot Rest				70	19		\$ 245.00
77245	(x2) 60" w Planner Studio Foot Rest				70	21		\$ 245.00
77246	(x2) 72" w Planner Studio Foot Rest				70	26		\$ 245.00

Tables Planner® Studio

Planner Studio Tables — 36" & 42" Deep

Model	Description	D"	W"	H"	F.C.	Cube	WT	List Price
36" Deep Models								
25200F	Planner Studio 36x48 Table	29" Fixed-Height w/casters	36	48	29	70	112	\$ 995.00
25201F	Planner Studio 36x48 Table	29" Fixed-Height w/glides	36	48	29	70	112	\$ 995.00
25202F	Planner Studio 36x48 Table	36" Fixed-Height w/casters	36	48	36	70	115	\$ 1,025.00
25203F	Planner Studio 36x48 Table	36" Fixed-Height w/glides	36	48	36	70	115	\$ 1,025.00
25204F	Planner Studio 36x48 Table	40" Fixed-Height w/casters	36	48	40	70	119	\$ 1,050.00
25205F	Planner Studio 36x48 Table	40" Fixed-Height w/glides	36	48	40	70	119	\$ 1,050.00
25206F	Planner Studio 36x60 Table	29" Fixed-Height w/casters	36	60	29	70	127	\$ 1,050.00
25207F	Planner Studio 36x60 Table	29" Fixed-Height w/glides	36	60	29	70	127	\$ 1,050.00
25208F	Planner Studio 36x60 Table	36" Fixed-Height w/casters	36	60	36	70	130	\$ 1,075.00
25209F	Planner Studio 36x60 Table	36" Fixed-Height w/glides	36	60	36	70	130	\$ 1,075.00
25210F	Planner Studio 36x60 Table	40" Fixed-Height w/casters	36	60	40	70	134	\$ 1,100.00
25211F	Planner Studio 36x60 Table	40" Fixed-Height w/glides	36	60	40	70	134	\$ 1,100.00
25212F	Planner Studio 36x72 Table	29" Fixed-Height w/casters	36	72	29	70	143	\$ 1,150.00
25213F	Planner Studio 36x72 Table	29" Fixed-Height w/glides	36	72	29	70	143	\$ 1,150.00
25214F	Planner Studio 36x72 Table	36" Fixed-Height w/casters	36	72	36	70	146	\$ 1,175.00
25215F	Planner Studio 36x72 Table	36" Fixed-Height w/glides	36	72	36	70	146	\$ 1,175.00
25216F	Planner Studio 36x72 Table	40" Fixed-Height w/casters	36	72	40	70	150	\$ 1,200.00
25217F	Planner Studio 36x72 Table	40" Fixed-Height w/glides	36	72	40	70	150	\$ 1,200.00
42" Deep Models								
25218F	Planner Studio 42x48 Table	29" Fixed-Height w/casters	42	48	29	70	120	\$ 1,050.00
25219F	Planner Studio 42x48 Table	29" Fixed-Height w/glides	42	48	29	70	120	\$ 1,050.00
25220F	Planner Studio 42x48 Table	36" Fixed-Height w/casters	42	48	36	70	123	\$ 1,075.00
25221F	Planner Studio 42x48 Table	36" Fixed-Height w/glides	42	48	36	70	123	\$ 1,075.00
25222F	Planner Studio 42x48 Table	40" Fixed-Height w/casters	42	48	40	70	127	\$ 1,100.00
25223F	Planner Studio 42x48 Table	40" Fixed-Height w/glides	42	48	40	70	127	\$ 1,100.00
25224F	Planner Studio 42x60 Table	29" Fixed-Height w/casters	42	60	29	70	138	\$ 1,125.00
25225F	Planner Studio 42x60 Table	29" Fixed-Height w/glides	42	60	29	70	138	\$ 1,125.00
25226F	Planner Studio 42x60 Table	36" Fixed-Height w/casters	42	60	36	70	141	\$ 1,150.00
25227F	Planner Studio 42x60 Table	36" Fixed-Height w/glides	42	60	36	70	141	\$ 1,150.00
25228F	Planner Studio 42x60 Table	40" Fixed-Height w/casters	42	60	40	70	145	\$ 1,175.00
25229F	Planner Studio 42x60 Table	40" Fixed-Height w/glides	42	60	40	70	145	\$ 1,175.00
25230F	Planner Studio 42x72 Table	29" Fixed-Height w/casters	42	72	29	70	156	\$ 1,225.00
25231F	Planner Studio 42x72 Table	29" Fixed-Height w/glides	42	72	29	70	156	\$ 1,225.00
25232F	Planner Studio 42x72 Table	36" Fixed-Height w/casters	42	72	36	70	159	\$ 1,250.00
25233F	Planner Studio 42x72 Table	36" Fixed-Height w/glides	42	72	36	70	159	\$ 1,250.00
25234F	Planner Studio 42x72 Table	40" Fixed-Height w/casters	42	72	40	70	163	\$ 1,275.00
25235F	Planner Studio 42x72 Table	40" Fixed-Height w/glides	42	72	40	70	163	\$ 1,275.00



Planner Studio Power Strip

Model	Description	D"	W"	H"	F.C.	Cube	WT	List Price
77248	Planner Studio Power Strip	6.82	7.52	3.18	70	1	4	\$ 199.00



36" d x 60" w Planner Studio,
Model 25210TRESPA/PL
40" h, Shown in Trespa Black top
with and Platinum legs.



**CHEMICAL
& FLAME
RESISTANT**

Planner Studio Tables — 36" Deep Trespa®

The Planner Studio table with Trespa TopLab top is designed to meet the needs of demanding creative and science learning spaces. The ½" thick work surface consists of Trespa TopLab® PLUS material, which is resistant to a large number of aggressive chemicals as identified by SEFA (Scientific Equipment and Furniture Association) and PSI (Professional Services Industries), if cleaned within 24 hours.

- Strong, 14-gauge steel legs are protected with a durable powder coat surface.
- Trespa Planner Studio is available in 36x60" size only.

Model	Description		D"	W"	H"	F.C.	Cube	WT	List Price
36" x 60" Trespa Work Surface Models			<i>(Trespa top available in 36"x60" size only).</i>						
25206TRESPA/_ _	Planner Studio 36x60	29" Fixed-Height w/casters	36	60	29	70		127	\$ 2,250.00
25207TRESPA/_ _	Planner Studio 36x60	29" Fixed-Height w/glides	36	60	29	70		127	\$ 2,250.00
25208TRESPA/_ _	Planner Studio 36x60	36" Fixed-Height w/casters	36	60	36	70		130	\$ 2,275.00
25209TRESPA/_ _	Planner Studio 36x60	36" Fixed-Height w/glides	36	60	36	70		130	\$ 2,275.00
25210TRESPA/_ _	Planner Studio 36x60	40" Fixed-Height w/casters	36	60	40	70		134	\$ 2,300.00
25211TRESPA/_ _	Planner Studio 36x60	40" Fixed-Height w/glides	36	60	40	70		134	\$ 2,300.00

Planner Studio Leg Color Choice

- Apple AP
- Cerulean CE
- Charcoal CG
- Orange OR
- Platinum PL

Tables Planner® Studio



48" d x 72" w Planner Studio, Model 25250f
36" h, Shown in Mission Maple top with
matching 3mm edge and Apple legs.

Accessories



Model	Description	D"	W"	H"	F.C.	Cube	WT	List Price
Second Surface Shelf Kits (Shelf Kit is finished in Grey only) for 36" and 40" h only.								
77253	Second Surface Kit for 48" d x 48" w Studio Tables					70	51	\$ 350.00
77254	Second Surface Kit for 48" d x 60" w Studio Tables					70	57	\$ 400.00
77255	Second Surface Kit for 48" d x 72" w Studio Tables					70	71	\$ 450.00
Foot Rests (for 36" h & 40" h Planner Studio Tables, Platinum only)								
77244	(x2) 48" w Planner Studio Foot Rest					70	19	\$ 245.00
77245	(x2) 60" w Planner Studio Foot Rest					70	21	\$ 245.00
77246	(x2) 72" w Planner Studio Foot Rest					70	26	\$ 245.00
Power Strip								
77248	Planner Studio Power Strip	6.82	7.52	3.18	70	1	4	\$ 199.00
Backpack Hook								
77249	Planner Studio Backpack Hook	3	3	3			2	\$ 20.00



48" d x 60" w Planner Studio, Model 25246f
40" h, Shown in Mission Maple top with matching 3mm edge and Platinum legs.

Planner Studio Tables — 48" Deep

These tables are designed to meet the needs of today's creative learning spaces. These sophisticated 29" h, 36" h and 40" h tables meet the demanding needs of your Makerspace, without the pared down "shop-class" aesthetics. The adaptive urban industrial style allows for crossover application in media centers, active learning spaces, common areas or any space that encourages collaboration and social learning.

- Strong, 14-gauge steel legs are protected with a durable powder coat surface.
- Sturdy 1 1/4" desktop with a high-pressure laminate surface.
- Optional second surface shelf kits available, in Grey only.
- Optional foot rest available for 36" & 42" height Studio tables, Platinum finish only.
- Planner Studio comes standard with 4" diameter casters, with all 4 wheels lockable.

Model	Description		D"	W"	H"	F.C.	Cube	WT	List Price
48" Deep Models									
25236F	Planner Studio 48x48 Table	29" Fixed-Height w/casters	48	48	29	70		143	\$ 1,200.00
25237F	Planner Studio 48x48 Table	29" Fixed-Height w/glides	48	48	29	70		143	\$ 1,200.00
25238F	Planner Studio 48x48 Table	36" Fixed-Height w/casters	48	48	36	70		146	\$ 1,225.00
25239F	Planner Studio 48x48 Table	36" Fixed-Height w/glides	48	48	36	70		146	\$ 1,225.00
25240F	Planner Studio 48x48 Table	40" Fixed-Height w/casters	48	48	40	70		150	\$ 1,250.00
25241F	Planner Studio 48x48 Table	40" Fixed-Height w/glides	48	48	40	70		150	\$ 1,250.00
25242F	Planner Studio 48x60 Table	29" Fixed-Height w/casters	48	60	29	70		165	\$ 1,325.00
25243F	Planner Studio 48x60 Table	29" Fixed-Height w/glides	48	60	29	70		165	\$ 1,325.00
25244F	Planner Studio 48x60 Table	36" Fixed-Height w/casters	48	60	36	70		168	\$ 1,350.00
25245F	Planner Studio 48x60 Table	36" Fixed-Height w/glides	48	60	36	70		168	\$ 1,350.00
25246F	Planner Studio 48x60 Table	40" Fixed-Height w/casters	48	60	40	70		172	\$ 1,375.00
25247F	Planner Studio 48x60 Table	40" Fixed-Height w/glides	48	60	40	70		172	\$ 1,375.00
25248F	Planner Studio 48x72 Table	29" Fixed-Height w/casters	48	72	29	70		188	\$ 1,450.00
25249F	Planner Studio 48x72 Table	29" Fixed-Height w/glides	48	72	29	70		188	\$ 1,450.00
25250F	Planner Studio 48x72 Table	36" Fixed-Height w/casters	48	72	36	70		191	\$ 1,475.00
25251F	Planner Studio 48x72 Table	36" Fixed-Height w/glides	48	72	36	70		191	\$ 1,475.00
25252F	Planner Studio 48x72 Table	40" Fixed-Height w/casters	48	72	40	70		195	\$ 1,500.00
25253F	Planner Studio 48x72 Table	40" Fixed-Height w/glides	48	72	40	70		195	\$ 1,500.00

Planner Studio Laminate Color Choice

- Pewter Mesh **PEW** w/matching 3mm edge
- Mission Maple **MIM** w/matching 3mm edge
- Whiteboard **FWB** * w/Grey [North Sea] 3mm edge

Planner Studio Leg Color Choice

- Apple **AP**
- Cerulean **CE**
- Charcoal **CG**
- Orange **OR**
- Platinum **PL**

Planner Studio Has THREE Top Color Options

- Choice 1 – Pewter Mesh top/matching 3mm edge
- Choice 2 – Mission Maple top/matching 3mm edge
- *Choice 3 – Whiteboard top/Grey "North Sea" 3mm edge

- * Whiteboard laminate top, add \$125 to list price.
- * Whiteboard laminate surface has a 1-year warranty.

Planner Studio Has ONE Top and Edge Profile

- F** 3mm Edge 1 1/4" top with 3mm flat edge. **F** to follow Model No.

Tables Planner® Studio



48" d x 48" w Planner Studio, Model 25239BUTCHER/PL
36" h, Shown in Butcher Block top and Charcoal legs with optional Foot Rails, Model 77244.

Planner Studio Tables – Butcher Block

The sturdy legs match the Planner Studio series and come in Studio's 5 colors. Meet the demanding needs of your Makerspace, without the pared down "shop-class" aesthetics.

- Strong, 14-gauge steel legs are protected with a durable powder coat surface.
- Sturdy 1 3/4" solid birchwood butcher block.
- Butcher Block Tables come in three sizes: 36"x72", 30"x60" or 48"x48" only.
- Butcher Block tops are a natural wood surface and each top is unique, no two are alike.

Model	Description	D"	W"	H"	F.C.	Cube	WT	List Price
36"x72" Butcher Block Models								
25212BUTCHER/_ _	Planner Studio 36x72	29" Fixed-Height w/casters	36	72	29	70	174	\$ 1,745.00
25213BUTCHER/_ _	Planner Studio 36x72	29" Fixed-Height w/glides	36	72	29	70	174	\$ 1,745.00
25214BUTCHER/_ _	Planner Studio 36x72	36" Fixed-Height w/casters	36	72	36	70	177	\$ 1,770.00
25215BUTCHER/_ _	Planner Studio 36x72	36" Fixed-Height w/glides	36	72	36	70	177	\$ 1,770.00
25216BUTCHER/_ _	Planner Studio 36x72	40" Fixed-Height w/casters	36	72	40	70	181	\$ 1,795.00
25217BUTCHER/_ _	Planner Studio 36x72	40" Fixed-Height w/glides	36	72	40	70	181	\$ 1,795.00
48" x 48" Butcher Block Models								
25236BUTCHER/_ _	Planner Studio 48x48	29" Fixed-Height w/casters	48	48	29	70	143	\$ 1,795.00
25237BUTCHER/_ _	Planner Studio 48x48	29" Fixed-Height w/glides	48	48	29	70	143	\$ 1,795.00
25238BUTCHER/_ _	Planner Studio 48x48	36" Fixed-Height w/casters	48	48	36	70	146	\$ 1,820.00
25239BUTCHER/_ _	Planner Studio 48x48	36" Fixed-Height w/glides	48	48	36	70	146	\$ 1,820.00
25240BUTCHER/_ _	Planner Studio 48x48	40" Fixed-Height w/casters	48	48	40	70	150	\$ 1,845.00
25241BUTCHER/_ _	Planner Studio 48x48	40" Fixed-Height w/glides	48	48	40	70	150	\$ 1,845.00

Planner Studio Leg Color Choice

- Apple AP
- Cerulean CE
- Charcoal CG
- Orange OR
- Platinum PL



**36" d x 72" w Planner Studio,
25212BUTCHER/CE**
29" h, Shown in Butcher Block top and
Cerulean legs with optional Oodle
stools in Cerulean and Charcoal..



**36" d x 72" w Planner Studio,
25214BUTCHER/CG**
36" h, Shown in Butcher Block top
and Charcoal legs with optional
Flavors 24" Fixed-Height Stools.

Tables Planner® Studio

A fresh addition
to Planner Studio.



30" d x 60" w Planner Studio,
Model 25256F
29" h, Shown in Mission Maple top with optional
Groove® Mobile Stack chairs in Mint.

Planner Studio Tables — 30" Deep

The Planner is ideal for all kinds of classroom activities. The new 30" depth allows for more intimate work spaces and adapts well with smaller classrooms. The heavy-duty construction contributes to a sturdy work surface that can hold 400 pounds. Planner Studio tables are shipped ready to assemble.

- Strong, 14-gauge steel legs are protected with a durable powder coat surface.
- 3mm flat edges.
- Sturdy 1 1/4" desktop with a high-pressure laminate surface.
- 3 top colors.

Model	Description		D"	W"	H"	F.C.	Cube	WT	List Price
25254F	Planner Studio 30x48	Adjustable-Height w/casters	30	48	29-40	70	3.0	95	\$ 999.00
25255F	Planner Studio 30x48	Adjustable-Height w/glides	30	48	29-40	70	3.0	99	\$ 999.00
25256F	Planner Studio 30x60	Adjustable-Height w/casters	30	60	29-40	70	3.8	107	\$1,099.00
25257F	Planner Studio 30x60	Adjustable-Height w/glides	30	60	29-40	70	3.8	111	\$1,099.00
25258F	Planner Studio 30x72	Adjustable-Height w/casters	30	72	29-40	70	4.5	119	\$1,199.00
25259F	Planner Studio 30x72	Adjustable Height w/glides	30	72	29-40	70	4.5	122	\$1,199.00
Foot Rests (for 30" d Planner Studio Tables, Platinum only - Foot Rests not compatible with Low Range Inserts.)									
70004	(x1) 48" w Planner Studio Foot Rest					70		19	\$ 179.00
70005	(x1) 60" w Planner Studio Foot Rest					70		21	\$ 179.00
70006	(x1) 72" w Planner Studio Foot Rest					70		26	\$ 179.00

Planner Studio Laminate Color Choice

- Pewter Mesh **PEW**
w/matching 3mm edge
- Mission Maple **MIM**
w/matching 3mm edge
- Whiteboard **FWB** *
w/Grey [North Sea] 3mm edge

Planner Studio Leg Color Choice - 30" Deep Tables Platinum Frame Only

- Platinum **PL**

Planner Studio Has THREE Top Color Options

- Choice 1 – Pewter Mesh top/matching 3mm edge
- Choice 2 – Mission Maple top/matching 3mm edge
- *Choice 3 – Whiteboard top/Grey "North Sea" 3mm edge

* Whiteboard laminate top, add \$125 to list price.

* Whiteboard laminate surface has a 1-year warranty.

Planner Studio Has ONE Top and Edge Profile

- F** 1 1/4" top with 3mm flat edge.
F to follow Model No.

*Standard 3/8" bumper edges available,
no letter to follow Model No.



**Optional Low Range
Leg Available (21-29")**

See Price List for Models & Prices



30"d x 60"w Planner Studio, Model 25256BUTCHER
 36"h, Shown in Butcher Block top and Platinum legs, optional Footrest, Model 70005 and optional Power Strip, Model 77248.



Groove Stools
 24"h and 30"h Groove stools stack neatly and can be stored when students prefer to stand.

Planner Studio Tables — 30" Deep – Butcher Block

The Planner is ideal for all kinds of classroom activities. The new 30" depth allows for more intimate work spaces and adapts well with smaller classrooms. The heavy-duty construction contributes to a sturdy work surface that can hold 400 pounds. Planner Studio tables are shipped ready to assemble.

- Strong, 14-gauge steel legs are protected with a durable powder coat surface.
- Sturdy 1 3/4" solid birchwood butcher block.
- 3mm flat edges.

Model	Description		D"	W"	H"	F.C.	Cube	WT	List Price
25256BUTCHER	Planner Studio 30x60	Adjustable-Height w/casters	30	60	29-40	70	3.8	115	\$1,595.00
25257BUTCHER	Planner Studio 30x60	Adjustable-Height w/glides	30	60	29-40	70	3.8	119	\$1,595.00

Tables Planner® Studio



Model 25270F PEW/CE
12" x 46" Planner Bench paired with
Model 25230F PEW/CE
36"d x 60"w x 29"h, both Shown in Pewter Mesh
top with matching 3mm edge and Cerulean legs.



Planner Studio – Bench

The sturdy legs match the Planner Studio series and come in Studio's 5 colors. Meet the demanding needs of your Makerspace, without the pared down "shop-class" aesthetics. The 46" Wide benches are made to pair with 60" Planner Studio Tables, while the 58" Wide benches are made to pair with 72" Planner Studio Tables.

- Strong, 14-gauge steel legs are protected with a durable powder coat surface.
- Available in double or single sided bench configurations.
- Sturdy 1 1/4" thick seating surface with a high-pressure laminate OR 1 3/4" butcher block.
- Legs available in 5 color choices.



Model 25271F MIM/PL
12x58 Single Bench.
Shown in Mission Maple top with matching 3mm edge and Platinum legs.



Model 25273F MIM/PL
24.5x58 Double Bench.
Shown in Mission Maple top with matching 3mm edge and Platinum legs.

Model	Description	D"	W"	H"	F.C.	Cube	WT	List Price
Single Benches 12" Deep								
25270F	12x46 Single Bench	17	46	18	70		50	\$ 549.00
25270BUTCHER	12x46 Single Bench (Butcher Block)	17	46	18	70		55	\$ 649.00
25271F	12x58 Single Bench	17	58	18	70		59	\$ 649.00
25271BUTCHER	12x58 Single Bench (Butcher Block)	17	58	18	70		66	\$ 749.00
Double Benches 24.5" Deep								
25272F	24.5x46 Double Bench	25.5	46	18	70		83	\$ 849.00
25272BUTCHER	24.5x46 Double Bench (Butcher Block)	25.5	46	18	70		93	\$ 949.00
25273F	24.5x58 Double Bench	25.5	58	18	70		101	\$ 949.00
25273BUTCHER	24.5x58 Double Bench (Butcher Block)	25.5	58	18	70		115	\$ 1049.00

Planner Studio Laminate Color Choice

- Pewter Mesh **PEW** w/matching 3mm edge
- Mission Maple **MIM** w/matching 3mm edge
- Butcher Block **BUTCHER*** 1 3/4" birchwood

Planner Studio Leg Color Choice

- Apple **AP**
- Cerulean **CE**
- Charcoal **CG**
- Orange **OR**
- Platinum **PL**

Planner Studio Bench Has TWO Top Options

F 3mm Edge 1 1/4" top with 3mm flat edge.
F to follow Model No.

BUTCHER 1 3/4" birchwood.
BUTCHER to follow Model No.

This all-new whiteboard puts messages in motion.

29" h



Planner Studio Mobile Whiteboard, Model 25260 Apple (AP)
Shown in Apple.

Planner Studio – Mobile Whiteboard

The Planner Studio Whiteboard perfectly complements our Planner Studio line of tables to create a unique and creative environment for today's learners. It provides a sophisticated looking two-sided laminated writing surface and includes a small shelf located on both sides to hold markers and erasers. The unit is available in 5 frame colors; Apple, Cerulean, Orange, Platinum and Charcoal. 4 locking casters provide mobility.

Model	Description	D"	W"	H"	F.C.	Cube	WT	List Price
25260	Planner Studio Mobile Whiteboard 29" Fixed-Height w/casters	26	42	72	70		105	\$ 999.00

Planner Studio Leg Color Choice

● Apple AP ● Cerulean CE ● Charcoal CG ● Orange OR ● Platinum PL



Huddle-6 Student Desk, Model 01265
Shown with optional Steel Bookbox, Model 17015. Optional 17576 Casters.

Huddle® Student Desk

This compact collaborative learning desk offers maximum strength and stability. Its size allows more students to fit in a classroom and its trapezoid desktop enables compact circles to be created for group work. Features handy backpack peg. Choose from 14 standard laminate colors, 20 standard edge band and two leg colors. See size choices, below.

- Patented backpack peg that keeps student items organized, can be positioned inside or outside of either leg.
- Adjustable desk height, from 22"-32" in 1" increments.
- Durable desktop available in 1 1/4" or 3/4" thickness, all with a high-pressure laminate surface.
- Steel front panel adds stability.
- "H" Frame construction adds strength.
- Rugged powder coat surface on legs resists wear.
- Leg sets don't shimmy or rock.

Model	Description	D"	W"	H"	F.C.	Cube	Wt.	UPS	List Price
01265	6' Huddle Desk, Circle, 6-Student	18	30	22-32	70	1.1	35	*	\$ 233.00
01266	7' Huddle Desk, Circle, 8-Student	18	31	22-32	70	1.1	36	*	\$ 237.00
01267	Huddle-8LS	24	31	22-32	70	1.4	42	*	\$ 251.00

Smith System recommends the Huddle-6 and Huddle-8 for grades K-5; Huddle-8LS for upper grades.

Huddle Bookbox

17015	Bookbox for Huddle-6 Desk #01265 – 6" w back	15	21	3.5	70	0.5	6	*	\$ 65.00
17016	Bookbox for Huddle-8 Desk #01266 & 01267 – 10" w back	15	21	3.5	70	0.5	6	*	\$ 65.00

Bookboxes available in Black and Platinum.

30925	SW (Standard Width) Tote Tray w/housing	16.8	13.5	3	70	1.13	8	*	\$ 93.00
-------	---	------	------	---	----	------	---	---	----------

Cascade SW tote works on Model 01267 only.



Huddle-6 Student Desk

Model 01265. Shown in High Rise Oak top with Cerulean Blue edge and Platinum frame. Shown with optional Groove® Mobile Chairs, see page 40.



Patented backpack peg keeps student items organized, can be positioned inside or outside of either leg.

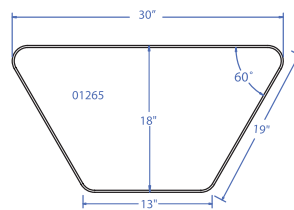

Huddle-6 (top down view)
Model #01265

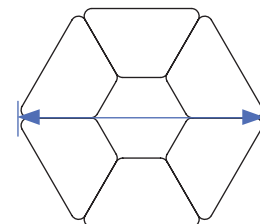

Configuration of Huddle-6
Desks is 63.8" in diameter.



Huddle-8 Student Desk
Model 01266. Shown in Boardwalk Oak top with Platinum edge and Platinum frame.
 Optional Steel Bookbox, Model 17016.
 Optional 17576 Casters.



Bow-Tie



Half-Circle



Full-Circle

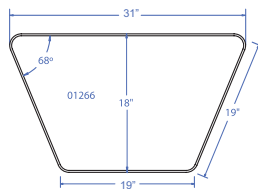

Huddle-8 (top down view)
 Model #01266

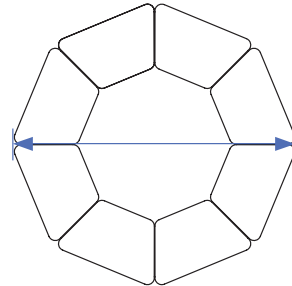

This configuration of Huddle-8
 Desks is 84.3" in diameter.
 Model #01266

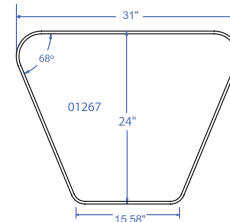

Huddle-8LS (top down view)
 Model #01267

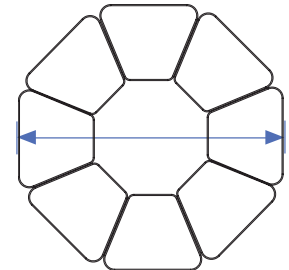

This configuration of Huddle-8LS
 Desks is 86.83" in diameter.
 Model #01267

Planner Huddle Have Top and Edge Choices



CHOICE 1 – 1 1/4" top with Bumper T-Mold no letter to follow Model No.



CHOICE 2 – 1 1/4" top with 4mm T-Mold **D** to follow Model No.



CHOICE 3 – 3/4" top with 4mm T-Mold **C** to follow Model No.

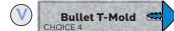

CHOICE 4 – 3/4" top with Bullet T-Mold **V** to follow Model No.



Make it mobile.
 Order Model 17576
 \$ 76.00 List

Planner Huddle Desk Laminate Color Choice

- Asian Night
- Classic Linen
- Palisades Oak
- New Age Oak
- Grey Nebula
- Boardwalk Oak
- High Rise
- Flax Linen
- Wild Cherry
- French Pear
- Pewter Mesh
- Buka Bark
- Mission Maple
- Fusion Maple

Leg Color Choice

- Black
- Platinum

Planner Huddle Desk Edge Color Choice

- Apple
- Burgundy
- Charcoal
- Forest Green
- Mocha
- Persian Blue
- Red
- Black
- Cerulean
- Chocolate
- Fuchsia
- Navy
- Platinum
- Yellow
- Blueberry
- Champagne
- Clementine
- Mint
- Orange
- Purple

View all finish options on page 271.





Model 01272C

Shown in Boardwalk Oak top with Orange edge and Platinum frame. Shown with optional Groove® Mobile Chair, Model 33855.

Planner Single-Student Desk

This spacious desk offers maximum strength and stability and is best suited for traditional classrooms. Features handy backpack peg. Choose from 14 standard laminate colors, and 20 standard edge colors.

- Patented backpack peg that keeps student items organized can be positioned inside or outside of either leg.
- Adjustable desk height, from 22"-32" in 1" increments.
- Durable desktop available in 1 1/4" or 3/4" thickness, all with a high pressure laminate surface.
- Edge moldings resist wear, choices available (see chart).
- Steel front panel adds stability.
- Rugged powder coat surface on legs resists wear.

Model	Description	D"	W"	H"	F.C.	Cube	Wt.	UPS	List Price
20" Deep Models									
01272	Planner Student Desk Single-Student	20	27	22-32	70	1.0	36	*	\$ 226.00
01274	Planner Student Desk Single-Student	20	36	22-32	70	1.4	42	*	\$ 260.00
01279	Planner Student Desk Single-Student	20	32	22-32	70	1.8	40	*	\$ 242.00
24" Deep Models									
01285	Planner Student Desk Single-Student	24	27	22-32	70	1.3	42	*	\$ 252.00
01286	Planner Student Desk Single-Student	24	36	22-32	70	1.8	50	*	\$ 278.00



Model 01272C

Shown in Boardwalk Oak top with Orange edge and Platinum frame. Shown with optional Groove Mobile Chair, Model 33855.



Model 01272C

Shown in Asian Night top with Mint edge and Platinum frame. Shown with optional Wire Book Basket, Model 17200.

Dimension Chart

Model	A	B	C	D
01272	20"	15.25"	27"	21"
01274	20"	15.25"	36"	30"
01279	20"	15.25"	32"	26"
01285	24"	19.25"	27"	21"
01286	24"	19.25"	36"	30"

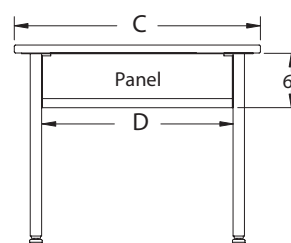
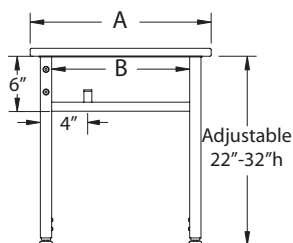



Model 01290

Shown in Grey Nebula top with Navy edge and Black frame. Shown with two optional Steel Bookboxes, Model 17190.

Planner Two-Student Desk

This desk offers maximum strength and stability while providing ample workspace for two students. Features handy backpack peg. Choose from 14 standard laminate colors, and 20 standard edge colors.

Model	Description	D"	W"	H"	F.C.	Cube	Wt.	UPS	List Price
20" Deep Models									
01276	Planner Student Desk Two-Student	20	48	22-32	70	1.8	50	*	\$ 292.00
01278	Planner Student Desk Two-Student	20	54	22-32	70	2.0	54		\$ 307.00
01280	Planner Student Desk Two-Student	20	60	22-32	70	2.2	75		\$ 323.00
01284	Planner Student Desk Two-Student	20	72	22-32	70	2.5	89		\$ 362.00
24" Deep Models									
01287	Planner Student Desk Two-Student	24	48	22-32	70	2.2	61		\$ 312.00
01288	Planner Student Desk Two-Student	24	54	22-32	70	2.4	67		\$ 342.00
01289	Planner Student Desk Two-Student	24	60	22-32	70	2.7	84		\$ 383.00
01290	Planner Student Desk Two-Student	24	72	22-32	70	3.1	98		\$ 426.00

Dimension Chart

Model	A	B	C	D
01276	20"	15.25"	48"	42"
01278	20"	15.25"	54"	48"
01280	20"	15.25"	60"	54"
01284	20"	15.25"	72"	66"
01287	24"	19.25"	48"	42"
01288	24"	19.25"	54"	48"
01289	24"	19.25"	60"	54"
01290	24"	19.25"	72"	66"

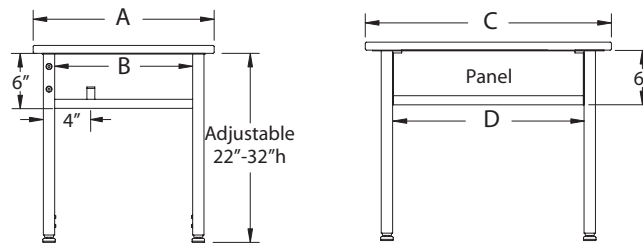

Planner Desks Have Top and Edge Choices

- 1 1/4" Tops**
- CHOICE 1** – 1 1/4" top with Bumper T-Mold no letter to follow Model No.
- CHOICE 2** – 1 1/4" top with 4mm T-Mold **D** to follow Model No.
- 3/4" Tops**
- CHOICE 3** – 3/4" top with 4mm T-Mold **C** to follow Model No.
- CHOICE 4** – 3/4" top with Bullet T-Mold **V** to follow Model No.



Two-Student Planner Desk, Model 01289

Shown in Flax Linen top with Black edge and Black frame.

Planner Desk Laminate Color Choice

- Asian Night
- Classic Linen
- Palisades Oak
- New Age Oak
- Grey Nebula
- Black
- Boardwalk Oak
- High Rise
- Flax Linen
- Wild Cherry
- French Pear
- Platinum
- Pewter Mesh
- Buka Bark
- Mission Maple
- Fusion Maple

Leg Color Choice

- Black
- Platinum

Planner Desk Edge Color Choice

- Apple
- Burgundy
- Charcoal
- Forest Green
- Mocha
- Persian Blue
- Red
- Black
- Cerulean
- Chocolate
- Fuchsia
- Navy
- Platinum
- Yellow
- Blueberry
- Champagne
- Clementine
- Mint
- Orange
- Purple

View all finish options on page 271.



Planner Single-Student Desks with Inzit Stack Chairs in the classroom.



20" deep Planner Three-Student Desk, Model 01295

Shown in Classic Linen top with Persian Blue edge and Platinum frame. Shown with optional Flavors Chairs in Persian Blue.

Planner® Three-Student Desk

This spacious desk offers maximum strength and stability for three students and is best suited for traditional classrooms. Features handy backpack pegs. Choose from 14 standard laminate colors and 20 standard edge colors.

- Patented backpack peg that keeps student items organized can be positioned inside or outside either leg.
- Adjustable desk height, from 22"-32" in 1" increments.
- Durable desktop available in 1 1/4" only, with high-pressure laminate surface.
- Edge moldings resist wear, choices available (see chart).
- Steel front panel adds stability.
- Rugged powder coat surface on legs

Model	Description	D"	W"	H"	F.C.	Cube	Wt.	UPS	List Price
20" Deep Models									
01295	Planner Student Desk	Three-Student	20	84	22-32	70	2.9	86	\$ 417.00
24" Deep Models									
01296	Planner Student Desk	Three-Student	24	84	22-32	70	2.9	98	\$ 482.00

Planner Three-Student Desk Has Top and Edge Choices

1 1/4" Tops



CHOICE 1 –
1 1/4" top with Bumper T-Mold
no letter to follow Model No.

1 1/4" Tops



CHOICE 2 –
1 1/4" top with 4mm T-Mold
D to follow Model No.



Planner Desk Laminate Color Choice

- | | | | | |
|-----------------|-----------------|-----------------|----------------|---------------|
| ● Asian Night | ● Classic Linen | ● Palisades Oak | ● New Age Oak | ● Grey Nebula |
| ● Boardwalk Oak | ● High Rise | ● Flax Linen | ● Wild Cherry | ● French Pear |
| ● Pewter Mesh | ● Buka Bark | ● Mission Maple | ● Fusion Maple | |

Leg Color Choice

- Black
- Platinum

Planner Desk Edge Color Choice

- | | | | | | | |
|-------------|-------------|--------------|----------------|----------|----------------|----------|
| ● Apple | ● Burgundy | ● Charcoal | ● Forest Green | ● Mocha | ● Persian Blue | ● Red |
| ● Black | ● Cerulean | ● Chocolate | ● Fuchsia | ● Navy | ● Platinum | ● Yellow |
| ● Blueberry | ● Champagne | ● Clementine | ● Mint | ● Orange | ● Purple | |

View all finish options on page 271.



Cascade® Storage

The 3" EW totes can be used under select desks; Silhouette®, Planner, and Arc™.

Planner Student Desk, Model 01272V
shown with optional Tote Tray with Housing Model 30926



Tote Trays

Translucent tote trays interface with Cascade Storage Units that hold totes.

- EW and SW totes work on 20 x 27 rectangles and larger.
- SW tote works with Huddle-8 LS Desk, Model 01267.

Cascade Tote Compatibility

Desks	SW	EW
Planner Student	✓	✓
Planner Two-Student	✓	✓
Planner Three-Student	✓	✓
Huddle® - 8 LS	✓	✗
Huddle - 6	✗	✗
Huddle - 8	✗	✗

Model	Description		D"	W"	H"	F.C.	Cube	WT.	UPS	List Price
30926	EW (Extra Wide) Tote Tray	w/housing	16.8	19.6	3	70	1.13	10	*	\$ 103.00
30925	SW (Standard Width) Tote Tray*	w/housing	16.8	13.5	3	70	1.13	8	*	\$ 93.00

*Use with 01267 Huddle Desk.



Steel Bookbox

Durable Steel Bookbox in rugged Black or Platinum powder coat finish.



Wire Book Basket

Wire Book Basket in rugged Black powder coat finish.



Technology Basket

Wire basket for small electronics or books.

Model	Description	D"	W"	H"	F.C.	Cube	WT.	UPS	List Price
17190	Steel Bookbox	15	20	4	70	3.0	8	*	\$ 61.00
17200	Wire Book Basket	15	18	3.5	70	3.0	5	*	\$ 51.00
17018	Technology basket	13	10	2	70	3.0	1	*	\$ 59.00



Casters

Add easy mobility to Planner Student Desks with these casters.

Model	Description	D"	W"	H"	F.C.	Cube	WT.	UPS	List Price
17576	3" Dual-Wheel Caster Set of 4, 4 locking. BLACK.	3" dia.		3"	70	0.1	5	*	\$ 76.00
17577 ___	3" Dual-Wheel Caster Set of 4, 4 locking. COLOR*	3" dia.		3"	70	0.1	5	*	\$ 96.00

*Model 17577 comes in your choice of Apple *APL*, Cerulean *CER*, Charcoal *CGR*, Orange *ORG* or Platinum *PLT*.



**36" deep Rectangle Planner
Activity Table, Model 25570L**

Shown in Fusion Maple with Purple edge and Platinum frame, low range legs. Shown with optional Flavors Stack Chairs, Model 11845 in Purple, Chocolate and Cerulean.



Model 25980V

20"d x 72"w. Shown in New Age Oak top with Apple edge and Platinum frame.



Model 25830

24"d x 72"w. Shown in non-standard Grey Mesh top with Blueberry edge and Platinum frame.



Model 25520

30"d x 60"w. Shown in Flax Linen top with Cerulean edge and platinum frame equipped with 3" casters, Model 17576.



Model 25700

42"d x 60"w. Shown in Fusion Maple top with Charcoal edge and Platinum frame.

Planner Rectangle Activity Tables

This table offers maximum strength and stability for a wide variety of classroom uses. Three height ranges available allow you to fit the table to the grade range of the student. Choose from 14 standard laminate colors, 20 standard edge colors and two leg colors (Black and Platinum).

- High-pressure laminate surface resists wear.
- Choose from several edge treatments.
- Table height adjusts 24" to 34" in 1" increments, meets ADA requirements.
- 1" adjustable leveling glides provide stability on uneven floors.

Structural Framing



20", 24", 30" & 36" deep Models

Center support channel is 2" by 3" wide of 14-gauge steel, with 11-gauge steel endplates for maximum stability.

Structural Framing



42" & 48" deep Models

Two 2" x 3" 14-gauge steel support channels with 11-gauge steel endplates provide maximum stability.



*Please note: When ordering a power unit (p. 252), it cannot be placed in the center of 20" deep, 24" deep, 30" deep or 36" deep models.

Model	Description		D"	W"	H"	F.C.	Cube	WT.	UPS	List Price
20" Deep Models										
25950	Planner Activity Table	Rectangle	20	36	24-34	70	1.7	58	*	\$ 333.00
25960	Planner Activity Table	Rectangle	20	48	24-34	70	2.2	64	*	\$ 380.00
25970	Planner Activity Table	Rectangle	20	60	24-34	70	2.8	73		\$ 430.00
25980	Planner Activity Table	Rectangle	20	72	24-34	70	3.3	86		\$ 481.00
25990	Planner Activity Table	Rectangle	20	90	24-34	70	4.2	108		\$ 516.00
24" Deep Models										
25800	Planner Activity Table	Rectangle	24	36	24-34	70	2.0	60	*	\$ 367.00
25810	Planner Activity Table	Rectangle	24	48	24-34	70	2.6	69	*	\$ 411.00
25820	Planner Activity Table	Rectangle	24	60	24-34	70	3.3	76		\$ 463.00
25830	Planner Activity Table	Rectangle	24	72	24-34	70	4.0	105		\$ 515.00
25840	Planner Activity Table	Rectangle	24	90	24-34	70	5.0	122		\$ 568.00
30" Deep Models										
25500	Planner Activity Table	Rectangle	30	36	24-34	70	2.5	76	*	\$ 447.00
25510	Planner Activity Table	Rectangle	30	48	24-34	70	3.0	90	*	\$ 466.00
25520	Planner Activity Table	Rectangle	30	60	24-34	70	3.8	104		\$ 518.00
25530	Planner Activity Table	Rectangle	30	72	24-34	70	4.5	120		\$ 572.00
25540	Planner Activity Table	Rectangle	30	90	24-34	70	6.3	137		\$ 667.00
36" Deep Models										
25550	Planner Activity Table	Rectangle	36	48	24-34	70	3.6	102		\$ 545.00
25560	Planner Activity Table	Rectangle	36	60	24-34	70	4.5	118		\$ 565.00
25570	Planner Activity Table	Rectangle	36	72	24-34	70	5.4	135		\$ 612.00
25580	Planner Activity Table	Rectangle	36	90	24-34	70	6.8	158		\$ 718.00
42" Deep Models										
25590	Planner Activity Table	Rectangle	42	90	24-34	70	8.75	195		\$ 892.00
25700	Planner Activity Table	Rectangle	42	60	24-34	70	5.8	143		\$ 694.00
25710	Planner Activity Table	Rectangle	42	72	24-34	70	7.0	163		\$ 763.00
48" Deep Models										
25720	Planner Activity Table	Rectangle	48	60	24-34	70	6.7	159		\$ 754.00
25730	Planner Activity Table	Rectangle	48	72	24-34	70	8.0	181		\$ 835.00
25740	Planner Activity Table	Rectangle	48	90	24-34	70	10.0	215		\$ 972.00

Optional Legs for Planner Activity (do not fit 42" or 48" depth tables).

• Low range available in 15-24"h. Add **L** following model number. Available in Black and Platinum frame only. Longer lead time applies.

Optional Legs for 30" and 36" Deep Models:

• Fixed height leg available in 29.5"h. Add **X** following model number. Available in Black only. Longer lead time applies.

Planner Activity Tables Have Top and Edge Choices

1 1/4" Tops

CHOICE 1 – 1 1/4" top with Bumper T-Mold
no letter to follow Model No.

CHOICE 2 – 1 1/4" top with 4mm T-Mold
D to follow Model No.

3/4" Tops

CHOICE 3 – 3/4" top with 4mm T-Mold
C to follow Model No.

CHOICE 4 – 3/4" top with Bullet T-Mold
V to follow Model No.

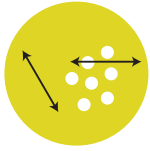

Planner Trapezoid Activity Table

Model 25600

Shown in non-standard Golden Oak top with Black edge and Black frame.



Planner Square Activity Table

Model 25610

Shown in Wild Cherry top with Black edge and Black frame.



Planner Half Moon Activity Table

Model 25650

Shown in non-standard Grey Mesh top with Persian Blue edge and Platinum frame.



Planner Round Activity Table

Model 25620

Shown in Asian Night top with Black edge and Platinum frame equipped with 3" casters, Model 17576.



Planner Contour Activity Table

Model 25660

Shown in non-standard Tan Echo top with Mint edge and Platinum frame.

Planner Activity Table

This table offers maximum strength and stability for a wide variety of classroom uses. Three height ranges available allow you to fit the table to the grade range of the student. Choose from 14 standard laminate colors, 20 standard edge colors and two leg colors.

- High-pressure laminate surface resists wear.
- Choose from several edge treatments.
- Table height adjusts 24" to 34" in 1" increments, meets ADA requirements.
- 1" adjustable leveling glides provide stability on uneven floors.
- Low range available in 15-24"h. Add **L** following model number. Longer lead time may apply. (not for 42" or 48" depths).
- Fixed height leg available in 29.5"h. Add **X** following model number. Available in Black only. (30" & 36" depths).

*Please note: When ordering a power unit (p. 190), it cannot be placed in the center of these tables.

Model	Description		D"	W"	H"	F.C.	Cube	WT.	UPS	List Price
25600	Planner Activity Table	Trapezoid	30	60	24-34	70	3.8	90		\$ 506.00
25610	Planner Activity Table	Square	48	48	24-34	70	4.8	133		\$ 640.00
25620	Planner Activity Table	Round	42"dia.		24-34	70	3.7	86		\$ 537.00
25630	Planner Activity Table	Round	48"dia.		24-34	70	4.8	98		\$ 582.00
25640	Planner Activity Table	Round	60"dia.		24-34	70	7.5	148		\$ 778.00
25650	Planner Activity Table	Half Moon	36	72	24-34	70	5.25	102		\$ 609.00
25660	Planner Activity Table	Contour	36	72	24-34	70	5.25	128		\$ 620.00
Not Shown										
25665	Planner Activity Table	Kidney	48	72	24-34	70	7.0	149		\$ 831.00
25645	Planner Activity Table	Flower	60"dia.		24-34	70	7.5	148		\$ 778.00

Planner Activity Tables Have Top and Edge Choices

- 1 1/4" Tops**
- CHOICE 1** – 1 1/4" top with Bumper T-Mold
no letter to follow Model No.
- CHOICE 2** – 1 1/4" top with 4mm T-Mold
D to follow Model No.
- 3/4" Tops**
- CHOICE 3** – 3/4" top with 4mm T-Mold
C to follow Model No.
- CHOICE 4** – 3/4" top with Bullet T-Mold
V to follow Model No.



Make it mobile.
Order Model 17576
\$ 76.00 List



Planner Activity Laminate Color Choice

Planner Activity Laminate Color Choice					Leg Color Choice	
● Asian Night	● Classic Linen	● Palisades Oak	● New Age Oak	● Grey Nebula	● Black	
● Boardwalk Oak	● High Rise	● Flax Linen	● Wild Cherry	● French Pear	● Platinum	
● Pewter Mesh	● Buka Bark	● Mission Maple	● Fusion Maple			

Planner Activity Edge Color Choice

● Apple	● Burgundy	● Charcoal	● Forest Green	● Mocha	● Persian Blue	● Red
● Black	● Cerulean	● Chocolate	● Fuchsia	● Navy	● Platinum	● Yellow
● Blueberry	● Champagne	● Clementine	● Mint	● Orange	● Purple	

View all finish options on page 271.



Choose a durable high-pressure laminate top or Trespa TopLab Plus top that offers excellent chemical resistance.

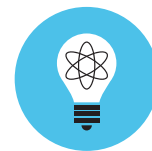

Planner 30x60 Butcher Block Table

Model 25521
30x60 Planner Butcher Block table.

This sturdy, 1 3/4" thick birchwood top provides solid functionality and a contemporary design aesthetic for science, art and maker environments. The table provides ample space for projects of all kinds.

- Supports up to 400 lbs.
- Table height adjusts 24" to 34" in 1" increments, meets ADA requirements.
- 1" adjustable leveling glides provide stability on uneven floors.
- Color choices: Platinum or Black frame.

Model	Description	D"	W"	H"	F.C.	Cube	Wt.	UPS	List Price
25521	Planner Butcher Block Table	30	60	24-34	70		112		\$ 1013.00



Model 11266

Shown in Graphite Nebula top with Black edge and Black frame.

Planner Science Table with Laminate Top

1 1/4" thick with vinyl edge band. Graphite Nebula laminate top with Black edge. Choose Black or Platinum frame.

- Supports up to 400 lbs.
- Table height adjusts 24" to 34" in 1" increments, meets ADA requirements.
- 1" adjustable leveling glides provide stability on uneven floors.

Model	Description	D"	W"	H"	F.C.	Cube	Wt.	UPS	List Price
11260	Planner Science Table Laminate Top	24	48	24-34	70	2.3	85		\$ 447.00
11263	Planner Science Table Laminate Top	24	54	24-34	70	2.6	90		\$ 471.00
11266	Planner Science Table Laminate Top	24	60	24-34	70	2.9	95		\$ 496.00
11269	Planner Science Table Laminate Top	24	72	24-34	70	3.5	110		\$ 548.00

Graphite Nebula is available in these sizes only at no upcharge. If over 20 are ordered on other models the upcharge will be waived.



Model 25705

Shown in Black Trespa TopLab Plus and Platinum frame. Shown with optional Groove® Adjustable Chairs, Model 33840.

Trespa® TopLab® Plus Planner Science Table

This sturdy, contemporary science table provides sleek looks and solid functionality. Its Trespa TopLab Plus work surface is designed for maximum durability. It is resistant to a large number of aggressive chemicals (as identified by SEFA and PSI) if cleaned within 24 hours. The table provides ample space for projects of all kinds.

- Supports up to 400 lbs.
- Table height adjusts 24" to 34" in 1" increments, meets ADA requirements.
- 1" adjustable leveling glides provide stability on uneven floors.
- Color Choices: Black top color only; Platinum or Black frame.



Model	Description	D"	W"	H"	F.C.	Cube	Wt.	UPS	List Price
24" Deep Models									
11262	Trespa TopLab Plus Planner Science Table	24	48	24-34	70	2.3	112		\$ 1,163.00
11265	Trespa TopLab Plus Planner Science Table	24	54	24-34	70	2.6	122		\$ 1,296.00
11268	Trespa TopLab Plus Planner Science Table	24	60	24-34	70	2.9	130		\$ 1,395.00
11271	Trespa TopLab Plus Planner Science Table	24	72	24-34	70	3.5	152		\$ 1,628.00
30" Deep Models									
11288	Trespa TopLab Plus Planner Science Table	30	60	24-34	70	3.5	152		\$ 1,628.00
42" Deep Models									
25705	Trespa TopLab Plus Planner Science Table	42	60	24-34	70	5.0	180		\$ 2,246.00
25715	Trespa TopLab Plus Planner Science Table	42	72	24-34	70	6.0	202		\$ 2,618.00
48" Deep Models									
25725	Trespa TopLab Plus Planner Science Table	48	60	24-34	70	5.8	240		\$ 2,523.00
25735	Trespa TopLab Plus Planner Science Table	48	72	24-34	70	7.0	284		\$ 2,951.00



Make it mobile.
Order Model 17576 \$ 76.00 List

Trespa Color Choice	Frame Color Choice
● Black	● Platinum ● Black



Planner Lab Station

Provides maximum strength and stability. Keeps cables and wires tucked neatly away with an integral Wire Manager. Comes with handy backpack pegs. Choose from 14 standard laminate colors, 20 standard edge colors and two frame colors.

- Available in multiple lengths and widths, allowing you to create workstations for one, two and three students.
- 1 1/4" thick top with high pressure laminate surface and 3/8" thick bumper edge molding stapled every 8".
- Cord cutout at rear of work surface. 8" high x 3" deep Wire Manager of 16-gauge steel with cable ports.



Planner Lab Station, Model 24510.
Shown in Grey Nebula top with Black edge and Black frame. Shown with optional Flat Panel Monitor Mount, Model 17351.

Model	Description		D"	W"	H"	F.C.	Cube	Wt.	UPS	List Price
24" Deep Models										
24610	Planner Lab Station	One-Student	24	36	22-32	70	1.8	56	*	\$ 413.00
24500	Planner Lab Station	Two-Student	24	48	22-32	70	2.4	68	*	\$ 459.00
24510	Planner Lab Station	Two-Student	24	60	22-32	70	3.0	80		\$ 523.00
24520	Planner Lab Station	Two-Student	24	72	22-32	70	3.6	92		\$ 575.00
24620	Planner Lab Station	Three-Student	24	84	22-32	70	4.2	104		\$ 634.00
30" Deep Models										
24530	Planner Lab Station	One-Student	30	30	22-32	70	2.0	59	*	\$ 421.00
24630	Planner Lab Station	One-Student	30	36	22-32	70	2.5	65	*	\$ 460.00
24540	Planner Lab Station	Two-Student	30	48	22-32	70	3.0	80	*	\$ 495.00
24550	Planner Lab Station	Two-Student	30	60	22-32	70	3.8	95		\$ 573.00
24560	Planner Lab Station	Two-Student	30	72	22-32	70	4.5	110		\$ 635.00
24570	Planner Lab Station	Three-Student	30	84	22-32	70	5.5	125		\$ 696.00

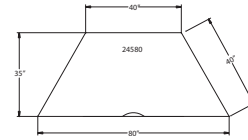

35" Deep Planner Work Center Top View



Shown with optional Flat Panel Mounts with Tilt, Model 17351 \$ 149.00

Planner Cluster Work Center

Provides maximum strength and stability. Its semi-hexagonal shape allows three students to work in a compact space against a wall. Or put two together for a compact six-student work group. Includes a cutout in the desktop and a Wire Manager. Choose from 14 standard laminate colors, 20 standard edge colors and two frame colors.

- 1 1/4" thick top with high-pressure laminate surface and 3/8" thick bumper edge.
- Adjustable table height from 22" up to 32" in 1" increments.
- Chrome-plated lower legs resist scuffing.
- Legs of 1 1/4" square, 12-gauge steel tubes with powder coat finish.
- 1" adjustable leveling glides provide stability on uneven floors.

Model	Description	D"	W"	H"	F.C.	Cube	Wt.	UPS	List Price
24580	Planner Cluster Work Center – Trap 40"x40"x40"x80"	35	80	22-32	70	5.4	125		\$ 769.00



Planner Lab, Corner Station

This maximizes space utilization by allowing students to work in a corner. It provides the strength and stability that Planner Labs are known for. Cutout in desktop helps manage cables while allowing a snug fit against both walls. Choose from 14 standard laminate colors, 20 standard edge colors and two frame colors.

Shown in Fusion Maple top with Black edge and Platinum frame.

Model	Description	D"	W"	H"	F.C.	Cube	Wt.	UPS	List Price
24600	Planner Lab, Corner Station – 6-Sided Corner	30	48	22-32	70	5.8	114		\$ 689.00

Access Station Planner®



Planner Access Station

Provides maximum strength and stability for computer work, plus great security for cables and wires thanks to a locking Wire Manager. Comes with handy backpack peg. Choose from 14 standard laminate colors, 20 standard edge colors and two frame colors.

- Chrome-plated lower legs resist scuffing.
- 1" adjustable leveling glides provide stability on uneven floors.
- Full-length locking 6" deep door has cord cutouts, providing easy access to wires.
- Adjustable table height from 22" up to 32" in 1" increments.
- Cord cutout at rear of work surface. 8" high x 3" deep Wire Manager of 16-gauge steel with cable ports.

Model	Description		D"	W"	H"	F.C.	Cube	Wt.	UPS	List Price
24" Deep Models										
11140	Planner Access Station	Single-Student	24	30	22-32	70	3.5	56	*	\$ 502.00
11141	Planner Access Station	Single-Student	24	36	22-32	70	4.25	63	*	\$ 540.00
11142	Planner Access Station	Single-Student	24	42	22-32	70	5.0	70		\$ 578.00
11143	Planner Access Station	Two-Student	24	48	22-32	70	5.7	76		\$ 604.00
11144	Planner Access Station	Two-Student	24	60	22-32	70	7.0	93		\$ 690.00
11145	Planner Access Station	Two-Student	24	72	22-32	70	8.5	110		\$ 771.00
11146	Planner Access Station	Three-Student	24	84	22-32	70	9.7	126		\$ 856.00
<i>*24" Deep Models will not accommodate Keyboard Trays.</i>										
30" Deep Models										
11160	Planner Access Station	Single-Student	30	30	22-32	70	4.4	72	*	\$ 532.00
11161	Planner Access Station	Single-Student	30	36	22-32	70	5.4	79	*	\$ 574.00
11162	Planner Access Station	Single-Student	30	42	22-32	70	6.2	86		\$ 617.00
11163	Planner Access Station	Two-Student	30	48	22-32	70	7.0	92		\$ 651.00
11164	Planner Access Station	Two-Student	30	60	22-32	70	9.3	109		\$ 746.00
11165	Planner Access Station	Two-Student	30	72	22-32	70	8.8	126		\$ 843.00
11166	Planner Access Station	Three-Student	30	84	22-32	70	12.0	142		\$ 942.00



Access Station, 5-Sided Corner

This maximizes space utilization while providing maximum strength and stability, plus great security for cables and wires thanks to a locking Wire Manager. Choose from 14 standard laminate colors, 20 standard edge colors and two frame colors. Not for use with casters.

Shown in non-standard Blond Echo top with Cerulean edge and Platinum frame.

Model	Description		D"	W"	H"	F.C.	Cube	Wt.	UPS	List Price
24" Deep Models										
11147	Access Station	5-Sided Corner	24	48	22-32	70	8.0	112		\$ 891.00
30" Deep Models										
11167	Access Station	5-Sided Corner	30	48	22-32	70	11.0	128		\$ 925.00



Model 11164

Shown in Classic Linen top with Navy edge and Platinum frame with optional 17576 casters.



Planner Access Station comes with lift-up door with key lock standard. Wire Manager keeps wires tucked away.



Accessories Planner®

Planner Activity Legsets



1. Standard Legset

- Adjustable from 24"-34", features 1" leveling glides to assure a steady table on uneven floors.
- Black and Platinum frame only.
- Accepts caster, Model 17576 or 17377.



2. High Leg Inserts

- For tables 30" and 36" deep and larger.
- Order special leg insert set for adjustment from 30¼" to 40¼" high.
- 4 pack.
- Accepts casters, Model 17576 or 17577.
- Model 17500, \$59.00 List.



3. Short Adjustable Legset

- Designed for Early Childhood use, this option allows height adjustability from 15"-24" in 1" increments.
- Features 1" leveling glides.
- Available on select Planner 24", 30" & 36" depth tables.
- Add **L** following model number.
- Black and Platinum frame only.
- Longer lead time may apply.



4. Fixed Height Legset

- Set at 29 1/2", features 1" leveling glides to assure a steady table on uneven floors.
- Available on select Planner models. 30" and 36" depths only.
- Black only.
- Add **X** following model number.
- Does not accept casters.
- Longer lead time may apply.



Planner Rectangle Modesty Panel

Designed to complement tables in the Interchange and Planner lines. Order it in any of 14 standard laminate colors, 20 edge colors.

Model	Description	D"	W"	H"	F.C.	Cube	WT.	UPS	List Price
Accessories									
17201	Planner Rectangle Modesty Panel for 36" w Table				70		18	*	\$ 102.00
17202	Planner Rectangle Modesty Panel for 48" w Table				70		24	*	\$ 119.00
17203	Planner Rectangle Modesty Panel for 60" w Table				70		30	*	\$ 135.00
17204	Planner Rectangle Modesty Panel for 72" w Table				70		36		\$ 154.00
17205	Planner Rectangle Modesty Panel for 90" w Table				70		44		\$ 187.00



Desktop Lectern

Its distinctive shape allows the instructor to reference two sources simultaneously and, thanks to its rugged steel construction, it can support a laptop. Mount to tabletop with either our Clamp-On or Bolt-On Mount.

Model	Description	D"	W"	H"	F.C.	Cube	WT.	UPS	List Price
Dual Surface Desktop Lectern									
00470	Desktop Lectern w/Swing Arm	Clamp-On	19	19	6	70	1.3	22	\$ 225.00
00471	Desktop Lectern w/Swing Arm	Bolt-On	19	19	6	70	1.3	25	\$ 225.00
00472	Desktop Lectern w/Spring Loaded Swing Arm	Clamp-On	19	19	6	70	1.3	23	\$ 250.00
Curl top Desktop Lectern									
00480	Desktop Lectern w/Swing Arm	Clamp-On	14.5	19	4	70	0.6	19	\$ 225.00
00481	Desktop Lectern w/Swing Arm	Bolt-On	14.5	19	4	70	0.6	22	\$ 225.00
00482	Desktop Lectern w/Spring Loaded Swing Arm	Clamp-On	14.5	19	4	70	0.6	20	\$ 250.00



Casters

Add easy mobility to Planner Student Desks and Planner Computer Stations with these casters. Choose a set of two for wheelbarrow mobility, or a set of four for level mobility.

Model	Description	D"	W"	H"	F.C.	Cube	WT.	UPS	List Price
17576	3" Dual-Wheel Caster Set of 4, 4 locking. BLACK.	3" dia.		3"	70	0.1	5	*	\$ 76.00
17577	3" Dual-Wheel Caster Set of 4, 4 locking. COLOR*	3" dia.		3"	70	0.1	5	*	\$ 96.00
* Model 17577 comes in your choice of Apple <i>APL</i> , Cerulean <i>CER</i> , Charcoal <i>CGR</i> , Orange <i>ORG</i> or Platinum <i>PLT</i> .									
17554	4" Dual-Wheel Caster Set of 4, 2 locking. BLACK.	4" dia.		4"	70	0.1	5	*	\$ 107.00
* Model 17554, not for wheelbarrowing.									



CPU Holder

Heavy steel plate mounts under work surface. Black steel tube frame with locks to hold tower in place.

Model	Description	D"	W"	H"	F.C.	Cube	WT.	UPS	List Price
Optional Accessories									
17213	CPU Holder	14 – 18.5	8.5 – 11.6	16.75 -21.25	70	0.5	12	*	\$ 159.00
	• PC Dimensions	9.75 – 17.5	5.4 – .6	15.25 – .75					
17217	CPU Holder	14 – 18.75	8.5 – 9.2	13 – 17.25	70	0.5	10	*	\$ 149.00
	• PC Dimensions	9.5 – 17.4	3 – 7.25	9.4 – 13.5					



Adjustable Keyboard Shelf

Features 6" height adjustment with 10° tilt and 180° swivel with easy single control. 11"d x 28"w steel tray has padded palm rest.

Model	Description	D"	W"	H"	F.C.	Cube	WT.	UPS	List Price
17620	Pull-out Keyboard	Adjustable Height	17	28	6	70	1.3	20	\$ 270.00
17622	Pull-out Keyboard	Adjustable Height	17	20	6	70	1.3	20	\$ 265.00
*24" deep Planner Access models will not accommodate Keyboard Trays.									



Flat Panel Mount Tilt and Swivel Model

Tilts, swivels and is height adjustable to optimize user ergonomics.

Model	Description	D"	W"	H"	F.C.	Cube	WT.	UPS	List Price
17351	Flat Panel Mount w/Tilt and Swivel	7	5	18	70	.09	6	*	\$ 149.00



Model 17081



Model 17084

Access Station Power Strips

Model	Description	D"	W"	H"	F.C.	Cube	WT.	UPS	List Price
17081	6 Outlet Electric Strip w/Surge, 4' Cord	3	3	12	70	0.1	4	*	\$ 65.00
17084	10 Outlet Electric Strip w/Surge, 15' Cord	3	8	12	70	0.1	5	*	\$ 152.00



This symbol indicates you can add power to select tables.



You will find the “ADD POWER” logo throughout this catalog. It signifies which Smith System tables are compatible with our power units.

When ordering, please submit a drawing with your order to indicate the desired positioning of the power unit on the work surface. All power accessories are special order, a custom feature per table and are non-returnable. For more information call 800.328.1061.



Flat Power Module

Shown, Model 017098 SLV
1 power, 1 Twin USB port

Model	Description	D"	W"	H"	UPS	List Price
017098 SLV	1 power, 1 Twin USB port				*	\$ 260.00
017097 SLV	2 power				*	\$ 175.00



Soft Touch Dome Power Module

Shown, Model 017079
BLA 2 power, 1 Twin USB port, 1 power cord

Model	Description	D"	W"	H"	UPS	List Price
017079 BLA	2 power, 1 Twin USB port				*	\$ 245.00
017078 BLA	3 power				*	\$ 160.00



Clamp-On Power Module

4 plug power outlet with 15 ft cord

Model	Description	D"	W"	H"	UPS	List Price
17107	4 power	2.8	6.6	3.3	*	\$ 375.00



Surface Power Module

Shown, Model 017093 SLV
4 power

Model	Description	D"	W"	H"	UPS	List Price
017093 SLV	4 power	3	8	.11	*	\$ 350.00
017086 SLV	2 power, 4 USB	3	8	.11	*	\$ 350.00



Retractable Power Module

Shown, Model 017085 SLV
2 power, 2 Twin USB ports

Model	Description	D"	W"	H"	UPS	List Price
017085 SLV	2 power, 4 USB	4.43	8.25	1.34	*	\$ 495.00
017092 SLV	4 power	4.43	8.25	1.34	*	\$ 495.00



Retractable Mini Power Module

2 power

Model	Description	D"	W"	H"	UPS	List Price
017091 SLV	2 power	3.7	3.7	1.17	*	\$ 250.00

Mounts for tables, desks and workstations.



Flat Panel Mount

Tilt & Swivel Model 17351
Tilts, swivels and is height adjustable to optimize user ergonomics.



Flat Panel Mount

Swing-Out Arm with Tilt & Swivel Model 17352
It can be tilted, swiveled, raised, lowered and moved closer to the user. Bolt-On model shown.



Flat Panel Mount

Swing-Out Arm with Tilt & Swivel Model 17353
It can be tilted, swiveled, raised, lowered and moved closer to the user. Clamp-On model shown.



Spring-Loaded Flat Mount

Spring-Loaded Mount Model 17655
It can be tilted, swiveled, raised, lowered and moved closer to the user. Spring loaded arm enables one-handed adjustments.

Model	Description		D"	W"	H"	F.C.	Cube	WT.	UPS	List Price
17351	Flat Panel Mount	Tilt & Swivel Model	7	5	18	70	0.9	6	*	\$ 149.00
17352	Flat Panel Mount Swing-out Arm (Bolt-On)	Tilt & Swivel Model	7	5	18	70	0.9	8	*	\$ 199.00
17353	Flat Panel Mount Swing-out Arm (Clamp-On)	Tilt & Swivel Model	7	6	20	70	1.1	11	*	\$ 199.00
17655	Flat Panel Mount	Spring Loaded Model	5	5	21	70	0.35	11	*	\$ 199.00



Deluxe Tabletop Lectern

High-pressure laminate top with retainer and large storage area for reference materials.

Top: Choose from our 14 laminate colors.

Edge: Choose from our 20 edge colors.

Base: Choose Black or Platinum.

Lecterns Have Top and Edge Choices

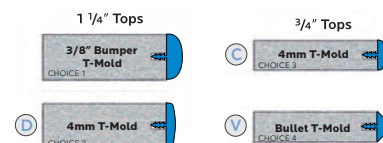

Model	Description	D"	W"	H"	F.C.	Cube	WT.	UPS	List Price
04619	Deluxe Tabletop Lectern	20	18	13	125	3.0	21		\$ 197.00



Platinum

Mobile Drawer Pedestal

Steel construction, drawers lock and have an interlock system that prevents accidental tipping caused by more than one drawer opening at a time. Full extension ball bearing slides allow full access to drawer contents. Black or Platinum. With 2" dual-wheel casters.

Model	Description	D"	W"	H"	F.C.	Cube	WT.	UPS	List Price
19172	Mobile Drawer Pedestal	File/File	22	15.5	27.5	100	5.7	50	\$ 359.00
19173	Mobile Drawer Pedestal	Box/Box/File	22	15.5	25.5	100	5.7	50	\$ 355.00



Pull-Out Knee Drawer

Store your essentials out of sight with this pull-out drawer for Acrobat Desks. Black molded drawer mounts under work surface. Molded pencil area 18"d. Drawer height 1.875"h. Inside width 20.5".

Model	Description	D"	W"	H"	F.C.	Cube	WT.	UPS	List Price
17342	Center Drawer for Acrobat	18	23	1.875	70	0.5	5	*	\$ 69.00

Tables Meeting

Collaboration
begins right here.





Round Café Table



Square Café Table



Multimedia Table



Multimedia Table



Oval Double Café Table



Racetrack Table



Peanut Table



Rectangular Table

More options for collaborative and distance learning.

From now on, students will be working together on all of their academic subjects. In some cases, they may work on two or more subjects at the same time. Additionally, more and more students are participating in “distance learning,” receiving lectures or instruction via video from teachers located away from the classroom.

These new methods for learning require new resources, created expressly to facilitate their instruction. The wide variety of Smith System meeting tables addresses both traditional and emerging needs (with special attention paid to connectivity) identified for classrooms, labs and commons areas.



Flat Surface Power Module
Model 017098
\$260.00 List



Soft Touch Dome
Model 017078
\$160.00 List

Round
01502
01504
01506
01507

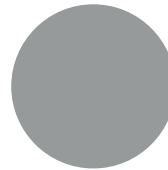

Square
01501
01503



Peanut
01520

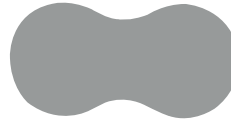

Rectangle
01524



Oval
01527



Racetrack
01522



48" x 60"
Multimedia
01531



42" x 72"
Multimedia
01555





Plan (Assignment 1)
Reference types
- comparison operator ==
- method calls
Object oriented programming

Handwritten notes on a whiteboard to the left, including a red arrow and some illegible text.



Café Tables Meeting

Plug in, recharge and collaborate.

Our Café tables are a popular choice for creating casual meeting areas in commons areas. Students can gather and collaborate in a more laid back atmosphere.



42" Round Café Table

Shown with 40"h, 30" Circular Base

Grey Mesh top with Platinum Edge

(01506 top + 01467 base + 017097 power)

Available in five heights.

16" **29"** **36"** **40"** **42"**

Coffee Sitting K-8 Stand Working Standing



36" Square Café Table

Shown with 42" h, 30" Circular Base

Grey Nebula Top with Persian Blue Edge

(01503 top + 01457 base + 017097 power)

Café Tables Meeting

30" Square Café Table



Shown with 36"h, 24" crisscross base. Wild Cherry top with Black edge. (01501 top + 01460 base + 017097 power)

36" Round Café Table



Shown with 36"h, 24" circular base. Pewter Mesh top with Clementine edge. (01504 top + 01452 base + 017097 power)

36" Square Café Table



Shown with Grey Nebula top with Persian Blue edge. 42"h, 30" circular base. (01503 top + 01457 base + 017097 power)

30" Round Café Table



Shown with 42"h, 24" crisscross base. Asian Night top with Apple edge. (01502 top + 01461 base + 017097 power)

48" Round Café Table

Shown with 29"h, 30" circular base, New Age Oak top with Navy Edge. (01507 top + 01455 base + 017097 power)



42" Round Café Table

Shown with 29"h, 30" crisscross base, Flax Linen top with Platinum Edge. (01506 top + 01463 base + 017097 power)



Café Tables Meeting



30" Round Top with 40" Circular Base
 (Top 01502 + Base 01466 + 017098 Flat Power)

30" Round Top with 42" Circular Base
 (Top 01502 + Base 01453 + 017098 Flat Power)

42" Round Top with 29" Circular Base
 (Top 01506 + Base 01455, No Power)

36" Round Top with 36" Circular Base
 (Top 01504 + Base 01452, No Power)

36" Round Top with 16" Circular Base
 (Top 01504 + Base 01450, No Power)



Circular Base



Crisscross Base

Base Color Options

Crisscross and Circular bases are available in Platinum and Black. Both base options come with an extra durable coating that protects the integrity of the powdercoat finish over time.

● Platinum ● Black



CAFE BASE COMPATIBILITY CHART/RECOMMENDED PAIRING

	24" Circular	30" Circular	24" Crisscross	30" Crisscross
Round 30" dia.	X		X	
Round 36" dia.	X			X
Round 42" dia.		X		X
Round 48" dia.		X		
Square 30x30	X			X
Square 36x36		X		

Café Tables are a popular choice for creating casual meeting areas in commons, libraries and classrooms. Start by choosing (1) a top, (2) then choose from five heights: 42" Standing Height, 40" Working Height, 36" K-8 Standing Height, 29" Sitting Height or 16" Coffee Height. Next, choose from Circular or Crisscross styles. 42", 40" and 36" Standing Height models offer Backpack hooks, standard. (3) Choose optional power for the top, power cord runs out bottom of base. 1 1/4" thick top available in all standard finishes. Bases available in Platinum or Black.

1) Café Top — Choose Table Top

Model	Description	D"	W"	H"	F.C.	Cube	WT.	UPS	List Price
Square Café Table Tops									
01501	Square top only	30	30		70	1.5	29	*	\$ 161.00
01503	Square top only	36	36		70	2.25	42	*	\$ 190.00
Round Café Table Tops									
01502	Round top only	30"dia.			70	1.5	25	*	\$ 155.00
01504	Round top only	36"dia.			70	2.25	33	*	\$ 184.00
01506	Round top only	42"dia.			70	3.0	45	*	\$ 235.00
01507	Round top only	48"dia.			70	4.0	58		\$ 273.00

[View Chart on Page 212](#)

2) Café Base — Choose Base

Model	Description	D"	W"	H"	F.C.	Cube	WT.	UPS	List Price
Circular Bases									
01450	24" Circular Base Coffee Table Height	24"dia.		16	70	5.5	38	*	\$ 280.00
01451	24" Circular Base Sitting Height	24"dia.		29	70	6.75	39	*	\$ 290.00
01452	24" Circular Base K-8 Standing Height	24"dia.		36	70	8.5	42	*	\$ 300.00
01466	24" Circular Base Working Height	24"dia.		40	70	9.5	43	*	\$ 305.00
01453	24" Circular Base Standing Height	24"dia.		42	70	10.0	45	*	\$ 310.00
01454	30" Circular Base Coffee Table Height	30"dia.		16	70	8.5	55	*	\$ 345.00
01455	30" Circular Base Sitting Height	30"dia.		29	70	8.5	56	*	\$ 355.00
01456	30" Circular Base K-8 Standing Height	30"dia.		36	70	10.75	59	*	\$ 365.00
01467	30" Circular Base Working Height	30"dia.		40	70	12	60	*	\$ 370.00
01457	30" Circular Base Standing Height	30"dia.		42	70	12.25	62	*	\$ 375.00
Crisscross Bases									
01458	24" Crisscross Base Coffee Table Height	24"dia.		16	70	5.5	16	*	\$ 240.00
01459	24" Crisscross Base Sitting Height	24"dia.		29	70	6.75	17	*	\$ 250.00
01460	24" Crisscross Base K-8 Standing Height	24"dia.		36	70	8.5	20	*	\$ 260.00
01468	24" Crisscross Base Working Height	24"dia.		40	70	9.5	22	*	\$ 265.00
01461	24" Crisscross Base Standing Height	24"dia.		42	70	10.0	23	*	\$ 270.00
01462	30" Crisscross Base Coffee Table Height	30"dia.		16	70	8.5	20	*	\$ 260.00
01463	30" Crisscross Base Sitting Height	30"dia.		29	70	8.5	21	*	\$ 270.00
01464	30" Crisscross Base K-8 Standing Height	30"dia.		36	70	10.75	24	*	\$ 280.00
01469	30" Crisscross Base Working Height	30"dia.		40	70	12	26	*	\$ 285.00
01465	30" Crisscross Base Standing Height	30"dia.		42	70	12.25	27	*	\$ 290.00

3) Café Power — Choose Surface Power



Model	Description	F.C.	Cube	WT.	UPS	List Price
017097	Flat Surface Power Module 2 Power	70	.25	.5	*	\$ 175.00
017098	Flat Surface Power Module 1 Power/1 Twin USB	70	.25	.5	*	\$ 260.00
017079	Soft Touch Dome 2 Power/1 Twin USB	70	.25	.5	*	\$ 245.00
017078	Soft Touch Dome 3 Power	70	.25	.5	*	\$ 160.00

Before Nov

- New Pip / Mask
- Fake camera
- Calc. on 2nd strap
- H₂ O₂ Bandpass
- 2 swivel wheels (Dman)
- Fowler Sampling
- Sub-frame reverts
- Use 4m
- Efficiency / Downtime reduction
- pipelining
- wheels for cart
- Eled. Rack remount/cart

□ He compressor ^{MB} Shed

- MB □ Eled. rack remount
- MB □ Lead elec mount
- MB □ Hand He line plan
- He compressor leak IC → Rep

□ Study prechill vacuum ^{seal}

- Fibers to cleanroom

- TD □ Detectoe Cable Issues
 - bandwidth
 - length
- TD □ Connectors
 - Cable
 - Activity





Tables Meeting

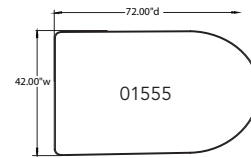
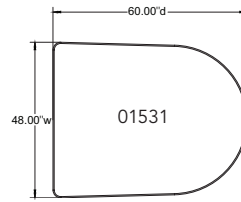

Multimedia Meeting Tables

Designed to accommodate four to five students in a compact area, these multimedia tables can be used for small group work or distance learning. They also offer the option of integrated power and USB connectivity, conveniently located on the work surface. Order it in any of 14 standard laminate colors, 20 edge colors, and Black or Platinum bases. 29", 36", 40" and 42" heights available.

Model 01555 top shown in Classic Linen with Black edge, with (2) 36" h Round Bases in Platinum, with optional 017097 Flat Surface Power Modules.



Crisscross Bases also available.

Model	Description	D"	W"	H"	F.C.	Cube	Wt.	UPS	List Price
Medium Multimedia Table									
01531	48"dx60" w Multimedia, top only requires two bases**	48	60	Close Base	70	4.0	85		\$ 299.00
01555	42"dx72" w Multimedia, top only requires two bases**	42	72		70	6.1	92		\$ 299.00
Optional Accessory									
17354*	TV Mount 32-50" Monitors/TVs	22	14	10	70		26		\$ 495.00

*Add "M" to table model number when ordering mount 17354. Mount will be centered. **See page 219 for base options.

Large Monitor Mount

The large monitor table mount allows 32–50" monitors or TVs to be easily mounted to a table for use in conferences, displays or presentations. Great for a multimedia table such as our Round End Group Table, 04137, 04138, 04139, 04140. This mount bolts to the table top for a sturdy long lasting presentation aide. Mount is adjustable in height to allow a variety of monitor sizes. **Accommodates VESA mounting, 100mm x 100mm to 400mm x 200mm**, and 100 lb. max weight. Also comes with a keyed lock for security. Available in Platinum only.



Cafe Meeting Tables Have Top and Edge Choices

1 1/4" TOP



Model	Description	D"	W"	H"	F.C.	Cube	Wt.	UPS	List Price
17354	TV Mount 32-50" Monitors/TVs	22	14	10	70		26		\$ 495.00

*Add "M" to table model number when ordering mount 17354. Mount will be centered.

Double Cafe Laminate Color Choice

- Asian Night **ANG**
- Classic Linen **CLN**
- Palisades Oak **PSO**
- New Age Oak **NEW**
- Grey Nebula **GNB**
- Boardwalk Oak **BWK**
- High Rise **HRE**
- Flax Linen **FLL**
- Wild Cherry **CHE**
- French Pear **FRP**
- Pewter Mesh **PEW**
- Buka Bark **BBK**
- Mission Maple **MIM**
- Fusion Maple **MAP**

Double Cafe Base (Column)

- Platinum **PLT**
- Black **BLA**

Double Cafe Edge Color Choice

- Apple **A**
- Burgundy **D**
- Charcoal **R**
- Forest Green **F**
- Mocha **T**
- Persian Blue **J**
- Red **L**
- Black **B**
- Cerulean **S**
- Chocolate **Q**
- Fuchsia **G**
- Navy **I**
- Platinum **P**
- Yellow **N**
- Blueberry **C**
- Champagne **O**
- Clementine **E**
- Mint **H**
- Orange **U**
- Purple **K**

View all finish options on page 271.

Note: The tables on these pages are oversized and leave factory with extra packaging.



Provide unique spaces with furniture that allows students to share their ideas.



48x60 Multimedia Meeting Table, Model 01531
Top shown in Pewter Mesh with Apple edge, with (2) 29" h Circular (01451) Bases in Platinum, with optional 017097 Flat Surface Power Modules and optional 17354 Monitor Mount.

Tables Meeting

Double Base Meeting Tables

Designed to accommodate four to six people, these tables with sleek contemporary looks can be used for small group work, distance learning or admin areas. They also offer the option of integrated power and USB connectivity, conveniently located on the work surfaces. Order them in 14 standard laminate colors, 20 edge colors, and Black or Platinum bases.

Classroom
Commons
Teacher Lounge



Oval Meeting Table

Top model 01527 shown with 42" h
Circular Bases in Black and with optional
017097 Flat Surface Power Modules.



Racetrack Meeting Table

Top model 01522 shown with 36" h
Circular Bases in Black.



Peanut Meeting Table

Top model 01520 shown with 36" h
Circular Bases in Platinum.



Rectangle Meeting Table

Top model 01524 shown with 29" h
Circular Bases in Platinum.

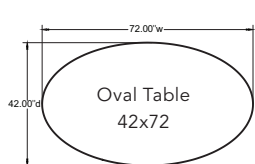

Model #01527

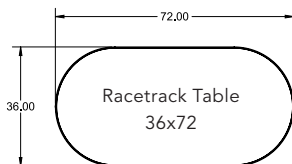

Model #01522

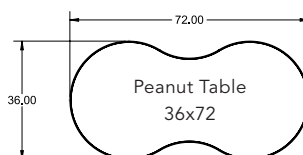

Model #01520

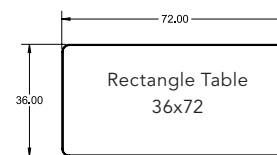

Model #01524

Choose (1) a top, (2) then choose from five heights: 42" Standing Height, 40" Working Height, 36" K-8 Standing Height, 29" Sitting Height or 16" Coffee Height. Next, choose from Circular or Crisscross styles. 42", 40" and 36" Standing Height models offer Backpack hooks, standard. (3) Choose optional power for the top, power cord runs out bottom of base. 1 1/4" thick top available in all standard finishes. Bases available in Platinum or Black. Double Cafe tables use two bases.

1) Double Café Top — Choose Table Top

Model	Description		D"	W"	H"	F.C.	Cube	WT.	UPS	List Price
Double Column Café Table Tops										
01520	Peanut top only	requires two bases	36	72	Choose base	70	5.3	70		\$ 249.00
01524	Rectangle top only	requires two bases	36	72		70	5.3	84		\$ 249.00
01527	Oval top only	requires two bases	42	72		70	4.0	77		\$ 299.00
01522	Racetrack top only	requires two bases	36	72		70	5.3	75		\$ 249.00
01531	48"dx60"w Multimedia top only	requires two bases	48	60		70	4.0	85		\$ 299.00
01555	42"dx72"w Multimedia top only	requires two bases	42	72		70	6.1	92		\$ 299.00
<i>Specify two bases per top, prices are for one base.</i>										

2) Café Base — Order Two Bases

Model	Description		D"	W"	H"	F.C.	Cube	WT.	UPS	List Price
Circular Bases										
01450	24"dia. Circular Base	Coffee Table Height	24"dia.		16	70	5.5	38	*	\$ 280.00
01451	24"dia. Circular Base	Sitting Height	24"dia.		29	70	6.75	39	*	\$ 290.00
01452	24"dia. Circular Base	K-8 Standing Height	24"dia.		36	70	8.5	42	*	\$ 300.00
01466	24"dia. Circular Base	Working Height	24"dia.		40	70	9.5	21.5	*	\$ 305.00
01453	24"dia. Circular Base	Standing Height	24"dia.		42	70	10.0	45	*	\$ 310.00
Crisscross Bases										
01458	24"dia. Crisscross Base	Coffee Table Height	24"dia.		16	70	5.5	16	*	\$ 240.00
01459	24"dia. Crisscross Base	Sitting Height	24"dia.		29	70	6.75	17	*	\$ 250.00
01460	24"dia. Crisscross Base	K-8 Standing Height	24"dia.		36	70	8.5	20	*	\$ 260.00
01468	24"dia. Crisscross Base	Working Height	24"dia.		40	70	9.5	22	*	\$ 265.00
01461	24"dia. Crisscross Base	Standing Height	24"dia.		42	70	10.0	23	*	\$ 270.00

3) Café Power — Choose Surface Power



Model	Description		F.C.	Cube	WT.	UPS	List Price
017097	Flat Surface Power Module	2 Power	70	.25	.5	*	\$ 175.00
017098	Flat Surface Power Module	1 Power/1 Twin USB	70	.25	.5	*	\$ 260.00
017079	Soft Touch Dome	2 Power/1 Twin USB	70	.25	.5	*	\$ 245.00
017078	Soft Touch Dome	3 Power	70	.25	.5	*	\$ 160.00



24" Circular Base



24" Crisscross Base

Base Color Options

Crisscross and Circular bases are available in Platinum and Black. Both base options come with an extra durable coating that protects the integrity of the powdercoat finish over time.

- Platinum
- Black



Plan (Assignment 1)

Reference types

- comparison operator ==
- method calls

Object oriented programming



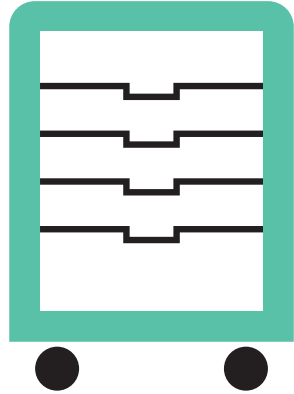

Storage

Imagine a classroom where four or five groups of six students are working on projects. The teacher circulates about, providing information, direction and encouragement. To allow for all this activity, materials and resources must be organized and readily available to students. Independent access to resources for students frees the teacher to direct and instruct as needed. That's the idea behind Cascade.

Built for Learning.





Cascade

Make room

9 Sizes. Totes or shelves.



Cases

See page 230



Cabinets

See page 234



Towers

See page 238



Maker Table

See page 242



Whiteboard

See page 244



Noteboard

See page 245



Peg Board

See page 247



Cubbies

See page 248



Presentation

See page 250



Teacher Desks

See page 254

Teacher tote storage and transfer.

Cascade® totes can transfer between Teacher Storage and Desk.



Student tote storage and transfer.

Cascade totes containing student work can transfer directly from the storage unit to under-desk-top and back.



Cascade® Storage System

Tailored to every school room and curriculum.

- Nine sizes
- Casters or glides
- Totes, shelves or cubbies
- 19 powder coat colors
- White board back on Mega-Tower size

Cascade Cases

See page 230

Equip your Cascade Case with tote trays to hold a wide variety of learning materials. Add utility with an optional riser shelf and lectern.



Mini-Case



Mid-Case



Mega-Case



Cascade Cabinets

See page 234

Available with tote trays, it holds a wide variety of learning materials. Optional riser shelf and lectern make this perfect for presentations.



Mini-Cabinet



Mid-Cabinet



Mega-Cabinet



Cascade Towers

See page 238

Available with tote trays, it holds a wide variety of learning materials. Provides maximum capacity and can be configured many ways.



Mini-Tower



Mid-Tower



Mega-Tower



Cascade Cases

See page 230

Equip your Cascade Case with shelves to hold a wide variety of learning materials. Add utility with an optional riser shelf and lectern.



Mini-Case

Mid-Case

Mega-Case

Cascade Cabinets

See page 234

Available with shelves, it holds a wide variety of learning materials. Optional riser shelf and lectern make this perfect for presentations.



Mini-Cabinet

Mid-Cabinet

Mega-Cabinet

Cascade Towers

See page 238

Available with shelves, it holds a wide variety of learning materials. Provides maximum capacity and can be configured many ways.



Mini-Tower

Mid-Tower

Mega-Tower

Cascade® Storage System

A customizable system for organizing, storing, distributing and presenting materials.

Arc, Huddle®, Silhouette®, Planner® and Interchange® Desks



**Interchange Wing Desk,
Model 03095**

Shown with a SW Tote Tray, Model 66013.
See page 92



**Interchange 20x27,
Model 04080**

Shown with a SW Tote Tray, Model 66013.
See page 102



**Interchange Diamond Desk,
Model 03082**

Shown with a SW Tote Tray, Model 66013.
See page 87



**Silhouette Arc Desk,
Model 01620**

Shown with SW tote 30925.
See page 160



**Huddle-8 LS Student Desk,
Model 01267**

Shown with a SW tote 30925.
See page 184



**Silhouette Student Desk,
Model 01600**

Shown with an EW Tote Tray, Model 30926.
See page 158



**Planner Student Desk,
Model 01272**

Shown with an EW Tote Tray, Model 30926.
See page 186



To learn more, watch the Cascade Storage Video:
smithsystem.com/cascade-storage

Organizing project learning.

The teacher organizes project materials in a tote tray to be assigned to a group. This makes it easy for the group to share the materials without separating (and possibly losing) any.



Cascade Tote Compatibility

Desks	SW* 30925	EW* 30926
Silhouette	✓	✓
Planner Student	✓	✓
Planner Two-Student	✓	✓
Planner Three-Student	✓	✓
Silhouette Arc	✓	✓
Huddle - 8 LS	✓	✗
Sequence	✓	✗
Huddle - 6	✗	✗
Huddle - 8	✗	✗
Interchange Desks	66013	
Diamond	✓	✗
Diamond Two-Student	✓	✗
Mini Diamond	✓	✗
Wing	✓	✗
20x27	✓	✗
Curve	✓	✗
3-2-1 LS	✓	✗

*SW = Standard Width EW = Extra Wide Width



Riser Shelf



Lectern
Case only.



Two-Sided Whiteboard Unit



Laptop Shelf
Optional Laptop Shelf
Model 17670 PLT

Cascade® Cases

Cascade Mini-Case

These compact, versatile, mobile storage units are available with either tote trays or shelves and can be fitted with numerous options including locking doors, and a riser shelf. Our Cascade Storage System allows educators to organize, store and distribute learning materials. These mobile storage units are highly customizable to hold items in a wide range of sizes and shapes — from sheets of paper to art supplies.



Cascade Mid-Case

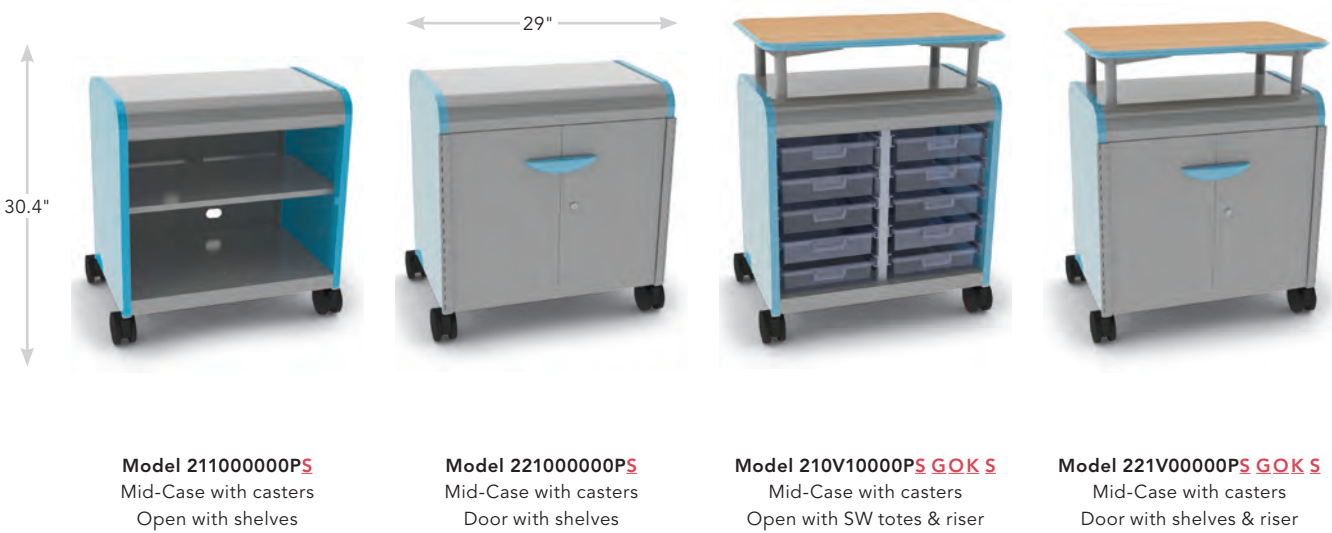

Cascade Mega-Case

43"



Model 310015000PE
Mega-Case with casters
Open with SW totes

30.4"



Model 321000000PE
Mega-Case with casters
Door with shelves



Model 311100000PE GOK F
Mega-Case with casters
Open with shelves and riser

37"



Model 321100000PE GOK F
Mega-Case with casters
Door with shelves and riser



Laptop Shelf

Optional Laptop Shelf **Model 17670 PLT**
\$ 130.00 (Available when ordering a riser shelf).

Cascade Mini-Case



Model	Description	D"	W"	H"	F.C.	WT.	List Price
Shelves							
111000000P_	Open w/shelves w/casters	19	21	30.4	100	49	\$ 504.00
121000000P_	Door w/shelves w/casters	19	21	30.4	100	56	\$ 576.00
111V00000P_	Open w/shelves w/casters & riser	19	21	37	100	65	\$ 737.00
121V00000P_	Door w/shelves w/casters & riser	19	21	37	100	72	\$ 811.00
111L00000P_	Open w/shelves w/casters & lectern	19	21	41.5	100	67	\$ 746.00
121L00000P_	Door w/shelves w/casters & lectern	19	21	41.5	100	74	\$ 818.00
Extra Wide (EW) Totes							
110005000P_	Open w/five 3" EW totes w/casters	19	21	30.4	100	52	\$ 745.00
120005000P_	Door w/five 3" EW totes w/casters	19	21	30.4	100	59	\$ 825.00
110V05000P_	Open w/five 3" EW totes w/casters & riser	19	21	37	100	69	\$ 1,001.00
120V05000P_	Door w/five 3" EW totes w/casters & riser	19	21	37	100	76	\$ 1,084.00
110L05000P_	Open w/five 3" EW totes w/casters & lectern	19	21	41.5	100	71	\$ 1,012.00
120L05000P_	Door w/five 3" EW totes w/casters & lectern	19	21	41.5	100	78	\$ 1,092.00
110003010P_	Open w/three 3" & one 6" EW tote w/casters	19	21	30.4	100	53	\$ 717.00
120003010P_	Door w/three 3" & one 6" EW tote w/casters	19	21	30.4	100	60	\$ 798.00
110V03010P_	Open w/three 3" & one 6" EW tote w/casters & riser	19	21	37	100	69	\$ 975.00
120V03010P_	Door w/three 3" & one 6" EW tote w/casters & riser	19	21	37	100	76	\$ 1,056.00
110L03010P_	Open w/three 3" & one 6" EW tote w/casters & lectern	19	21	41.5	100	73	\$ 986.00
120L03010P_	Door w/three 3" & one 6" EW tote w/casters & lectern	19	21	41.5	100	80	\$ 1,065.00

Cascade Mid-Case



Model	Description	D"	W"	H"	F.C.	WT.	List Price
Shelves							
211000000P_	Open w/shelves w/casters	19	29	30.4	100	63	\$ 628.00
221000000P_	Doors w/shelves w/casters	19	29	30.4	100	74	\$ 757.00
211V00000P_	Open w/shelves w/casters & riser	19	29	37	100	87	\$ 884.00
221V00000P_	Doors w/shelves w/casters & riser	19	29	37	100	98	\$ 1,013.00
211L00000P_	Open w/shelves w/casters & lectern	19	29	41.5	100	89	\$ 894.00
221L00000P_	Doors w/shelves w/casters & lectern	19	29	41.5	100	100	\$ 1,022.00
Standard Width (SW) Totes							
210010000P_	Open w/ten 3" SW totes w/casters	19	29	30.4	100	69	\$ 905.00
220010000P_	Doors w/ten 3" SW totes w/casters	19	29	30.4	100	80	\$ 1,046.00
210V10000P_	Open w/ten 3" SW totes w/casters & riser	19	29	37	100	93	\$ 1,188.00
220V10000P_	Doors w/ten 3" SW totes w/casters & riser	19	29	37	100	104	\$ 1,328.00
210L10000P_	Open w/ten 3" SW totes w/casters & lectern	19	29	41.5	100	95	\$ 1,197.00
220L10000P_	Doors w/ten 3" SW totes w/casters & lectern	19	29	41.5	100	106	\$ 1,339.00
210006020P_	Open w/six 3" & two 6" SW totes w/casters	19	29	30.4	100	70	\$ 883.00
220006020P_	Doors w/six 3" & two 6" SW totes w/casters	19	29	30.4	100	81	\$ 1,024.00
210V06020P_	Open w/six 3" & two 6" SW totes w/casters & riser	19	29	37	100	95	\$ 1,166.00
220V06020P_	Doors w/six 3" & two 6" SW totes w/casters & riser	19	29	37	100	106	\$ 1,306.00
210L06020P_	Open w/six 3" & two 6" SW totes w/casters & lectern	19	29	41.5	100	97	\$ 1,176.00
220L06020P_	Doors w/six 3" & two 6" SW totes w/casters & lectern	19	29	41.5	100	108	\$ 1,317.00

Cascade Mega-Case



Model	Description	D"	W"	H"	F.C.	WT.	List Price
Shelves							
31100000P_	Open w/shelves w/casters	19	43	30.4	100	82	\$ 803.00
32100000P_	Doors w/shelves w/casters	19	43	30.4	100	96	\$ 965.00
31110000P_	Open w/shelves w/casters & riser	19	43	37	100	117	\$ 1,077.00
32110000P_	Doors w/shelves w/casters & riser	19	43	37	100	131	\$ 1,231.00
311J0000P_	Open w/shelves w/casters & lectern	19	43	41.5	100	119	\$ 1,086.00
321J0000P_	Doors w/shelves w/casters& lectern	19	43	41.5	100	133	\$ 1,240.00
Standard Width (SW) Totes							
310015000P_	Open w/fifteen 3" SW totes w/casters	19	43	30.4	100	90	\$ 1,203.00
320015000P_	Doors w/fifteen 3" SW totes w/casters	19	43	30.4	100	104	\$ 1,373.00
310115000P_	Open w/fifteen 3" SW totes w/casters & riser	19	43	37	100	115	\$ 1,505.00
320115000P_	Doors w/fifteen 3" SW totes w/casters & riser	19	43	37	100	129	\$ 1,675.00
310J15000P_	Open w/fifteen 3" SW totes w/casters & lectern	19	43	41.5	100	117	\$ 1,516.00
320J15000P_	Doors w/fifteen 3" SW totes w/casters & lectern	19	43	41.5	100	131	\$ 1,684.00
310009030P_	Open w/nine 3" & three 6" SW totes w/casters	19	43	30.4	100	92	\$ 1,172.00
320009030P_	Doors w/nine 3" & three 6" SW totes w/casters	19	43	30.4	100	106	\$ 1,341.00
310109030P_	Open w/nine 3" & three 6" SW totes w/casters & riser	19	43	37	100	117	\$ 1,473.00
320109030P_	Doors w/nine 3" & three 6" SW totes w/casters & riser	19	43	37	100	131	\$ 1,642.00
310J09030P_	Open w/nine 3" & three 6" SW totes w/casters & lectern	19	43	41.5	100	119	\$ 1,483.00
320J09030P_	Doors w/nine 3" & three 6" SW totes w/casters & lectern	19	43	41.5	100	133	\$ 1,652.00
Extra Wide (EW) Totes							
A10010000P_	Open w/ten 3" EW totes w/casters	19	43	30.4	100	92	\$ 1,265.00
A20010000P_	Doors w/ten 3" EW totes w/casters	19	43	30.4	100	106	\$ 1,433.00
A10110000P_	Open w/ten 3" EW totes w/casters & riser	19	43	37	100	117	\$ 1,566.00
A20110000P_	Doors w/ten 3" EW totes w/casters & riser	19	43	37	100	131	\$ 1,736.00
A10J10000P_	Open w/ten 3" EW totes w/casters & lectern	19	43	41.5	100	119	\$ 1,576.00
A20J10000P_	Doors w/ten 3" EW totes w/casters & lectern	19	43	41.5	100	133	\$ 1,746.00
A10006020P_	Open w/six 3" & two 6" EW totes w/casters	19	43	30.4	100	92	\$ 1,210.00
A20006020P_	Doors w/six 3" & two 6" EW totes w/casters	19	43	30.4	100	106	\$ 1,378.00
A10106020P_	Open w/six 3" & two 6" EW totes w/casters & riser	19	43	37	100	117	\$ 1,510.00
A20106020P_	Doors w/six 3" & two 6" EW totes w/casters & riser	19	43	37	100	131	\$ 1,680.00
A10J06020P_	Open w/six 3" & two 6" EW totes w/casters & lectern	19	43	41.5	100	119	\$ 1,521.00
A20J06020P_	Doors w/six 3" & two 6" EW totes w/casters & lectern	19	43	41.5	100	133	\$ 1,691.00

Cascade Laminate Color Choice

● Asian Night ANG	● Pewter Mesh PEW	● High Rise HRE	● Palisades Oak PSO	● Mission Maple MIM	● Wild Cherry CHE	● Grey Nebula GNB
● Boardwalk Oak BWK	● Classic Linen CLN	● Buka Bark BBK	● Flax Linen FLL	● New Age Oak NEW	● Fusion Maple MAP	● French Pear FRP

Cascade End Panel and Edge Color Choice

● Apple A	● Burgundy D	● Charcoal R	● Forest Green F	● Mocha T	● Persian Blue J	● Red L
● Black B	● Cerulean S	● Chocolate Q	● Fuchsia G	● Navy I	● Platinum P	● Yellow N
● Blueberry C	● Champagne O*	● Clementine E	● Mint H	● Orange U	● Purple K	

View all finish options on page 271. *Champagne edge color only.

10 day lead time for orders of 20 or less. 21 or more subject to 8 week lead time. Extended lead times may apply to Chocolate, Fuchsia, Mint, Mocha and Yellow.

Cascade® Cabinets

Cascade Mini-Cabinet

These versatile, mobile storage units with a large capacity and a small footprint are available with either tote trays or shelves and can be fitted with numerous options including locking doors, and a riser shelf. Our Cascade Storage System allows educators to organize, store and distribute learning materials. These mobile storage units are highly customizable to hold items in a wide range of sizes and shapes — from sheets of paper to art supplies.



Model 411000000PC
Mini-Cabinet with casters
Open with shelves

Model 421000000PC
Mini-Cabinet with casters
Door with shelves

Model 410V08000PC GOK C
Mini-Cabinet with casters
Open with EW totes & riser

Model 421V00000PC GOK C
Mini-Cabinet with casters
Door with shelves & riser

Cascade Mid-Cabinet



Model 511000000PQ
Mid-Cabinet with casters
Open with shelves

Model 521000000PQ
Mid-Cabinet with casters
Door with shelves

Model 510V16000PQ GOK Q
Mid-Cabinet with casters
Open with SW totes & riser

Model 521V00000PQ GOK Q
Mid-Cabinet with casters
Door with shelves & riser

Cascade Mega-Cabinet



Model B11000000PH
Mega-Cabinet with casters
Open with shelves



Model B21000000PH
Mega-Cabinet with casters
Door with shelves

43"



Model B10116000PH GOK H
Mega-Cabinet with casters
Open with EW totes & riser



Model B21100000PH GOK H
Mega-Cabinet with casters
Door with shelves & riser



**Optional Laptop Shelf
Model 17670 PLT**
\$ 130.00 (Available when ordering a riser shelf).



**Whiteboard Back Available
Mega-Cabinets.**
Add W__ to 4th character to order. Example on page 244.

Cascade Laminate Color Choice

- Asian Night **ANG**
- Pewter Mesh **PEW**
- High Rise **HRE**
- Palisades Oak **PSO**
- Mission Maple **MIM**
- Wild Cherry **CHE**
- Grey Nebula **GNB**
- Boardwalk Oak **BWK**
- Classic Linen **CLN**
- Buka Bark **BBK**
- Flax Linen **FLL**
- New Age Oak **NEW**
- Fusion Maple **MAP**
- French Pear **FRP**

Cascade End Panel and Edge Color Choice

- Apple **A**
- Burgundy **D**
- Charcoal **R**
- Forest Green **F**
- Mocha **T**
- Persian Blue **J**
- Red **L**
- Black **B**
- Cerulean **S**
- Chocolate **Q**
- Fuchsia **G**
- Navy **I**
- Platinum **P**
- Yellow **N**
- Blueberry **C**
- Champagne **O***
- Clementine **E**
- Mint **H**
- Orange **U**
- Purple **K**

View all finish options on page 271. *Champagne edge color only.

10 day lead time for orders of 20 or less. 21 or more subject to 8 week lead time. Extended lead times may apply to Chocolate, Fuchsia, Mint, Mocha and Yellow.

Cascade® Cabinets

Cascade Mini-Cabinet



Model	Description	D"	W"	H"	F.C.	WT.	List Price
Shelves							
41100000P_	Open w/shelves w/casters	19	21	43.3	100	63	\$ 640.00
42100000P_	Door w/shelves w/casters	19	21	43.3	100	73	\$ 741.00
411V00000P_	Open w/shelves w/casters & riser	19	21	50	100	78	\$ 875.00
421V00000P_	Door w/shelves w/casters & riser	19	21	50	100	88	\$ 976.00
Extra Wide (EW) Totes							
410008000P_	Open w/eight 3" EW totes w/casters	19	21	43.3	100	74	\$ 1,010.00
420008000P_	Door w/eight 3" EW totes w/casters	19	21	43.3	100	84	\$ 1,121.00
410V08000P_	Open w/eight 3" EW totes w/casters & riser	19	21	50	100	89	\$ 1,267.00
420V08000P_	Door w/eight 3" EW totes w/casters & riser	19	21	50	100	99	\$ 1,378.00
410004020P_	Open w/four 3" and two 6" EW totes w/casters	19	21	43.3	100	72	\$ 955.00
420004020P_	Door w/four 3" and two 6" EW totes w/casters	19	21	43.3	100	82	\$ 1,067.00
410V04020P_	Open w/four 3" and two 6" EW totes w/casters & riser	19	21	50	100	87	\$ 1,213.00
420V04020P_	Door w/four 3" and two 6" EW totes w/casters & riser	19	21	50	100	97	\$ 1,324.00
410000040P_	Open w/four 6" EW totes w/casters	19	21	43.3	100	72	\$ 900.00
420000040P_	Door w/four 6" EW totes w/casters	19	21	43.3	100	82	\$ 1,012.00
410V00040P_	Open w/four 6" EW totes w/casters & riser	19	21	50	100	87	\$ 1,158.00
420V00040P_	Door w/four 6" EW totes w/casters & riser	19	21	50	100	97	\$ 1,268.00

Cascade Mid-Cabinet



Model	Description	D"	W"	H"	F.C.	WT.	List Price
Shelves							
511000000P_	Open w/shelves w/casters	19	29	43.3	100	81	\$ 789.00
521000000P_	Doors w/shelves w/casters	19	29	43.3	100	97	\$ 965.00
511V00000P_	Open w/shelves w/casters & riser	19	29	50	100	101	\$ 1,045.00
521V00000P_	Doors w/shelves w/casters & riser	19	29	50	100	117	\$ 1,221.00
Standard Width (SW) Totes							
510016000P_	Open w/sixteen 3" SW totes w/casters	19	29	43.3	100	97	\$ 1,210.00
520016000P_	Doors w/sixteen 3" SW totes w/casters	19	29	43.3	100	113	\$ 1,403.00
510V16000P_	Open w/sixteen 3" SW totes w/casters & riser	19	29	50	100	117	\$ 1,493.00
520V16000P_	Doors w/sixteen 3" SW totes w/casters & riser	19	29	50	100	123	\$ 1,685.00
510008040P_	Open w/eight 3" and four 6" SW totes w/casters	19	29	43.3	100	95	\$ 1,167.00
520008040P_	Doors w/eight 3" and four 6" SW totes w/casters	19	29	43.3	100	111	\$ 1,361.00
510V08040P_	Open w/eight 3" and four 6" SW totes w/casters & riser	19	29	50	100	115	\$ 1,449.00
520V08040P_	Doors w/eight 3" and four 6" SW totes w/casters & riser	19	29	50	100	121	\$ 1,642.00
510000080P_	Open w/eight 6" SW totes w/casters	19	29	43.3	100	95	\$ 1,123.00
520000080P_	Doors w/eight 6" SW totes w/casters	19	29	43.3	100	111	\$ 1,318.00
510V00080P_	Open w/eight 6" SW totes w/casters & riser	19	29	50	100	115	\$ 1,406.00
520V00080P_	Doors w/eight 6" SW totes w/casters & riser	19	29	50	100	121	\$ 1,601.00

Cascade Laminate Color Choice

- Asian Night **ANG**
- Pewter Mesh **PEW**
- High Rise **HRE**
- Palisades Oak **PSO**
- Mission Maple **MIM**
- Wild Cherry **CHE**
- Grey Nebula **GNB**
- Boardwalk Oak **BWK**
- Classic Linen **CLN**
- Buka Bark **BBK**
- Flax Linen **FLL**
- New Age Oak **NEW**
- Fusion Maple **MAP**
- French Pear **FRP**

Cascade End Panel and Edge Color Choice

- Apple **A**
- Burgundy **D**
- Charcoal **R**
- Forest Green **F**
- Mocha **T**
- Persian Blue **J**
- Red **L**
- Black **B**
- Cerulean **S**
- Chocolate **Q**
- Fuchsia **G**
- Navy **I**
- Platinum **P**
- Yellow **N**
- Blueberry **C**
- Champagne **O***
- Clementine **E**
- Mint **H**
- Orange **U**
- Purple **K**

View all finish options on page 271. *Champagne edge color only.

10 day lead time for orders of 20 or less. 21 or more subject to 8 week lead time. Extended lead times may apply to Chocolate, Fuchsia, Mint, Mocha and Yellow.

Cascade Mega-Cabinet



Model	Description	D"	W"	H"	F.C.	WT.	List Price
Shelves with glides							
B31000000P_	Open w/shelves w/glides	19	43	38.4	100	100	\$ 972.00
B41000000P_	Doors w/shelves w/glides	19	43	38.4	100	119	\$ 1,185.00
B31100000P_----	Open w/shelves w/glides & riser	19	43	45	100	126	\$ 1,247.00
B41100000P_----	Doors w/shelves w/glides & riser	19	43	45	100	144	\$ 1,460.00
Shelves with casters							
B11000000P_	Open w/shelves w/casters	19	43	43.3	100	105	\$ 1,000.00
B21000000P_	Doors w/shelves w/casters	19	43	43.3	100	124	\$ 1,213.00
B11100000P_----	Open w/shelves w/casters & riser	19	43	50	100	131	\$ 1,275.00
B21100000P_----	Doors w/shelves w/casters & riser	19	43	50	100	149	\$ 1,487.00
Standard Width (SW) Totes							
610024000P_	Open w/twenty-four 3" SW totes w/casters	19	43	43.3	100	132	\$ 1,615.00
620024000P_	Doors w/twenty-four 3" SW totes w/casters	19	43	43.3	100	150	\$ 1,847.00
610124000P_----	Open w/twenty-four 3" SW totes w/casters & riser	19	43	50	100	158	\$ 1,900.00
620124000P_----	Doors w/twenty-four 3" SW totes w/casters & riser	19	43	50	100	176	\$ 2,149.00
610012060P_	Open w/twelve 3" and six 6" SW totes w/casters	19	43	43.3	100	132	\$ 1,549.00
620012060P_	Doors w/twelve 3" and six 6" SW totes w/casters	19	43	43.3	100	150	\$ 1,783.00
610112060P_----	Open w/twelve 3" and six 6" SW totes w/casters & riser	19	43	50	100	158	\$ 1,851.00
620112060P_----	Doors w/twelve 3" and six 6" SW totes w/casters & riser	19	43	50	100	176	\$ 2,085.00
Extra Wide (EW) Totes							
B10016000P_	Open w/sixteen 3" EW totes w/casters	19	43	43.3	100	132	\$ 1,711.00
B20016000P_	Doors w/sixteen 3" EW totes w/casters	19	43	43.3	100	150	\$ 1,945.00
B10116000P_----	Open w/sixteen 3" EW totes w/casters & riser	19	43	50	100	158	\$ 2,013.00
B20116000P_----	Doors w/sixteen 3" EW totes w/casters & riser	19	43	50	100	176	\$ 2,232.00
B1000080P_	Open w/eight 6" EW totes w/casters	19	43	43.3	100	132	\$ 1,493.00
B2000080P_	Doors w/eight 6" EW totes w/casters	19	43	43.3	100	150	\$ 1,725.00
B1010080P_----	Open w/eight 6" EW totes w/casters & riser	19	43	50	100	158	\$ 1,794.00
B2010080P_----	Doors w/eight 6" EW totes w/casters & riser	19	43	50	100	176	\$ 2,027.00
B10008040P_	Open w/eight 3" and four 6" EW totes w/casters	19	43	43.3	100	132	\$ 1,605.00
B20008040P_	Doors w/eight 3" and four 6" EW totes w/casters	19	43	43.3	100	150	\$ 1,838.00
B10108040P_----	Open w/eight 3" and four 6" EW totes w/casters & riser	19	43	50	100	158	\$ 1,907.00
B20108040P_----	Doors w/eight 3" and four 6" EW totes w/casters & riser	19	43	50	100	176	\$ 2,140.00

Note: When ordering a Riser Shelf for a Mega-Cabinet, 1 1/4" thick top is only option available.



Whiteboard Back available on Mega-Cabinets.
Add W__ to 4th character to order. Example on page 244.

Cascade Cabinet Lectern



Model	Description	D"	W"	H"	F.C.	WT.	List Price
Cascade Mini-Cabinet*							
411L00000P_----	Open w/shelves w/casters & lectern	19	21	48	100	80	\$ 949.00
Cascade Mid-Cabinet*							
511L00000P_----	Open w/shelves w/casters & lectern	19	29	48	100	103	\$ 1,055.00
Cascade Mega-Cabinet*							
611J00000P_----	Open w/shelves w/casters & lectern	19	43	48	100	128	\$ 1,283.00

* with casters

Cascade® Towers

Cascade Mini-Tower

These versatile, mobile storage units with a large capacity and a small footprint are available with either tote trays or shelves and can be fitted with locking doors. Our Cascade Storage System allows educators to organize, store and distribute learning materials. These mobile storage units are highly customizable to hold items in a wide range of sizes and shapes — from sheets of paper to art supplies.



Model 711000000PG
Mini-Tower with casters
Open with shelves

Model 721000000PG
Mini-Tower with casters
Door with shelves

Model 710012000PG
Mini-Tower with casters
Open with EW totes

Model 720012000PG
Mini-Tower with casters
Door with EW totes

Cascade Mid-Tower



Model 811000000PE
Mid-Tower with casters
Open with shelves

Model 821000000PE
Mid-Tower with casters
Door with shelves

Model 810024000PE
Mid-Tower with casters
Open with SW totes

Model 820024000PE
Mid-Tower with casters
Door with SW totes

Cascade Mega-Tower



Model 911000000P!
Mega-Tower with casters
Open with shelves

43"



Model 921000000P!
Mega-Tower with casters
Door with shelves



61.4"

Model 910009093P!
Mega-Tower with casters
Open with SW totes



Model C10024000PA
Mega-Tower with casters
Open with EW totes

Cascade End Panel and Edge Color Choice

- | | | | | | | |
|---------------|----------------|----------------|------------------|------------|------------------|------------|
| ● Apple A | ● Burgundy D | ● Charcoal R | ● Forest Green F | ● Mocha T | ● Persian Blue J | ● Red L |
| ● Black B | ● Cerulean S | ● Chocolate Q | ● Fuchsia G | ● Navy I | ● Platinum P | ● Yellow N |
| ● Blueberry C | ● Champagne O* | ● Clementine E | ● Mint H | ● Orange U | ● Purple K | |

View all finish options on page 271. *Champagne edge color only.

10 day lead time for orders of 20 or less. 21 or more subject to 8 week lead time. Extended lead times may apply to Chocolate, Fuchsia, Mint, Mocha and Yellow.

Cascade® Towers



Cascade Mini-Tower

Model	Description	D"	W"	H"	F.C.	WT.	List Price
Shelves							
711000000P_	Open w/shelves w/casters	19	21	61.4	100	81	\$ 803.00
721000000P_	Door w/shelves w/casters	19	21	61.4	100	97	\$ 944.00
Extra Wide (EW) Totes							
710012000P_	Open w/twelve 3" EW totes w/casters	19	21	61.4	100	96	\$ 1,341.00
720012000P_	Door w/twelve 3" EW totes w/casters	19	21	61.4	100	112	\$ 1,496.00
710003050P_	Open w/three 3" and five 6" EW totes w/casters	19	21	61.4	100	94	\$ 1,242.00
720003050P_	Door w/three 3" and five 6" EW totes w/casters	19	21	61.4	100	110	\$ 1,397.00
710000060P_	Open w/six 6" EW totes w/casters	19	21	61.4	100	96	\$ 1,176.00
720000060P_	Door w/six 6" EW totes w/casters	19	21	61.4	100	112	\$ 1,331.00



Cascade Mid-Tower

Model	Description	D"	W"	H"	F.C.	WT.	List Price
Shelves							
811000000P_	Open w/shelves w/casters	19	29	61.4	100	102	\$ 987.00
821000000P_	Doors w/shelves w/casters	19	29	61.4	100	128	\$ 1,239.00
Standard Width (SW) Totes							
810024000P_	Open w/twenty-four 3" SW totes w/casters	19	29	61.4	100	125	\$ 1,599.00
820024000P_	Doors w/twenty-four 3" SW totes w/casters	19	29	61.4	100	151	\$ 1,874.00
810006062P_	Open w/six 3" and six 6" and two 12" SW totes w/casters	19	29	61.4	100	121	\$ 1,507.00
820006062P_	Doors w/six 3" and six 6" and two 12" SW totes w/casters	19	29	61.4	100	147	\$ 1,783.00
810000120P_	Open w/twelve 6" SW totes w/casters	19	29	61.4	100	125	\$ 1,471.00
820000120P_	Doors w/twelve 6" SW totes w/casters	19	29	61.4	100	151	\$ 1,747.00



Cascade Mega-Tower

Model	Description	D"	W"	H"	F.C.	WT.	List Price
Shelves							
911000000P_	Open w/shelves w/casters	19	43	61.4	100	134	\$ 1,241.00
921000000P_	Doors w/shelves w/casters	19	43	61.4	100	167	\$ 1,546.00
911W00000P_	Open w/shelves and whiteboard back w/casters	19	43	61.4	100	134	\$ 1,456.00
921W00000P_	Doors w/shelves and whiteboard back w/casters	19	43	61.4	100	167	\$ 1,761.00
Standard Width (SW) Totes							
910036000P_	Open w/thirty-six 3" SW totes w/casters	19	43	61.4	100	209	\$ 2,134.00
920036000P_	Doors w/thirty-six 3" SW totes w/casters	19	43	61.4	100	242	\$ 2,468.00
910009093P_	Open w/nine 3" and nine 6" and three 12" SW totes w/casters	19	43	61.4	100	209	\$ 1,997.00
920009093P_	Doors w/nine 3" and nine 6" and three 12" SW totes w/casters	19	43	61.4	100	242	\$ 2,332.00
910009150P_	Open w/nine 3" and fifteen 6" SW totes w/casters	19	43	61.4	100	209	\$ 2,037.00
920009150P_	Doors w/nine 3" and fifteen 6" SW totes w/casters	19	43	61.4	100	242	\$ 2,372.00
Extra Wide (EW) Totes							
C10024000P_	Open w/twenty-four 3" EW totes w/casters	19	43	61.4	100	209	\$ 2,280.00
C20024000P_	Doors w/twenty-four 3" EW totes w/casters	19	43	61.4	100	242	\$ 2,616.00
C10014060P_	Open w/fourteen 3" and six 6" EW totes w/casters	19	43	61.4	100	209	\$ 2,190.00
C20014060P_	Doors w/fourteen 3" and six 6" EW totes w/casters	19	43	61.4	100	242	\$ 2,526.00



Cascade Mega-Tower with thirty-six SW totes. Shown in Red.

Cascade® Mega-Tower Optional Configurations



Whiteboard Back
Details on page 244.



Combination Tote & Shelf
Details on page 246.



Pegboard Side Panels
Details on page 245.



Mega-Tower Cubby
Details on page 248.



Teacher Wardobe
Details on page 252.

Cascade End Panel and Edge Color Choice

● Apple A	● Burgundy D	● Charcoal R	● Forest Green F	● Mocha T	● Persian Blue J	● Red L
● Black B	● Cerulean S	● Chocolate Q	● Fuchsia G	● Navy I	● Platinum P	● Yellow N
● Blueberry C	● Champagne O*	● Clementine E	● Mint H	● Orange U	● Purple K	

View all finish options on page 271. *Champagne edge color only.

10 day lead time for orders of 20 or less. 21 or more subject to 8 week lead time. Extended lead times may apply to Chocolate, Fuchsia, Mint, Mocha and Yellow.

Cascade[®] Maker Table

Available with totes or shelves. Or both.

NEW!



Cascade Maker Table

The all-new Cascade Maker Table combines up time and down time in one convenient system. The broad surface and ample storage help you re-imagine the ease and efficiency of your Maker space in a simple, mobile all-in-one unit.

- 1 1/4 inch work surface or 1 3/4" Butcherblock work surface.
- Optional doors with secure and reliable locking mechanism.
- Fully hinged doors articulate 270 degrees, free of obstruction.
- 18-gauge steel construction, formed and welded to support the entire weight of the unit squarely.
- Standard with peg-board end panels.



Model 25300BUTCHER

Shown with 48" x 48" Butcherblock top with 15 3" tote configuration.

 1 3/4" birchwood. BUTCHER to follow Model No.

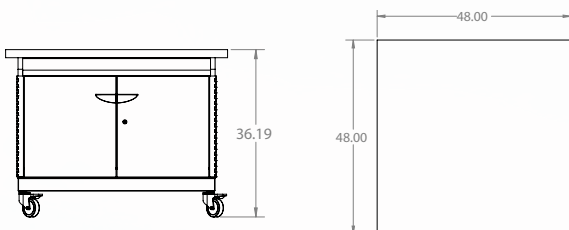



Model 25300F

Cascade Maker Table is 36" in height and features a 48" x 48" worksurface. Shown in Whiteboard top with North Sea edge.

Model	Description	D"	W"	H"	F.C.	Cube	WT.	List Price
25300F	48x48, 30 3" totes, no doors	48	48	36	125	18	280	\$ 4,200.00
25300BUTCHER	48x48, 30 3" totes, no doors	48	48	36	125	18	295	\$ 4,795.00
25301F	48x48, 30 3" totes, w/doors	48	48	36	125	18	310	\$ 4,600.00
25301BUTCHER	48x48, 30 3" totes, w/doors	48	48	36	125	18	325	\$ 5,195.00
25302F	48x48, shelves, no doors	48	48	36	125	18	264	\$ 3,000.00
25302BUTCHER	48x48, shelves, no doors	48	48	36	125	18	279	\$ 3,595.00
25303F	48x48, shelves, w/doors	48	48	36	125	18	292	\$ 3,400.00
25303BUTCHER	48x48, shelves, w/doors	48	48	36	125	18	307	\$ 3,995.00
25304F	48x48, shelves & 15 SW totes, no doors	48	48	36	125	18	272	\$ 3,800.00
25304BUTCHER	48x48, shelves & 15 SW totes, no doors	48	48	36	125	18	287	\$ 4,395.00
25305F	48x48, shelves & 15 SW totes, w/doors	48	48	36	125	18	301	\$ 4,200.00
25305BUTCHER	48x48, shelves & 15 SW totes, w/doors	48	48	36	125	18	316	\$ 4,795.00

Cascade Maker Table Has TWO Top Options



1 1/4" top with 3mm flat edge.
F to follow Model No.



1 3/4" birchwood.
BUTCHER to follow Model No.

Cascade Maker Table Laminate Color Choice

● Pewter Mesh **PEW**
w/matching 3mm edge

● Mission Maple **MIM**
w/matching 3mm edge

● Whiteboard **FWB***
w/Grey [North Sea] 3mm edge

Pegboard End Panels

● Platinum **PEG-BOARD**

* Whiteboard laminate top, add \$125 to list price.

Cascade® Whiteboard



Add \$195 list
Available on any Mega-Tower or Mega-Cabinet Unit.

Optional Whiteboard Back

To specify a whiteboard back to any Cascade Mega-Tower or Mega-Cabinet simply add \$215 to the list price and add a "W" to the 4th position in its model number. See below examples.

Model	Description	D"	W"	H"	F.C.	Wt.	List Price
Add "W" to fourth position and add \$195 to list price to specify whiteboard back.							
Cascade Mega-Towers							
911W00000P_	Open w/shelves w/whiteboard back	19	43	61.4	100	134	\$ 1,456.00
921W00000P_	Doors w/shelves w/whiteboard back	19	43	61.4	100	167	\$ 1,761.00
Cascade Mega-Cabinets							
B11W00000P_	Open w/shelves w/whiteboard back	19	43	43.3	100	105	\$ 1,410.00
B21W00000P_	Doors w/shelves w/whiteboard back	19	43	43.3	100	124	\$ 1,428.00

Cascade End Panel and Edge Color Choice

● Apple A	● Burgundy D	● Charcoal R	● Forest Green F	● Mocha T	● Persian Blue J	● Red L
● Black B	● Cerulean S	● Chocolate Q	● Fuchsia G	● Navy I	● Platinum P	● Yellow N
● Blueberry C	● Champagne O*	● Clementine E	● Mint H	● Orange U	● Purple K	

View all finish options on page 271. *Champagne edge color only.

10 day lead time for orders of 20 or less. 21 or more subject to 8 week lead time. Extended lead times may apply to Chocolate, Fuchsia, Mint, Mocha and Yellow.

Cascade Two-Sided Whiteboard Unit



Smith System is helping educators maximize their shrinking learning environments by introducing the new Cascade Two-Sided Whiteboard Unit. This versatile, nomadic workhorse replaces the traditional single-purpose whiteboard with a dual-purpose mobile whiteboard plus storage. Key features include magnetic writing surfaces on the front and back of a storage unit which houses customizable, extra-wide totes.

The classroom just became more flexible than ever.

- Platinum Only



Model	Description	D"	W"	H"	F.C.	Wt.	List Price
H1003000PP	Cascade Two-Sided Whiteboard Unit w/30 3" EW totes	21	43	70	125	290	\$3,200.00
H10000140PP	Cascade Two-Sided Whiteboard Unit w/14 6" EW totes	21	43	70	125	270	\$3,100.00

Model H1003000PP



Model 210T10000P_S
Shown with ten 3" EW totes in Cerulean Blue.

Cascade Mid-Case Spiral Noteboard

The Spiral Noteboard is available in many configurations, making the cabinet completely customizable to your needs. The spiral noteboard includes a write-on surface with a decorative spiral topper. End panels are finished in your choice of 19 colors.

Model	Description	D"	W"	H"	F.C.	Wt.	List Price
Spiral Noteboard w/shelves							
211T00000P_	Spiral Noteboard. Open w/shelves	19	29	70.75	100	78	\$ 1,299.00
221T00000P_	Spiral Noteboard. Doors w/shelves	19	29	70.75	100	89	\$ 1,429.00
Spiral Noteboard w/totes							
210T10000P_	Spiral Noteboard. Open w/ten 3" SW totes	19	29	70.75	100	84	\$ 1,499.00
220T10000P_	Spiral Noteboard. Doors w/ten 3" SW totes	19	29	70.75	100	95	\$ 1,629.00
210T06020P_	Spiral Noteboard. Open w/six 3" & two 6" SW totes	19	29	70.75	100	85	\$ 1,479.00
220T06020P_	Spiral Noteboard. Doors w/six 3" & two 6" SW totes	19	29	70.75	100	96	\$ 1,609.00

Cascade End Panel and Edge Color Choice

● Apple A	● Burgundy D	● Charcoal R	● Forest Green F	● Mocha T	● Persian Blue J	● Red L
● Black B	● Cerulean S	● Chocolate Q	● Fuchsia G	● Navy I	● Platinum P	● Yellow N
● Blueberry C	● Champagne O*	● Clementine E	● Mint H	● Orange U	● Purple K	

View all finish options on page 271. *Champagne edge color only.

10 day lead time for orders of 20 or less. 21 or more subject to 8 week lead time. Extended lead times may apply to Chocolate, Fuchsia, Mint, Mocha and Yellow.

Cascade® Optional Configurations



Cascade Mega-Tower & Mega-Cabinet with Totes & Shelves

Cascade Mega-Cabinet and Mega-Tower models are now available with a combination tote and shelf configuration. The Cabinet comes with two shelves and 8 totes, the Tower three shelves and 12 totes. Available in all 19 colors.

912012000P_S Mega-Tower
Shown in Cerulean Blue.

612008000P_A Mega-Cabinet
Shown in Apple.

Model	Description	D"	W"	H"	F.C.	Wt.	List Price
Cascade Mega-Towers							
912012000P_	Open w/twelve 3" SW totes & shelves	19	43	61.4	100	134	\$ 1,950.00
922012000P_	Doors w/twelve 3" SW totes & shelves	19	43	61.4	100	167	\$ 2,340.00
Cascade Mega-Cabinets							
612008000P_	Open w/eight 3" SW totes & shelves	19	43	43.3	100	105	\$ 1,590.00
622008000P_	Doors w/eight 3" SW totes & shelves	19	43	43.3	100	124	\$ 1,870.00
Add "W" to fourth position and add \$195 to list price to specify whiteboard back.							



Whiteboard Back Available on Mega-Tower & Mega-Cabinets. See Page 244 for Details.

Cascade End Panel and Edge Color Choice

● Apple A	● Burgundy D	● Charcoal R	● Forest Green F	● Mocha T	● Persian Blue J	● Red L
● Black B	● Cerulean S	● Chocolate Q	● Fuchsia G	● Navy I	● Platinum P	● Yellow N
● Blueberry C	● Champagne O*	● Clementine E	● Mint H	● Orange U	● Purple K	

View all finish options on page 271. *Champagne edge color only.

10 day lead time for orders of 20 or less. 21 or more subject to 8 week lead time. Extended lead times may apply to Chocolate, Fuchsia, Mint, Mocha and Yellow.

Cascade End Panels with Peg Board

To specify a peg board end panel to any Cascade simply add \$195 to the list price and add an "H" to the 10th position in its model number. See below examples.

● Platinum Only

Shown from left to right:
 Mega-Case #310015000H
 Mega-Cabinet #610024000H
 Mega-Tower #910036000H

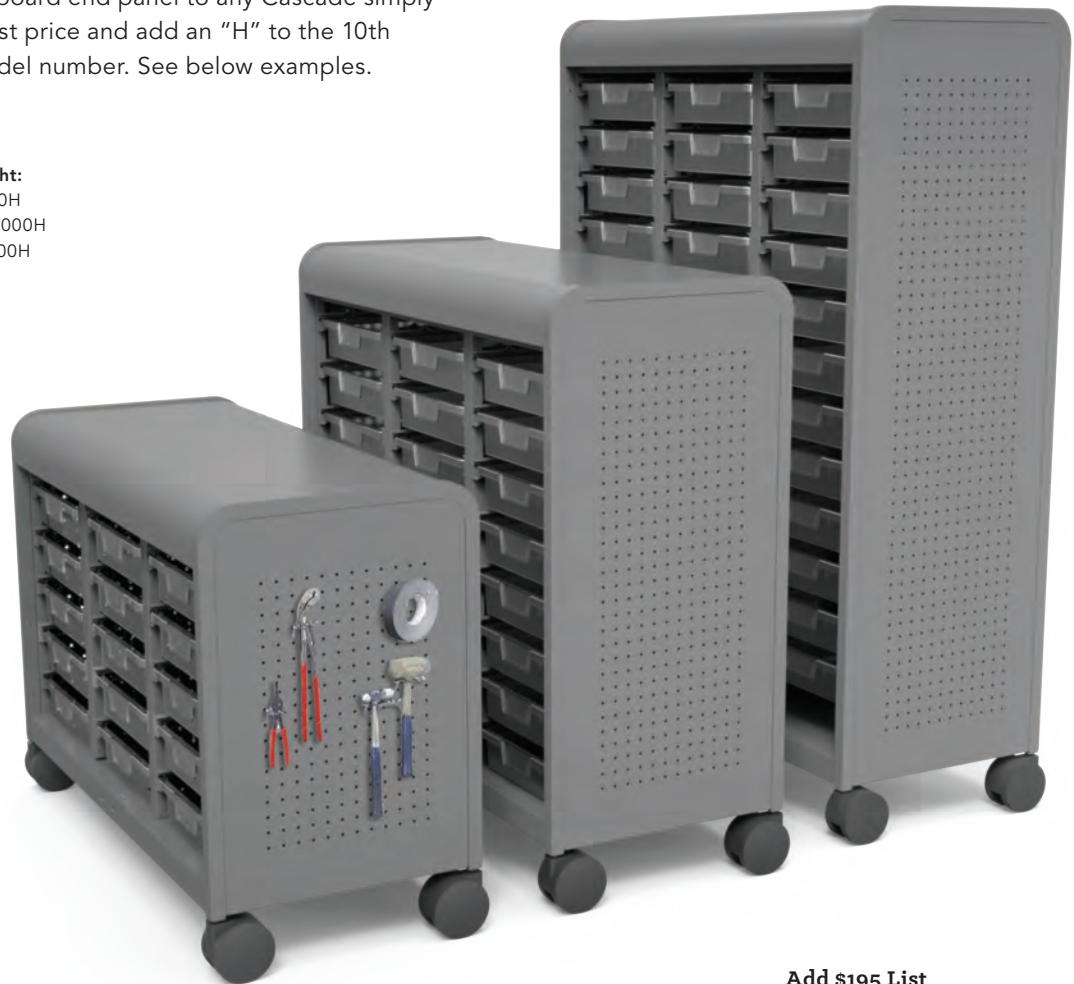

Add \$195 List
 Available on any Cascade unit.

Model	Description		D"	W"	H"	F.C.	Cube	WT.	UPS	List Price
Cascade Case Peg Boards										
110005000H	Mini-Case Open w/five 3" EW totes	w/casters	19	21	30.4	100		52		\$ 940.00
210010000H	Mid-Case Open w/ten 3" SW totes	w/casters	19	29	30.4	100		69		\$ 1,100.00
310015000H	Mega-Case Open w/fifteen 3" SW totes	w/casters	19	43	30.4	100		90		\$ 1,398.00
Cascade Cabinet Peg Boards										
410008000H	Mini-Cabinet Open w/eight 3" EW totes	w/casters	19	21	43.3	100		74		\$ 1,205.00
510016000H	Mid-Cabinet Open w/sixteen 3" SW totes	w/casters	19	29	43.3	100		97		\$ 1,405.00
610024000H	Mega-Cabinet Open w/twenty-four 3" SW totes	w/casters	19	43	43.3	100		132		\$ 1,810.00
Cascade Tower Peg Boards										
710012000H	Mini-Tower Open w/twelve 3" EW totes	w/casters	19	21	61.4	100		96		\$ 1,536.00
810024000H	Mid-Tower Open w/twenty-four 3" SW totes	w/casters	19	29	61.4	100		125		\$ 1,794.00
910036000H	Mega-Tower Open w/thirty-six 3" SW totes	w/casters	19	43	61.4	100		209		\$ 2,329.00

● Platinum Only

Cascade® Cubbies



Cubby Mega-Tower

Cubby Mega-Cabinet

Cubby Mega-Case

Cascade Cubby

These versatile storage units feature large cubbies for organizing backpacks of all sizes, with room left over. They offer the additional benefit of mobility thanks to their 4" or 5" dual-wheel casters. Lockable doors are available as an option, as is a Whiteboard on the Cubby Mega Tower.

The Cascade Cubby combines the quality of ready access you get with shelf storage with the organizational advantages you get with tote storage. Whether used for holding student backpacks or for learning materials, they perform well. Cascade Cubbies are the newest addition to our flexible, scalable, comprehensive solutions for organization, storage and distribution of materials within the school.

- All-steel cabinet rolls on dual-wheel casters: 4" casters for Mega-Case; 5" casters for Mega-Tower and Mega-Cabinet
- Whiteboard back available on Mega-Tower and Mega-Cabinet for + \$195.00 to list price.

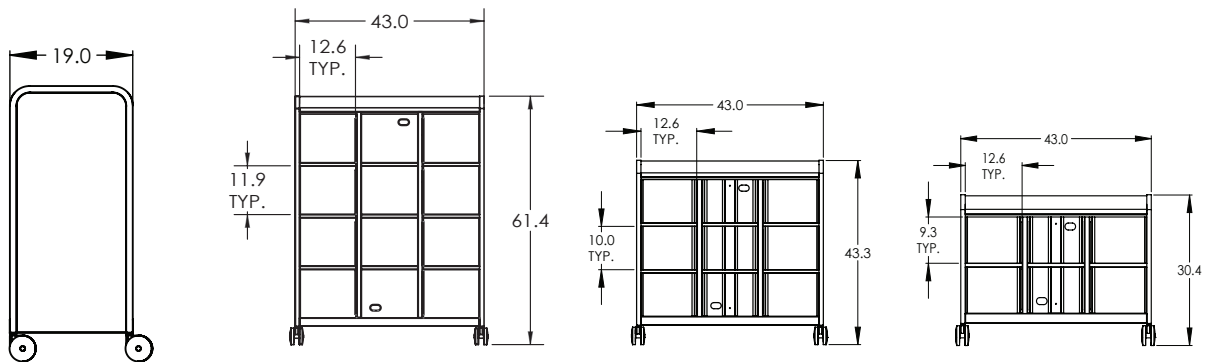

19" depth for all 3 Cubbies

Cubby Mega-Tower

Cubby Mega-Cabinet

Cubby Mega-Case

Flexible, scalable comprehensive storage solutions.



Model F11000000PA
Cascade Cubby Mega-Tower
Shown in Apple.



Model E11000000PC
Cascade Cubby Mega-Cabinet
Shown in Blueberry.



Model D11000000PE
Cascade Cubby Mega-Case
Shown in Clementine.

Cascade Cubby

Model	Description	D"	W"	H"	F.C.	Cube	WT.	UPS	List Price
Cascade Cubby Mega-Tower									
F11000000P_	Open w/12 Cubbies	w/casters	19	43	61.4	100	135		\$ 1,755.00
F21000000P_	Doors w/12 Cubbies	w/casters	19	43	61.4	100	154		\$ 2,059.00
F31000000P_	Open w/12 Cubbies	w/glides	19	43	56.4	100	132		\$ 1,727.00
F41000000P_	Doors w/12 Cubbies	w/glides	19	43	56.4	100	151		\$ 2,032.00
Cascade Cubby Mega-Cabinet									
E11000000P_	Open w/9 Cubbies	w/casters	19	43	43.4	100	128		\$ 1,425.00
E21000000P_	Doors w/9 Cubbies	w/casters	19	43	43.4	100	147		\$ 1,637.00
E31000000P_	Open w/9 Cubbies	w/glides	19	43	38.4	100	125		\$ 1,397.00
E41000000P_	Doors w/9 Cubbies	w/glides	19	43	38.4	100	144		\$ 1,609.00
Cascade Cubby Mega-Case									
D11000000P_	Open w/6 Cubbies	w/casters	19	43	30.4	100	97		\$ 1,095.00
D21000000P_	Doors w/6 Cubbies	w/casters	19	43	30.4	100	111		\$ 1,247.00
D31000000P_	Open w/6 Cubbies	w/glides	19	43	25.4	100	94		\$ 1,067.00
D41000000P_	Doors w/6 Cubbies	w/glides	19	43	25.4	100	108		\$ 1,220.00



Whiteboard Back available for Mega-Cabinet & Mega-Tower size, + \$195 to list price
Add W__ to 4th character to order. Example on page 244.

Cascade End Panel and Edge Color Choice

● Apple A	● Burgundy D	● Charcoal R	● Forest Green F	● Mocha T	● Persian Blue J	● Red L
● Black B	● Cerulean S	● Chocolate Q	● Fuchsia G	● Navy I	● Platinum P	● Yellow N
● Blueberry C	● Champagne O*	● Clementine E	● Mint H	● Orange U	● Purple K	

View all finish options on page 271. *Champagne edge color only.

10 day lead time for orders of 20 or less. 21 or more subject to 8 week lead time. Extended lead times may apply to Chocolate, Fuchsia, Mint, Mocha and Yellow.



Cascade Maker Cart

This maker cart provides movable, lockable storage for AV equipment, and a durable work surface. Available in 19 colors. Locking doors open 270° to provide obstruction-free access to AV gear and materials.

- Ventilation ports to help cool electronic devices and projectors.
- Cord and access ports located on back.
- Total of four electrical outlets outside and five inside connected with one 12 foot cord.
- Rolls smoothly on 4" double-wheel casters.
- 16.5" x 40.5" inside shelf included
- Includes apparatus rod or 'filament spool holder.'

Model V21U00000P **B ANGL**

Cascade Mega-Case Maker Cart. Shown in Black End Panel & Red Door Handle. Riser Shelf shown in Asian Night Laminate top color with Red edge color.

(See Image on opposite page for reverse side, Cascade AV Presentation Cart.)

Model	Description	D"	W"	H"	F.C.	Cube	Wt.	List Price
V21U00000P_ _ _ _ _	Cascade Mega-Case Maker Cart	19	43	37	100	22.7	125	\$ 2,475.00



Model V21100000PG TAC G
Cascade AV Mega-Case



Model V21100000PG TAC G
Cascade AV Mega-Case,
(Back panel identical for Maker
Cart on opposite page.)

Cascade AV Presentation Cart

This presentation cart provides movable, lockable storage for AV equipment, and a durable work surface. Available in 19 colors. Locking doors open 270° to provide obstruction-free access to AV gear and materials.

- Ventilation ports to help cool electronic devices and projectors.
- Cord and access ports located on back.
- Total of four electrical outlets outside and five inside connected with one 12 foot cord.
- Rolls smoothly on 4" double-wheel casters.
- 16.5 x 40.5" inside shelf included



Model W21100000PS TAC S
Cascade AV Mid-Case

Model	Description	D"	W"	H"	F.C.	Cube	Wt.	List Price
V21100000P_ _ _ _	Cascade Mega-Case AV Presentation Cart	19	43	37	100	22.7	125	\$ 2,145.00
W21100000P_ _ _ _	Cascade Mid-Case AV Presentation Cart	19	29	37	100		98	\$ 1,925.00

Cascade Laminate Color Choice

- Asian Night **ANG**
- Boardwalk Oak **BWK**
- Pewter Mesh **PEW**
- Classic Linen **CLN**
- High Rise **HRE**
- Buka Bark **BBK**
- Palisades Oak **PSO**
- Flax Linen **FLL**
- Mission Maple **MIM**
- New Age Oak **NEW**
- Wild Cherry **CHE**
- Fusion Maple **MAP**
- Grey Nebula **GNB**
- French Pear **FRP**

Cascade End Panel and Edge Color Choice

- Apple **A**
- Black **B**
- Blueberry **C**
- Burgundy **D**
- Cerulean **S**
- Champagne **O***
- Charcoal **R**
- Chocolate **Q**
- Clementine **E**
- Forest Green **F**
- Fuchsia **G**
- Mint **H**
- Mocha **T**
- Navy **I**
- Orange **U**
- Persian Blue **J**
- Platinum **P**
- Purple **K**
- Red **L**
- Yellow **N**

View all finish options on page 271. *Champagne edge color only.

10 day lead time for orders of 20 or less. 21 or more subject to 8 week lead time. Extended lead times may apply to Chocolate, Fuchsia, Mint, Mocha and Yellow.

Lessen the footprint of your teacher's area.
Conveniently store the essentials.



Model R10006062PP
Cascade Teacher Wardrobe with casters.
Open with SW totes.



Available with
locking doors.

Model L10024000PE
Cascade Teacher Wardrobe with casters.
Open with SW totes.

Cascade Teacher Wardrobe with totes

This high-capacity, versatile, mobile storage unit is available with tote trays and a shelf and can be fitted with optional locking doors. Our Cascade Storage System allows educators to organize, store and distribute learning materials. This mobile storage unit is highly customizable to hold items in a wide range of sizes and shapes — from daily assignments to art supplies.

Whiteboard Back
available for
Mega-Tower size,
+\$ 215 to list price
Add W__ to 4th
character to order.
Example:
R10W24000P_

Model	Description		D"	W"	H"	F.C.	Wt.	List Price
Right-hand	Standard Width (SW) Totes							
R10024000P_	Open w/twenty-four 3" SW totes	w/casters	19	43	61.4	100	147	\$ 1,878.00
R20024000P_	Doors w/twenty-four 3" SW totes	w/casters	19	43	61.4	100	179	\$ 2,212.00
R10000120P_	Open w/twelve 6" SW totes	w/casters	19	43	61.4	100	147	\$ 1,749.00
R10006062P_	Open w/six 3" and six 6" and two 12" SW totes	w/casters	19	43	61.4	100	147	\$ 1,785.00
R20000120P_	Doors w/twelve 6" SW totes	w/casters	19	43	61.4	100	179	\$ 2,085.00
R20006062P_	Doors w/six 3" and six 6" and two 12" SW totes	w/casters	19	43	61.4	100	179	\$ 2,121.00

Note: *Specify whether you would like shelf/wardrobe on Left or Right. Model numbers for Left-hand Shelf begin with L.

Standard Width (SW) Tote



66000 16 3/4"d x 12 1/4"w x 3"h
66001 16 3/4"d x 12 1/4"w x 6"h
66002 16 3/4"d x 12 1/4"w x 12"h

Extra Wide (EW) Tote



66010 16 5/8"d x 18 3/8"w x 3"h
66011 16 5/8"d x 18 3/8"w x 6"h

Model	Description	D"	W"	H"	F.C.	Cube	WT.	UPS	List Price
Totes with Housing*									
30925	SW (Standard Width) housing with tote	16.8	13.5	3	70		8		\$ 93.00
30926	EW (Extra Wide) housing with tote	16.8	19.6	3	70		10		\$ 103.00
30927	SW (Standard Width) housing only				70		2		\$ 55.00
30928	EW (Extra Width) housing only				70		3		\$ 69.00
Interchange Totes with Standard Width Housing*									
66013	Interchange SW (Standard Width) Tote Tray w/housing								\$ 88.00
66014	Interchange SW (Standard Width) housing only								\$ 68.00
Standard Width Totes*									
66000	SW Single Depth tote Clear 3"	16.8	12.3	3	70		4		\$ 20.00
66001	SW Double Depth tote Clear 6"	16.8	12.3	6	70		6		\$ 29.00
66002	SW Quad Depth tote Clear 12"	16.8	12.3	12	70		8		\$ 47.00
Extra Wide Totes*									
66010	EW Single Depth tote Clear	16.6	18.4	3	70		5		\$ 36.00
66011	EW Double Depth tote Clear	16.6	18.4	6	70		7		\$ 47.00
Tote Lids									
66020	SW tote lid	16.8	13.5	1	70		2		\$ 17.00
66021	EW tote lid	16.6	18.4	1	70		3		\$ 20.00
66030	Plastic Label Cover (Avery® Label sold separately. #5162)								\$ 2.00
*See tote compatibility chart on page 209 for which desks work.									

Standard Width (SW) Tote

with Lid (66020) & Label Cover (66030)



Extra Wide (EW) Tote

with Lid (66021) & Label Cover (66030)



Laptop Shelf

Optional Laptop Shelf
 Model 17670 PLT \$130.00

Cascade End Panel and Edge Color Choice

- Apple A
- Burgundy D
- Charcoal R
- Forest Green F
- Mocha T
- Persian Blue J
- Red L
- Black B
- Cerulean S
- Chocolate Q
- Fuchsia G
- Navy I
- Platinum P
- Yellow N
- Blueberry C
- Champagne O*
- Clementine E
- Mint H
- Orange U
- Purple K

View all finish options on page 271. *Champagne edge color only.

Cascade® Teacher Desks

The Teacher's Desk for the 21st Century.





Single Cabinet



Double Cabinet



Single Bullet Cabinet



Double Bullet Cabinet



P-Top Single Cabinet



P-Top



Bullet



Rectangle



Double Bullet

The teacher’s role has evolved from transmitting knowledge and maintaining order to facilitating learning and managing learning materials.

That’s why the teacher’s equipment has evolved, too.

Developed in anticipation of these 21st Century needs, the Cascade Teacher’s Desk makes use of Cascade Totes that can be transferred directly to Cascade Storage Units and properly equipped student desks. This allows the Teacher’s desk to be the central hub in managing projects and learning materials.



Transfer from cabinet.

Totes from the Cascade Wardrobe can be removed and distributed as needed.



Transfer to teacher’s desk.

Totes holding materials needed for the day’s lesson can be moved to the pedestal.

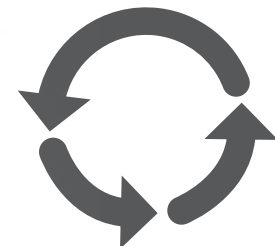

Transfer to student.

Totes can be distributed to students’ desks.

Cascade® Teacher Desks



Cascade mini-case, lectern page 232



21096 Book Truck See page 268



Cascade Mega-tower See page 239

The essentials for teacher success.

smithsystem.com/furniture-types/teacher



Theorem Mobile
Stack Chair
See page 42

Cascade Teacher Desk
See page 264

Cascade® Teacher Desks



Model 26159

Shown in Grey Nebula top with Orange edge and Platinum frame. Paired with an optional Cascade Mini-Case with Riser unit in Orange.



Model 26140

Shown in Fusion Maple top with Forest Green edge and Platinum frame.



Model 26151

Shown in New Age Oak top with Platinum edge and Platinum frame with Thorem® mobile chair, Model 44815.

Cascade Teacher Desks, Single Cabinet

The Cascade Teacher Desk offers a stable, mobile and versatile workspace, integrated wire manager and modesty panel and great ingress/egress plus the unique capabilities of Cascade Storage, a scalable solution for organization, storage and distribution of learning materials. Locate the pedestal on the left or right side; its drawers are Cascade Totes. 1 1/4" top with Bumper T-Mold. Choose from 14 standard laminate colors and 20 standard edge colors. Platinum or Black frame.

Model	Description		D"	W"	H"	F.C.	Cube	Wt.	UPS	List Price
Pedestal										
26158	Teacher Desk – Box/Box/File	Left-hand	24	54	30.25	70		142		\$ 905.00
26159	Teacher Desk – Box/Box/File	Right-hand	24	54	30.25	70		142		\$ 905.00
26140	P-Top Teacher Desk – Box/Box/File	Right-hand	24	60	30.25	70		150		\$ 982.00
26141	P-Top Teacher Desk – Box/Box/File	Left-hand	24	60	30.25	70		150		\$ 982.00
Standard Width (SW) Totes										
26150	Open w/six 3" SW totes	Left-hand	24	54	30.25	70		122		\$ 869.00
26151	Open w/six 3" SW totes	Right-hand	24	54	30.25	70		122		\$ 869.00
26152	Door w/six 3" SW totes	Left-hand	24	54	30.25	70		129		\$ 976.00
26153	Door w/six 3" SW totes	Right-hand	24	54	30.25	70		129		\$ 976.00
26154	Open w/two 3" and one 12" SW totes	Left-hand	24	54	30.25	70		122		\$ 839.00
26155	Open w/two 3" and one 12" SW totes	Right-hand	24	54	30.25	70		122		\$ 839.00
26156	Door w/two 3" and one 12" SW totes	Left-hand	24	54	30.25	70		129		\$ 946.00
26157	Door w/two 3" and one 12" SW totes	Right-hand	24	54	30.25	70		129		\$ 946.00



Model 19198

Model 19199

Model	Description	D"	W"	H"	List Price
Cascade Free Standing Drawer Pedestals					
19195	Drawer Ped Open w/top and six 3" SW totes	21	16	30.25	\$ 470.00
19196	Drawer Ped Open w/top and two 3" and one 12" SW totes	21	16	30.25	\$ 440.00
19197	Drawer Ped w/door and top and six 3" SW totes	21	16	30.25	\$ 584.00
19198	Drawer Ped w/door and top and two 3" and one 12" SW totes	21	16	30.25	\$ 553.00
19199	Box/Box/File Pedestal	21	16	29	\$ 506.00
19201	File/File Pedestal	21	16	29	\$ 506.00

Cascade Teacher Desks Have Top and Edge Choices



CHOICE 1 – 1 1/4" top with Bumper T-Mold
no letter to follow Model No.



CHOICE 2 – 1 1/4" top with 4mm T-Mold
D to follow Model No.

Cascade Laminate Color Choice

- Asian Night **ANG**
- Pewter Mesh **PEW**
- Palisades Oak **PSO**
- New Age Oak **NEW**
- Grey Nebula **GNB**
- Boardwalk Oak **BWK**
- High Rise **HRE**
- Flax Linen **FLL**
- Wild Cherry **CHE**
- French Pear **FRP**
- Classic Linen **CLN**
- Buka Bark **BBK**
- Mission Maple **MIM**
- Fusion Maple **MAP**

Frame Color

- Platinum
- Black

Cascade Edge Color Choice

- Apple **A**
- Burgundy **D**
- Charcoal **R**
- Forest Green **F**
- Mocha **T**
- Persian Blue **J**
- Red **L**
- Black **B**
- Cerulean **S**
- Chocolate **Q**
- Fuchsia **G**
- Navy **I**
- Platinum **P**
- Yellow **N**
- Blueberry **C**
- Champagne **O**
- Clementine **E**
- Mint **H**
- Orange **U**
- Purple **K**

View all finish options on page 271.

Cascade® Teacher Desks

Cascade Teacher Desks, Double Cabinet

The Cascade Teacher Desk offers a stable, mobile and versatile workspace, integrated wire manager and modesty panel and great ingress/egress plus the unique capabilities of Cascade Storage, a scalable solution for organization, storage and distribution of learning materials. The two pedestals' drawers are Cascade totes. 1 1/4" top with Bumper T-Mold. Choose from 14 standard laminate colors and 20 standard edge colors. Platinum or Black frame.



Model 26173. Shown in non-standard Blond Echo top with Persian Blue edge and Platinum frame.



Model 26171. Shown in non-standard Blond Echo top with Persian Blue edge and Platinum frame.



Model 26174. Shown in Wild Cherry top with Black edge and Platinum frame.



Model 26177. Shown in non-standard Blond Echo top with Persian Blue edge and Platinum frame.



Model 26178
Shown with Non-standard
Amber Cherry top, Black edge
and Platinum frame.

Model	Description	D"	W"	H"	F.C.	Cube	Wt.	UPS	List Price
Standard Width (SW) Totes									
26170	Open w/twelve 3" SW totes	24	67	30.25	70		153		\$ 1,097.00
26171	Open w/four 3" and two 12" SW totes	24	67	30.25	70		153		\$ 1,145.00
Standard Width (SW) Totes & Pedestal									
26172	Open w/six 3" totes & Box/Box/File pedestal	24	67	30.25	70		173		\$ 1,262.00
26173	Open w/two 3", one 12" tote and Box/Box/File pedestal	24	67	30.25	70		173		\$ 1,212.00
Standard Width (SW) Totes									
26174	Door w/twelve 3" totes	24	67	30.25	70		167		\$ 1,433.00
26175	Door w/four 3" and two 12" totes	24	67	30.25	70		167		\$ 1,371.00
Standard Width (SW) Totes & Pedestal									
26176	Door w/six 3" totes & Box/Box/File pedestal	24	67	30.25	70		180		\$ 1,374.00
26177	Door w/two 3", one 12" tote & Box/Box/File pedestal	24	67	30.25	70		180		\$ 1,326.00
Pedestals									
26178	Two Box/Box/File pedestals	24	67	30.25	70		193		\$ 1,278.00
26188	One File/File & One Box/Box/File pedestal	24	67	30.25	70		193		\$ 1,278.00

Cascade Teacher Desks Have Top and Edge Choices

1 1/4" Tops

CHOICE 1 – 1 1/4" top with Bumper T-Mold no letter to follow Model No.

CHOICE 2 – 1 1/4" top with 4mm T-Mold **D** to follow Model No.

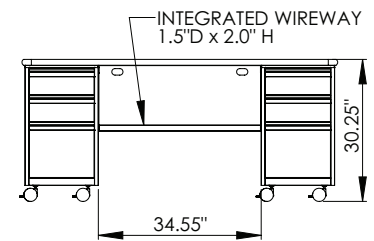
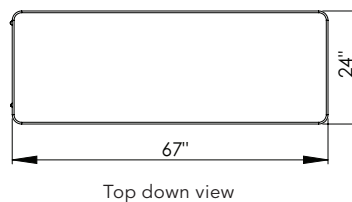

Cascade Laminate Color Choice

- Asian Night **ANG**
- Pewter Mesh **PEW**
- Palisades Oak **PSO**
- New Age Oak **NEW**
- Grey Nebula **GNB**
- Boardwalk Oak **BWK**
- High Rise **HRE**
- Flax Linen **FLL**
- Wild Cherry **CHE**
- French Pear **FRP**
- Classic Linen **CLN**
- Buka Bark **BBK**
- Mission Maple **MIM**
- Fusion Maple **MAP**

Frame Color

- Platinum
- Black

Cascade Edge Color Choice

- Apple **A**
- Burgundy **D**
- Charcoal **R**
- Forest Green **F**
- Mocha **T**
- Persian Blue **J**
- Red **L**
- Black **B**
- Cerulean **S**
- Chocolate **Q**
- Fuchsia **G**
- Navy **I**
- Platinum **P**
- Yellow **N**
- Blueberry **C**
- Champagne **O**
- Clementine **E**
- Mint **H**
- Orange **U**
- Purple **K**

View all finish options on page 271.

Cascade® Teacher Desks



Model 26161. Shown in Fusion Maple top with Red edge and Platinum frame.

Cascade Teacher Desks, Single Bullet Cabinet

The Cascade Teacher Desk offers a stable, mobile and versatile workspace, integrated wire manager and modesty panel and great ingress/egress plus the unique capabilities of Cascade Storage, a scalable solution for organization, storage and distribution of learning materials. Three drawers: Box/Box/File. 1 1/4" top with Bumper T-Mold. Choose from 14 standard laminate colors and 20 standard edge colors. Platinum or Black frame.

- Work surface is rugged high-pressure laminate.
- Fully welded 20-gauge steel frame for durability
- Rolls smoothly on 3" dual wheel casters

Model	Description		D"	W"	H"	F.C.	Cube	Wt.	UPS	List Price
Pedestal										
26160	Teacher Desk w/Box/Box/File ped	Left Hand	24	60	30.25			149		\$ 932.00
26161	Teacher Desk w/Box/Box/File ped	Right Hand	24	60	30.25			149		\$ 932.00

Cascade Teacher Desks Have Top and Edge Choices

- 1 1/4" Tops
- CHOICE 1** – 3/8" Bumper T-Mold – 1 1/4" top with Bumper T-Mold no letter to follow Model No.
- CHOICE 2** – 4mm T-Mold – 1 1/4" top with 4mm T-Mold D to follow Model No.

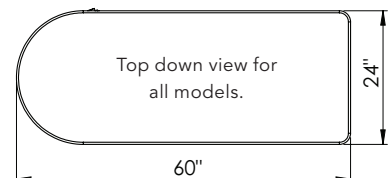



Model 26163. Shown in Fusion Maple top with Red edge and Platinum frame.



Model 26165. Shown in Fusion Maple top with Red edge and Platinum frame.

Model	Description		D"	W"	H"	F.C.	Cube	Wt.	UPS	List Price
Standard Width (SW) Totes										
26162	Open w/two 3" and one 12" totes	Left Hand	24	60	30.25			129		\$ 866.00
26163	Open w/two 3" and one 12" totes	Right Hand	24	60	30.25			129		\$ 866.00
26166	Open w/six 3" totes	Left Hand	24	60	30.25			129		\$ 895.00
26167	Open w/six 3" totes	Right Hand	24	60	30.25			129		\$ 895.00
26164	Door w/two 3" and one 12" totes	Left Hand	24	60	30.25			136		\$ 972.00
26165	Door w/two 3" and one 12" totes	Right Hand	24	60	30.25			136		\$ 972.00
26168	Door w/six 3" totes	Left Hand	24	60	30.25			136		\$ 1,002.00
26169	Door w/six 3" totes	Right Hand	24	60	30.25			136		\$ 1,002.00

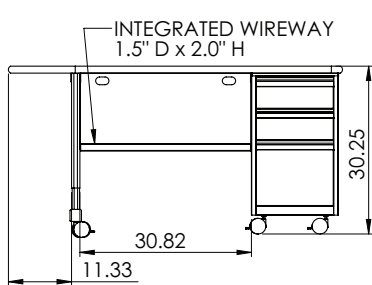

Model 26161

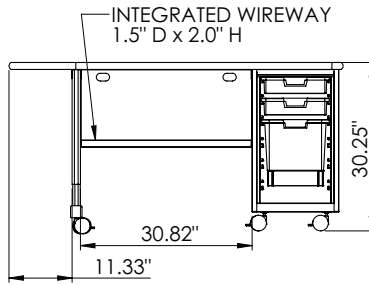

Model 26163

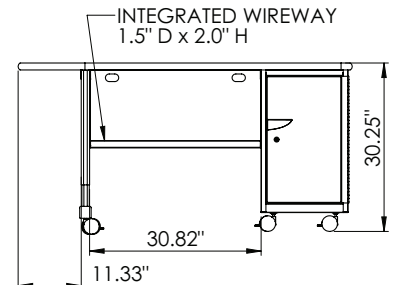

Model 26165

Cascade Laminate Color Choice

- Asian Night **ANG**
- Pewter Mesh **PEW**
- Palisades Oak **PSO**
- New Age Oak **NEW**
- Grey Nebula **GNB**
- Boardwalk Oak **BWK**
- High Rise **HRE**
- Flax Linen **FLL**
- Wild Cherry **CHE**
- French Pear **FRP**
- Classic Linen **CLN**
- Buka Bark **BBK**
- Mission Maple **MIM**
- Fusion Maple **MAP**

Frame Color

- Platinum
- Black

Cascade Edge Color Choice

- Apple **A**
- Burgundy **D**
- Charcoal **R**
- Forest Green **F**
- Mocha **T**
- Persian Blue **J**
- Red **L**
- Black **B**
- Cerulean **S**
- Chocolate **Q**
- Fuchsia **G**
- Navy **I**
- Platinum **P**
- Yellow **N**
- Blueberry **C**
- Champagne **O**
- Clementine **E**
- Mint **H**
- Orange **U**
- Purple **K**

View all finish options on page 271.

Cascade® Teacher Desks

Cascade Teacher Desks, Double Bullet Cabinet

The Cascade Teacher Desk offers a stable, mobile and versatile workspace, integrated wire manager and modesty panel and great ingress/egress plus the unique capabilities of Cascade Storage, a scalable solution for organization, storage and distribution of learning materials. The two pedestals' drawers are Cascade totes. 1 1/4" top with Bumper T-Mold. Choose from 14 standard laminate colors and 20 standard edge colors. Platinum or Black frame.



Model	Description	D"	W"	H"	F.C.	Cube	Wt.	UPS	List Price
Standard Width (SW) Totes									
26182	Open w/twelve 3" totes	28	72	30.25	70		167		\$ 1,246.00
26184	Open Desk w/four 3" & two 12" totes	28	72	30.25	70		167		\$ 1,185.00
26183	Door w/twelve 3" totes	28	72	30.25	70		181		\$ 1,473.00
26185	Door w/four 3" and two 12" totes	28	72	30.25	70		181		\$ 1,411.00
Standard Width (SW) Totes & Pedestal									
26179	Open w/two 3" & one 12" totes & Box/Box/File Pedestals	28	72	30.25			187		\$ 1,252.00
26186	Open w/six 3" & Box/Box/File Pedestals	28	72	30.25			187		\$ 1,301.00
26181	Door w/two 3" totes & one 12" tote & Box/Box/File Pedestals	28	72	30.25			194		\$ 1,365.00
26187	Door w/six 3" & Box/Box/File Pedestals	28	72	30.25			194		\$ 1,414.00
Pedestal									
26180	Two Box/Box/File Pedestals	28	72	30.25			207		\$ 1,318.00
26194	One File/File & One Box/Box/File	28	72	30.25			207		\$ 1,318.00



Model 19198

Model 19199

Model	Description	D"	W"	H"	List Price
Cascade Free Standing Drawer Pedestals					
19195	Drawer Ped Open w/top and six 3" SW totes	21	16	30.25	\$ 470.00
19196	Drawer Ped Open w/top and two 3" and one 12" SW totes	21	16	30.25	\$ 440.00
19197	Drawer Ped w/door and top and six 3" SW totes	21	16	30.25	\$ 584.00
19198	Drawer Ped w/door and top and two 3" and one 12" SW totes	21	16	30.25	\$ 553.00
19199	Box/Box/File Pedestal	21	16	29	\$ 506.00
19201	File/File Pedestal	21	16	29	\$ 506.00

Cascade Teacher Desks Have Top and Edge Choices

1 1/4" Tops



CHOICE 1 – 1 1/4" top with Bumper T-Mold
no letter to follow Model No.



CHOICE 2 – 1 1/4" top with 4mm T-Mold
D to follow Model No.

Cascade Laminate Color Choice						Frame Color
● Asian Night ANG	● Pewter Mesh PEW	● Palisades Oak PSO	● New Age Oak NEW	● Grey Nebula GNB		● Platinum
● Boardwalk Oak BWK	● High Rise HRE	● Flax Linen FLL	● Wild Cherry CHE	● French Pear FRP		● Black
● Classic Linen CLN	● Buka Bark BBK	● Mission Maple MIM	● Fusion Maple MAP			

Cascade Edge Color Choice						
● Apple A	● Burgundy D	● Charcoal R	● Forest Green F	● Mocha T	● Persian Blue J	● Red L
● Black B	● Cerulean S	● Chocolate Q	● Fuchsia G	● Navy I	● Platinum P	● Yellow N
● Blueberry C	● Champagne O*	● Clementine E	● Mint H	● Orange U	● Purple K	

View all finish options on page 271.



Model 26182
 Shown in non-standard Blond Echo top with
 Cerulean edge and Platinum frame.



Model 26184
 Shown in non-standard Blond Echo top with
 Cerulean edge and Platinum frame.



Model 26179
 Shown in non-standard Blond Echo top with
 Cerulean edge and Platinum frame.



Model 26180
 Shown in non-standard Blond Echo top with
 Cerulean edge and Platinum frame.

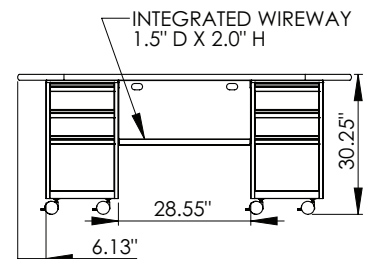
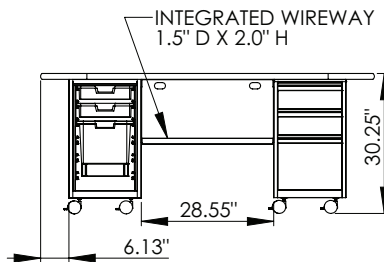
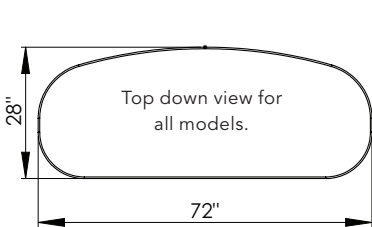



The Cascade Nomad has three shelves accessible from either side. Each shelf is halved by a structural divider.

Cascade® Nomad Cart

Featuring three shelves, the Cascade Nomad offers an open-shelf layout with easy access for maximizing storage in any classroom or library setting. The powder coated all steel construction maximizes durability guaranteeing many years of service. The Nomad unit has a maximum capacity of 800 lbs. and rolls on sturdy, 5" casters for mobility. Cascade Nomad is available in Platinum only.

Model	Description	D"	W"	H"	F.C.	Cube	WT.	UPS	List Price
21900	Cascade Nomad Cart	21	43	53	100	15.0	128		\$ 1,575.00

- Platinum Only



**The Utility Cart
Model 21090**
Shown in Persian Blue.

**The Everything Cart
Model 21088**
Shown in Red.



The Everything Cart has six compartments top and bottom. The Utility Cart has one large compartment top and bottom.

Everything & Utility Carts

These carts are designed for maximum versatility, they roll smoothly on standard 4" soft-tread dual-wheel casters. Or choose optional 5" dual wheel or 5" single-wheel casters. They have two levels of double-face bins that can hold almost anything from books to art supplies, gym equipment and student works.

- Baked-on powder coat finish provides lasting color.
- Choose from 11 colors.
- 18-gauge steel, welded construction.

Model	Description	D"	W"	H"	F.C.	Cube	WT.	UPS	List Price
21088	Everything Cart	18	36	36	150	15.0	70		\$ 528.00
21090	Utility Cart	18	36	36	150	15.0	70		\$ 528.00

Booktruck Color Choice

● Apple	● Cerulean	● Forest Green	● Persian Blue*	● Purple	● Sand*
● Black*	● Clementine	● Navy	● Platinum*	● Red*	

* Quick Ship colors: Black, Persian Blue, Platinum, Red and Sand (up to quantity of 5). All other colors 8 week lead time.

Library Booktrucks



Three Flat Shelf Truck
Model 21051. Shown in Navy.



Gorilla Truck w/Six sloping shelves, Model 21101
Shown in Red. 600-lb. capacity.



Three Sloping Shelf Truck "Mini"
Model 21096 (right)
Shown in Platinum.

Booktrucks

4" soft-tread, dual-wheel casters standard. Optional are 5" dual-wheel or 5" single-wheel. Available in 11 colors.

- Choose from single- or double-sided configurations.
- Baked-on powder coat finish provides lasting color.
- Choose from 11 colors.
- Double-sided models have sloping shelves that are 34" long x 7 1/2" deep on each side and a 6" high back.
- 18-gauge steel, welded construction.

Model	Description	D"	W"	H"	F.C.	Cube	WT.	UPS	List Price
21001*	Six Sloping Shelf Truck	18	36	43	150	17.0	73		\$ 517.00
21004*	Six Sloping Shelf Truck w/6 book supports	18	36	43	150	17.0	76		\$ 569.00
21092	Three Sloping Shelf Truck	14	36	43	150	15.2	60		\$ 377.00
21094	Three Sloping Shelf Truck w/3 book supports	14	36	43	150	15.2	62		\$ 403.00
21096	Three Sloping Shelf Truck	14	24	43	150	12.2	46	*	\$ 376.00
21051*	Three Flat Shelf Truck	18	36	43	150	17.0	62		\$ 444.00
21088*	Everything Cart	18	36	36	150	15.0	70		\$ 528.00
21090*	Utility Cart	18	36	36	150	15.0	70		\$ 528.00
21101*	Gorilla Truck 6 Sloping Shelf w/six 5" casters	18	36	44	150	17.0	89		\$ 628.00

*Accommodates #21109 Booktruck Top

Booktruck Color Choice

- Apple
- Cerulean
- Forest Green
- Persian Blue*
- Purple
- Sand*
- Black*
- Clementine
- Navy
- Platinum*
- Red*

* Quick Ship colors: Black, Persian Blue, Platinum, Red and Sand (up to quantity of 5). All other colors 8 week lead time.



The Everything Cart
Model 21088
 Shown in Apple.



Six Sloping Shelf Truck, Model 21001
 Shown in Cerulean. Optional Shelf Dividers, Model 21104, \$ 26.00



Three Sloping Shelf Truck
Model 21092. Shown in Sand.
 Shown with optional Shelf Dividers, Model 21105, \$ 29.00

Booktruck Accessories



Booktruck Top

This shelf adds utility. For Smith System 36" booktrucks, it includes pole supports in Platinum. Choose from all 14 laminate colors and 20 edge colors. To assure maximum strength, only the 1 1/4" thick top is available.

Shown in non-standard Golden Oak with Red edge.

Model	Description	D"	W"	H"	F.C.	Cube	WT.	UPS	List Price
21109	Booktruck Top	18	38	1.25			35		\$ 249.00



Black



Smoke

Booktruck Sliding Shelf Divider

Helps keep books in place and limit shifting. Available in 3 pack. Choose Black or Smoke.

Model	Description	D"	W"	H"	F.C.	Cube	WT.	UPS	List Price
21104	Dividers for models 21001-21031	7		6	70	0.1	2	*	\$ 26.00
21105	Dividers for models 21092-21096	10		6	70		2	*	\$ 29.00

Booktruck Caster Options



4" Dual-wheel Casters
 4 pack. Soft thread.
No-locking wheels
 17560 \$65.00
2-locking wheels
 17565 \$75.00



5" Dual-wheel Casters
 4 pack. Soft thread.
No-locking wheels
 17566 \$90.00
2-locking wheels
 17567 \$103.00



5" Single-wheel Casters
 4 pack. Rubber wheel.
No-locking wheels
 17568 \$101.00
2-locking wheels
 17569 \$118.00

Color Outside the Lines.

Color can have an effect on mood, emotion and productivity, which ultimately influences student success. While there is no one-size-fits-all approach to the use of color, consider letting the purpose of the room guide the color scheme selection. With a little bit of thought and planning — and access to the right furniture company — finding furniture that meets the color needs of any space can be done with ease.

See website for application and availability.

Request a Sample Kit

Go online or ask your Smith System dealer to request a sample kit. The kit includes edge molding color samples, laminate top samples, seating color chips and all the other necessary pieces to select your school's furnishings.

Standard Laminates

All 14 of the standard laminates are -60 finish. When a Wilsonart Laminate code includes "Y," "K," "-12," "-78" or "AEON," these are special laminates with an upcharge, even when it contains a "-60" or "-38."

Laminate Options

Want to specify a different laminate? No problem. If you have 20 or more tops of the same color -60 or -38 there is no upcharge. Have 20 or less or want to specify a different laminate brand? We will quote the job for you, just provide the laminate code and finish style.

Design Resources

Smith System furniture is available on all popular specification software, including:

- 20/20
- Revit Files
- Project Matrix
- 2D/3D CAD Files

Standard Edge Profiles

Available in 3/4" and 1 1/4" thicknesses, Smith System tables and desktops give you the option of lending the tops of the room a light or substantial feel. Similarly, our edge band treatments give the choice of curved, bullet or bumper edges.

QuickShip

All 14 standard laminate colors and 20 bumper edge colors are part of the QuickShip program. QuickShip lead time for 20 bumper edge tables and 40 chairs is five business days, though this may extend during the busy summer season. Please call for specific availability. All tops are made to order and not returnable.

Standard Laminate Options

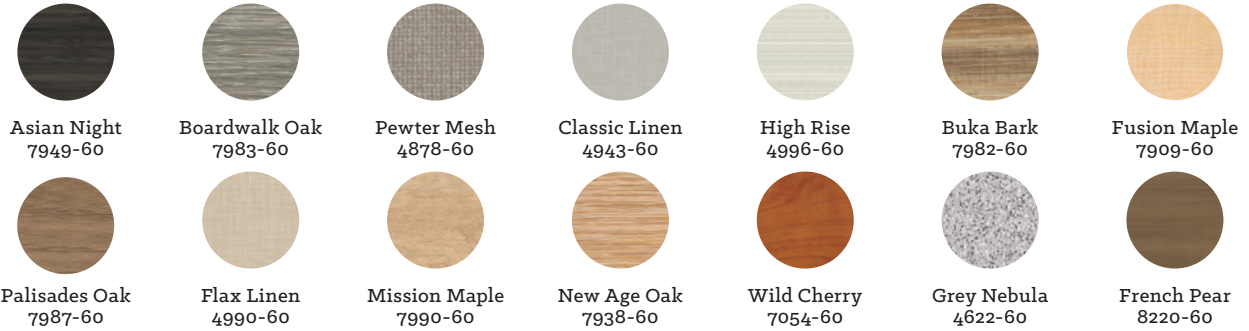

Formica® Markerboard Options

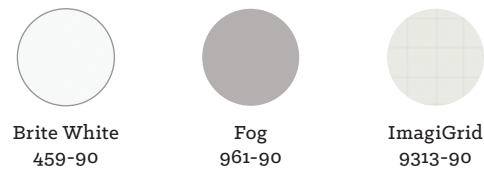

ImagiGrid consists of a 2.5 cm square grid pattern.

Markerboard laminates have a limited 1-year warranty. These laminates are not part of the QuickShip program. \$300 upcharge for markerboard tops. All tops are made to order and not returnable.

Standard Color Options

See product page for application and availability.



Standard Top and Edge Options

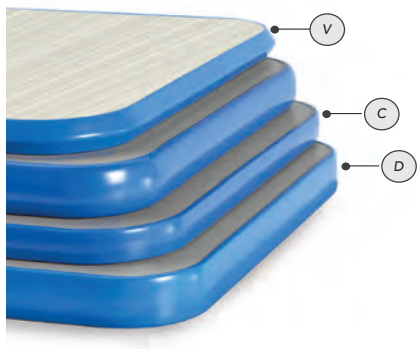

Choice 1		1 1/4" top	3/8" Bumper T-Mold	
Choice 2	(D)	1 1/4" top	4mm T-Mold	
Choice 3	(C)	3/4" top	4mm T-Mold	
Choice 4	(V)	3/4" top	Bullet T-Mold	

Available in 3/4" and 1 1/4" thicknesses. When choosing (D, C, V) of top and edge molding, put the designator at the end of the model number. Example: 04500V = Model 04500 with a 3/4" top and a Bullet T-Mold edge. Consult the specific product page for available options.

Power Options



This symbol indicates you can add power to select tables.



You will find the “ADD POWER” logo throughout this catalog. It signifies which Smith System tables are compatible with our power units.

When ordering, please submit a drawing with your order to indicate the desired positioning of the power unit on the work surface. All power accessories are special order, a custom feature per table and are non-returnable. For more information call 800.328.1061.



Flat Power Module

Shown, Model 017098 SLV
1 power, 1 Twin USB port

Model	Description	D"	W"	H"	UPS	List Price
017098 SLV	1 power, 1 Twin USB port				*	\$ 260.00
017097 SLV	2 power				*	\$ 175.00



Soft Touch Dome Power Module

Shown, Model 017079
BLA 2 power, 1 Twin USB port, 1 power cord

Model	Description	D"	W"	H"	UPS	List Price
017079 BLA	2 power, 1 Twin USB port				*	\$ 245.00
017078 BLA	3 power				*	\$ 160.00



Clamp-On Power Module

4 plug power outlet with
15 ft cord

Model	Description	D"	W"	H"	UPS	List Price
17107	4 power	2.8	6.6	3.3	*	\$ 375.00



Surface Power Module

Shown, Model 017093 SLV
4 power

Model	Description	D"	W"	H"	UPS	List Price
017093 SLV	4 power	3	8	.11	*	\$ 350.00
017086 SLV	2 power, 4 USB	3	8	.11	*	\$ 350.00



Retractable Power Module

Shown, Model 017085 SLV
2 power, 2 Twin USB ports

Model	Description	D"	W"	H"	UPS	List Price
017085 SLV	2 power, 4 USB	4.43	8.25	1.34	*	\$ 495.00
017092 SLV	4 power	4.43	8.25	1.34	*	\$ 495.00



Retractable Mini Power Module

2 power

Model	Description	D"	W"	H"	UPS	List Price
017091 SLV	2 power	3.7	3.7	1.17	*	\$ 250.00

Index

MODEL	DESCRIPTION	PAGE
Oodle® Seating		72-77
OODLE31	Oodle Stool, 3-Piece + 1 Rocker Base	72
OODLE33	Oodle Stool, 3-Piece + 3 Rocker Bases	72
OODLEBASE	Oodle Rocker Base (individual)	72
Lecterns		
04619	Deluxe Table Top Lectern	203
Dual Surface Desktop Lecterns		
00470	Lectern w/Swing Arm, Clamp-On	200
00471	Lectern w/Swing Arm, Bolt-On	200
00472	Lectern w/Spring Loaded Swing Arm, Clamp-On	200
Curl Top Desktop Lecterns		
00480	Lectern w/Swing Arm, Clamp-On	200
00481	Lectern w/Swing Arm, Bolt-On	200
00482	Lectern w/Spring Loaded Swing Arm, Clamp-On	200
In2it® Seating		68-71
00509	18"h In2it Stack Chair - A Shell, powder coat frame	70
00562	16"h In2it Stack Chair - B Shell, powder coat frame	70
00563	14"h In2it Stack Chair - B Shell, powder coat frame	70
72134F	Optional Felt Glide for In2it Stack Chair-set of 4	70
00536	In2it Adj. Chair - A Shell, w/glides	71
00537	In2it Adj. Chair - A Shell, w/casters	71
00532	In2it Adj. Chair - B Shell, w/glides	71
00533	In2it Adj. Chair - B Shell, w/casters	71
00546	In2it Adj. Stool - A Shell, w/glides	71
00547	In2it Adj. Stool - A Shell, w/casters	71
00507	In2it Mobile Chair - A Shell, powder coat frame	71
Plato® Seating		62-67
00950	18"h Plato - A Shell	64
00951	16"h Plato - B+ shell, chrome frame	64
00952	14"h Plato - B Shell, chrome frame	64
00953	18"h Plato Mobile Stack Chair - A Shell	65
00960	Plato Adjustable Chair w/glides - A Shell	67
00961	Plato Adjustable Chair w/casters - A Shell	67
00965	Plato Adjustable Stool w/glides - A Shell	67
00966	Plato Adjustable Stool w/casters - A Shell	67
00967	Plato Cantilever Chair	65
00980	28"h Plato Fixed Height Stool	66
00981	24"h Plato Fixed Height Stool	66
Huddle™ Student Desks		
01265	Huddle-6 Student Desk for 6 student - 6' circle	184
01266	Huddle-8 Student Desk for 8 student - 7' circle	184
01267	Huddle-8LS	184
Planner™ Student Desk		
01272	20" dx27" w Student Desk, Single-Student	186
01279	20" dx32" w Student Desk, Single-Student	186
01274	20" dx36" w Student Desk, Single-Student	186
01285	24" dx27" w Student Desk, Single-Student	186
01286	24" dx36" w Student Desk, Single-Student	186
01276	20" dx48" w Student Desk, Two-Student	187
01278	20" dx54" w Student Desk, Two-Student	187
01280	20" dx60" w Student Desk, Two-Student	187
01284	20" dx72" w Student Desk, Two-Student	187
01287	24" dx48" w Student Desk, Two-Student	187
01288	24" dx54" w Student Desk, Two-Student	187
01289	24" dx60" w Student Desk, Two-Student	187
01290	24" dx72" w Student Desk, Two-Student	187
01295	20" dx84" w Student Desk, Three-Student	188
01296	24" dx84" w Student Desk, Three-Student	188

MODEL	DESCRIPTION	PAGE
Flexline™ Technology Desks		
01377	24" dx60" w Flexline Tech Desk w/Tilt Down Wire Manager	166
01378	24" dx72" w Flexline Tech Desk w/Tilt Down Wire Manager	166
Café Table Bases and Tops: order separately		
01501	30" dx30" w Café Top	213
01502	30" dia. Round Café Top	213
01503	36" dx36" w Café Top	213
01504	36" dia. Round Café Top	213
01506	42" dia. Round Café Top	213
01507	48" dia. Round Café Top	213
Circular Café Bases		
01450	24" dia. Circular Base, coffee table height 16" h	213, 219
01451	24" dia. Circular Base, sitting height table 29" h	213, 219
01452	24" dia. Circular Base, k-8 standing height table 36" h	213, 219
01466	24" dia. Circular Base, working height 40" h	213, 219
01453	24" dia. Circular Base, standing height 42" h	213, 219
01454	30" dia. Circular Base, coffee table height 16" h	213
01455	30" dia. Circular Base, sitting table height 29" h	213
01456	30" dia. Circular Base, k-8 standing height table 36" h	213
01467	30" dia. Circular Base, working height 40" h	213
01457	30" dia. Circular Base, standing height 42" h	213
Crisscross Bases		
01458	24" dia. Crisscross Base, coffee table height 16" h	213, 219
01459	24" dia. Crisscross Base, sitting height table 29" h	213, 219
01460	24" dia. Crisscross Base, k-8 standing height table 36" h	213, 219
01468	24" dia. Crisscross Base, working height 40" h	213, 219
01461	24" dia. Crisscross Base, standing height 42" h	213, 219
01462	30" dia. Crisscross Base, coffee table height 16" h	213
01463	30" dia. Crisscross Base, sitting height table 29" h	213
01464	30" dia. Crisscross Base, k-8 standing height table 36" h	213
01469	30" dia. Crisscross Base, working height 40" h	213
01465	30" dia. Crisscross Base, standing height 42" h	213
Double Café Table, tops only (requires 2 24" dia. bases)		
01520	36" dx72" w Peanut, top only	219
01522	36" dx72" w Racetrack Oval, top only	219
01524	36" dx72" w Rectangle, top only	219
01527	42" dx72" w Double Oval, top only	219
01531	48" dx60" w Multimedia Meeting, top only	216
01555	42" dx72" w Multimedia Meeting, top only	216
Optional Power for Café Tops		
017097	Flat Surface Power Module, 2 Power	213, 219
017098	Flat Surface Power Module, 1 Power 2 USB	213, 219
017078	Soft Touch Power Dome, 3 Power	213, 219
017079	Soft Touch Power Dome, 2 Power, 2 Port USB	213, 219
Silhouette™ Desks		138-151
01600	18" dx24" w Silhouette, Single-Student	158
01602	18" dx24" w Silhouette, Single-Student, fixed-height, w/glides	158
01603	18" dx24" w Silhouette, Single-Student, fixed-height, w/casters	158
01620	22" dx35" w Silhouette Arc Desk, Adjustable Height	160
01621	22" dx35" w Silhouette Arc Desk, fixed-height, w/glides	160
01622	22" dx35" w Silhouette Arc Desk, fixed-height, w/casters	160
01648	20" dx27" w Silhouette, Single-Student, fixed-height, w/casters	158
01649	20" dx27" w Silhouette, Single-Student, fixed-height, w/glides	158
01650	20" dx27" w Silhouette, Single-Student	158
01660	20" dx48" w Silhouette, Two-Student	158
01662	20" dx48" w Silhouette, Two-Student, fixed-height, w/glides	158
01664	20" dx48" w Silhouette, Two-Student, fixed-height, w/casters	158

Index

MODEL	DESCRIPTION	PAGE
01661	20" dx54" w Silhouette, Two-Student	158
01663	20" dx54" w Silhouette, Two-Student, fixed-height, w/glides	158
01665	20" dx54" w Silhouette, Two-Student, fixed-height, w/casters	158
01655	Silhouette Sequence, Single-Student	162
01658	Silhouette Sequence, Single-Student, fixed-height, w/glides	162
01659	Silhouette Sequence, Single-Student, fixed-height, w/casters	162
01653	Silhouette Curve, Single-Student	163
01654	Silhouette Curve, Single-Student, fixed-height, w/glides	163
01657	Silhouette Curve, Single-Student, fixed-height, w/casters	163
01670	24" dx27" w Silhouette, Single-Student, Adjustable 22"-34" h	159
01671	24" dx30" w Silhouette, Single-Student, Adjustable 22"-34" h	159
01675	24" dx48" w Silhouette, Two-Student, Adjustable 22"-34" h	159
01676	24" dx54" w Silhouette, Two-Student, Adjustable 22"-34" h	159
01677	24" dx60" w Silhouette, Two-Student, Adjustable 22"-34" h	159
Interchange™ Open Front Student Desks		
04500	Single-Student Open Front Rectangle	103
04502	Two-Student Open Front Rectangle	103
04503	Wing Open Front	94
04504	Diamond Open Front	98
04505	Mini Diamond Open Front	98
67638	Open Front Backpack Hook	94, 98
Interchange Student Desks		
03002	Interchange 3-2-1 Desk	104
03011	Interchange 3-2-1-LS Desk	104
03081	Interchange Two-Student Diamond Desk	100
03082	Interchange Diamond Student Desk	97
03083	Interchange Mini Diamond Desk	97
03095	Interchange Wing Desk	92
03097	Interchange Swoop Wing Desk	93
04089	Interchange Sequence Desk	103
04090	Interchange Curve Desk	103
67639	Interchange Backpack Hook	103
Interchange Rectangle Activity Tables		
04080	20" dx27" w Rectangle Interchange Activity Table	103
04081	20" dx30" w Rectangle Interchange Activity Table	112
04082	20" dx36" w Rectangle Interchange Activity Table	112
04083	20" dx48" w Rectangle Interchange Activity Table	112
04084	20" dx54" w Rectangle Interchange Activity Table	112
04085	20" dx60" w Rectangle Interchange Activity Table	112
04086	20" dx72" w Rectangle Interchange Activity Table	112
04087	20" dx90" w Rectangle Interchange Activity Table	112
04100	24" dx36" w Rectangle Interchange Activity Table	112
04101	24" dx48" w Rectangle Interchange Activity Table	112
04131	24" dx54" w Rectangle Interchange Activity Table	112
04102	24" dx60" w Rectangle Interchange Activity Table	112
04103	24" dx72" w Rectangle Interchange Activity Table	112
04104	24" dx90" w Rectangle Interchange Activity Table	112
04105	30" dx36" w Rectangle Interchange Activity Table	112
04106	30" dx48" w Rectangle Interchange Activity Table	112
04107	30" dx60" w Rectangle Interchange Activity Table	112
04108	30" dx72" w Rectangle Interchange Activity Table	112
04109	30" dx90" w Rectangle Interchange Activity Table	112
04111	36" dx48" e Rectangle Interchange Activity Table	112
04112	36" dx60" w Rectangle Interchange Activity Table	112
04113	36" dx72" w Rectangle Interchange Activity Table	112
04114	36" dx90" w Rectangle Interchange Activity Table	112
04116	42" dx60" w Rectangle Interchange Activity Table	112
04117	42" dx72" w Rectangle Interchange Activity Table	112
04118	42" dx90" w Rectangle Interchange Activity Table	112
04121	48" dx60" w Rectangle Interchange Activity Table	112

MODEL	DESCRIPTION	PAGE
04122	48" dx72" w Rectangle Interchange Activity Table	112
04123	48" dx90" w Rectangle Interchange Activity Table	112
Interchange Square Activity Tables		
04110	36" dx36" w Square Interchange Activity Table	114
04115	42" dx42" w Square Interchange Activity Table	114
04119	48" dx48" w Square Interchange Activity Table	114
Interchange Round Activity Tables		
04124	42" dia. Round Interchange Activity Table	114
04125	48" dia. Round Interchange Activity Table	114
04126	60" dia. Round Interchange Activity Table	114
Interchange Activity Tables		
04127	30" dx60" w Trapezoid Interchange Activity Table	114
04128	36" dx72" w Half Moon Interchange Activity Table	114
04129	36" dx72" w Contour Interchange Activity Table	114
04130	48" dx72" w Kidney Interchange Activity Table	114
04132	60" dia. Flower Interchange Activity Table	114
04151	30" dx60" w Interchange Butcher Block Table	113
04152	48" dia. Cookie Interchange Activity Table	107
04154	60" w Squiggle Interchange Activity Table	106
04155	72" w Squiggle Interchange Activity Table	106
04156	72" w Crescent Interchange Activity Table	108
04157	60" w Crescent Interchange Activity Table	108
04158	36" dx72" w Racetrack Interchange Activity Table	114
04159	36" dx72" w Peanut Interchange Activity Table	114
Interchange Science Tables		
04101T	24" dx48" w Trespa TopLab Plus Interchange Science Table	113
04102T	24" dx60" w Trespa TopLab Plus Interchange Science Table	113
04103T	24" dx72" w Trespa TopLab Plus Interchange Science Table	113
04106T	30" dx48" w Trespa TopLab Plus Interchange Science Table	113
04107T	30" dx60" w Trespa TopLab Plus Interchange Science Table	113
04108T	30" dx72" w Trespa TopLab Plus Interchange Science Table	113
04131T	24" dx54" w Trespa TopLab Plus Interchange Science Table	113
04101_CHM	24" dx48" w Interchange Activity Table w/Chemsurf Top	NIC
04102_CHM	24" dx60" w Interchange Activity Table w/Chemsurf Top	NIC
04103_CHM	24" dx72" w Interchange Activity Table w/Chemsurf Top	NIC
04106_CHM	30" dx48" w Interchange Activity Table w/Chemsurf Top	NIC
04107_CHM	30" dx60" w Interchange Activity Table w/Chemsurf Top	NIC
04108_CHM	30" dx72" w Interchange Activity Table w/Chemsurf Top	NIC
04131_CHM	24" dx54" w Interchange Activity Table w/Chemsurf Top	NIC
Interchange Multimedia Tables		
04133	Engage Multimedia Table	116
04163	Engage Multimedia Table w/4 Power, 8 USB	116
04164	Engage Multimedia Table w/8 Power	116
04165	Engage Multimedia Table w/6 Power, 4 USB	116
04137	Large Round End Multimedia Table	119
04138	Large Round End Multimedia Table w/4 Power, 8 USB	119
04139	Large Round End Multimedia Table w/8 Power	119
04140	Large Round End Multimedia Table w/6 Power, 4 USB	119
04146	Rectangle Multimedia Table	117
04147	Rectangle Multimedia Table, 4 Power & 8 USB	117
04148	Rectangle Multimedia Table, 8 Power	117
04149	Rectangle Multimedia Table, 6 Power & 4 USB	117
04160	Medium Round End Multimedia Table	118
04161	Medium Round End Multimedia Table, 2 Power, 4 USB	118
04162	Medium Round End Multimedia Table, 4 Power	118
04235	Half Boat Multimedia Table	117
04236	Half Boat Multimedia Table, 4 Power & 8 USB	117
04237	Half Boat Multimedia Table, 8 Power	117
04238	Half Boat Multimedia Table, 6 Power & 4 USB	117

MODEL	DESCRIPTION	PAGE
Interchange Leg Inserts		
77159	Interchange Low Range Inserts	121
77158	Interchange High Range Inserts	121
Planner® Access Station 24" deep		
11140	24" dx30"w Access Station, Single-Student	198
11141	24" dx36"w Access Station, Single-Student	198
11142	24" dx42"w Access Station, Single-Student	198
11143	24" dx48"w Access Station, Two-Student	198
11144	24" dx60"w Access Station, Two-Student	198
11145	24" dx72"w Access Station, Two-Student	198
11146	24" dx84"w Access Station, Three-Student	198
11147	24" dx48"w Access Station, 5-Sided Corner	198
Planner Access Stations 30" deep		
11160	30" dx30"w Access Station, Single-Student	198
11161	30" dx36"w Access Station, Single-Student	198
11162	30" dx42"w Access Station, Single-Student	198
11163	30" dx48"w Access Station, Two-Student	198
11164	30" dx60"w Access Station, Two-Student	198
11165	30" dx72"w Access Station, Two-Student	198
11166	30" dx84"w Access Station, Three-Student	198
11167	30" dx48"w Access Station, 5-Sided Corner	198
Planner Science Tables		
11260	24" dx 48" w Science Table w/laminate top w/T-edge	195
11261	24" dx48" w Science Table w/Chemsurf top	NIC
11262	24" dx48" w Science Table w/Trespa TopLab	195
11263	24" dx54" w Science Table w/laminate top w/T-edge	195
11264	24" dx54" w Science Table w/Chemsurf top	NIC
11265	24" dx54" w Science Table w/Trespa TopLab	195
11266	24" dx60" w Science Table w laminate top w/T-edge	195
11267	24" dx60" w Science Table w/Chemsurf top	NIC
11268	24" dx60" w Science Table w/Trespa TopLab	195
11269	24" dx72" w Science Table w/laminate top w/T-edge	195
11270	24" dx72" w Science Table w/Chemsurf top	NIC
11271	24" dx72" w Science Table w/Trespa TopLab	195
11278	30" dx48" w Science Table w/Chemsurf top	NIC
11275	30" dx54" w Science Table w/Chemsurf top	NIC
11273	30" dx60" w Science Table w/Chemsurf top	NIC
11274	30" dx72" w Science Table w/Chemsurf top	NIC
11286	30" dx48" w Science Table w/Trespa TopLab	NIC
11287	30" dx54" w Science Table w/Trespa TopLab	NIC
11288	30" dx60" w Science Table w/Trespa TopLab	195
11289	30" dx72" w Science Table w/Trespa TopLab	NIC
25705	42" dx60" w Science Table w/Trespa TopLab	195
25715	42" dx72" w Science Table w/Trespa TopLab	195
25725	48" dx60" w Science Table w/Trespa TopLab	195
25735	48" dx72" w Science Table w/Trespa TopLab	195
26000	48" dia. Planner Breakaway Peninsula Table	NIC
Flavors® Chairs		43-51
11830	Flavors Adjustable Chair - B Shell, w/casters	59
11831	Flavors Adjustable Chair - B Shell, w/glides	59
11840	Flavors Adjustable Chair - A Shell, w/casters	59
11841	Flavors Adjustable Chair - A Shell, w/glides	59
11842	Flavors Adjustable Stool - A Shell, w/casters	59
11843	Flavors Adjustable Stool - A Shell, w/glides	59
11844	8" h Flavors Stack Chair - C shell	55
11845	10" h Flavors Stack Chair - C shell	55
11846	12" h Flavors Stack Chair - C shell	55
11847	14" h Flavors Stack Chair - B Shell	55
11848	16" h Flavors Stack Chair - B Shell	55

MODEL	DESCRIPTION	PAGE
11849	18" h Flavors Stack Chair - A Shell	55
11851	18" h Flavors Noodle Chair - A Shell	61
11852	16" h Flavors Noodle Chair - B Shell	61
11853	14" h Flavors Noodle Chair - B Shell	61
11854	16" h Flavors Mobile Stack Chair - B Shell, on Casters	55
11855	18" h Flavors Mobile Stack Chair - A Shell, on Casters	55
11859	18" h Flavors Cantilever Base Chair - A Shell	56
11860	14" h Flavors Mobile Stack Chair - B Shell, on Casters	55
11889	24" h Flavors Fixed Height Stool - A Shell	58
11890	28" h Flavors Fixed Height Stool - A Shell	58
17531	Felt glide option for Flavors stacking chairs	55
17558	Steel glide option for stacking chairs, Set of 4 installed	55
17559	Felt glide option for stacking chairs, Set of 4 installed	55
Accessories for Workstations		
17015	Bookbox for Huddle-6 Desk #01265	184
17016	Bookbox for Huddle-8 Desk & Arc-8 Desk #01620-01622	160, 184
17018	Technology Wire Basket	165, 189
17190	Steel Bookbox	165, 189
17200	Wire Book Basket	165, 189
Modesty Panels – Interchange™ Planner Activity Tables		
17201	Modesty Panel for 36" wide table	121, 200
17202	Modesty Panel for 48" wide table	121, 200
17203	Modesty Panel for 60" wide table	121, 200
17204	Modesty Panel for 72" wide table	121, 200
17205	Modesty Panel for 90" wide table	121, 200
Accessories		
17213	CPU Holder w/locks	167, 201
17217	CPU Holder w/locks	167, 201
17342	23" Center Pull-Out Knee Drawer	203
17351	Flat Panel Mount w/Tilt & Swivel	167, 201
17352	Flat Panel Mount w/Swing-Out Arm w/Tilt & Swivel	203
17353	Clamp-on Flat Panel Mount w/Swing-Out Arm w/Tilt & Swivel	203
17354	Large Monitor Table Mount (32" to 50")	216
17620	Pull-out Keyboard, adjustable height	181
17622	Pull-out Keyboard, adjustable height	181
17655	Spring Loaded Flat Panel Mount with tilt, swivel	185
Casters for Interchange, Flex, Planner, Acrobat® Silhouette, Elemental® Activity		
17554	4" Dual wheel Pack, Set of 4, 2 locking	181, 151
17574	4" Dual wheel Pack, Set of 5, 2 locking (Acrobat Crescent)	212
17576	3" Dual wheel Pack, Set of 4, 4 locking	105, 125, 143, 169, 181
17577 _ _ _	3" Dual wheel Pack, Set of 4, 4 locking (COLOR)	105, 125, 169, 181
17578 _ _ _	3" Dual wheel Pack, Set of 5, 5 locking (COLOR)	92, 125
17578 BLA	3" Dual wheel Pack, Set of 5, 5 locking	92, 125
17599 _ _ _	3" Dual wheel Pack, Set of 6, 6 locking (COLOR)	125
Drawer Pedestals		
19172	Mobile Drawer Pedestal, File/File	203
19173	Mobile Drawer Pedestal, Box/Box/File	203
Booktrucks		
21001	6 Sloping Shelf w/4" casters	268
21004	6 Sloping Shelf w/6 book supports w/4" casters	268
21051	3 Flat shelf w/4" casters	268
21088	Everything Cart, 2 Shelf w/6 bins	267
21090	Utility Cart, 2 deep Shelves	267
21092	3 Sloping Shelf Truck w/4" casters	268
21094	3 Sloping Shelf Truck w/3 book supports & 4" casters	268
21096	3 Sloping Shelf Truck w/4" casters	268
21101	Gorilla Truck™ 6 Sloping Shelf w/six 4" casters	268
21104	3 pack of sliding dividers for 21001-21031	269

Index

MODEL	DESCRIPTION	PAGE
21105	3 pack of sliding dividers for 21092-21096	269
21109	Book Truck Top, fits 36" wide trucks, platinum bracket	269
21900	Cascade Nomad Cart	266
17560	Booktruck 4" Caster pack, set of 4	269
17565	Booktruck 4" Caster pack, 2 locking, set of 4	269
17566	Booktruck 5" Caster pack, set of 4	269
17567	Booktruck 5" Caster pack, 2 locking, set of 4	269
17568	Booktruck 5" Caster pack, single wheel, set of 4	269
17569	Booktruck 5" Caster pack, single wheel, 2 locking, set of 4	269
Planner® Lab Station		
24610	24" dx36" w Planner Lab Station	196
24500	24" dx48" w Planner Lab Station	196
24510	24" dx60" w Planner Lab Station	196
24520	24" dx72" w Planner Lab Station	196
24620	24" dx84" w Planner Lab Station	196
24530	30" dx30" w Planner Lab Station	196
24630	30" dx36" w Planner Lab Station	196
24540	30" dx48" w Planner Lab Station	196
24550	30" dx60" w Planner Lab Station	196
24560	30" dx72" w Planner Lab Station	196
24570	30" dx84" w Planner Lab Station	196
Planner Corner Lab Station		
24600	30" dx48" w Corner Planner Lab Station, 6-Sided corner	197
24580	35" dx80" w Cluster Work Center, Trap	197
Planner Studio Tables		156-161
25254F	30" dx48" w Planner Studio Table, Adjustable Height (casters)	180
25255F	30" dx48" w Planner Studio Table, Adjustable Height (glides)	180
25256F	30" dx60" w Planner Studio Table, Adjustable Height (casters)	180
25257F	30" dx60" w Planner Studio Table, Adjustable Height (glides)	180
25258F	30" dx72" w Planner Studio Table, Adjustable Height (casters)	180
25259F	30" dx72" w Planner Studio Table, Adjustable Height (glides)	180
25200F	36" dx48" w Planner Studio Table, Fixed-Height 29"H (casters)	174
25201F	36" dx48" w Planner Studio Table, Fixed-Height 29"H (glides)	174
25202F	36" dx48" w Planner Studio Table, Fixed-Height 36"H (casters)	174
25203F	36" dx48" w Planner Studio Table, Fixed-Height 36"H (glides)	174
25204F	36" dx48" w Planner Studio Table, Fixed-Height 40"H (casters)	174
25205F	36" dx48" w Planner Studio Table, Fixed-Height 40"H (glides)	174
25206F	36" dx60" w Planner Studio Table, Fixed-Height 29"H (casters)	174
25207F	36" dx60" w Planner Studio Table, Fixed-Height 29"H (glides)	174
25208F	36" dx60" w Planner Studio Table, Fixed-Height 36"H (casters)	174
25209F	36" dx60" w Planner Studio Table, Fixed-Height 36"H (glides)	174
25210F	36" dx60" w Planner Studio Table, Fixed-Height 40"H (casters)	174
25211F	36" dx60" w Planner Studio Table, Fixed-Height 40"H (glides)	174
25212F	36" dx72" w Planner Studio Table, Fixed-Height 29"H (casters)	174
25213F	36" dx72" w Planner Studio Table, Fixed-Height 29"H (glides)	174
25214F	36" dx72" w Planner Studio Table, Fixed-Height 36"H (casters)	174
25215F	36" dx72" w Planner Studio Table, Fixed-Height 36"H (glides)	174
25216F	36" dx72" w Planner Studio Table, Fixed-Height 40"H (casters)	174
25217F	36" dx72" w Planner Studio Table, Fixed-Height 40"H (glides)	174
25218F	42" dx48" w Planner Studio Table, Fixed-Height 29"H (casters)	174
25219F	42" dx48" w Planner Studio Table, Fixed-Height 29"H (glides)	174
25220F	42" dx48" w Planner Studio Table, Fixed-Height 36"H (casters)	174
25221F	42" dx48" w Planner Studio Table, Fixed-Height 36"H (glides)	174
25222F	42" dx48" w Planner Studio Table, Fixed-Height 40"H (casters)	174
25223F	42" dx48" w Planner Studio Table, Fixed-Height 40"H (glides)	174
25224F	42" dx60" w Planner Studio Table, Fixed-Height 29"H (casters)	174
25225F	42" dx60" w Planner Studio Table, Fixed-Height 29"H (glides)	174
25226F	42" dx60" w Planner Studio Table, Fixed-Height 36"H (casters)	174
25227F	42" dx60" w Planner Studio Table, Fixed-Height 36"H (glides)	174

MODEL	DESCRIPTION	PAGE
25228F	42" dx60" w Planner Studio Table, Fixed-Height 40" h (casters)	174
25229F	42" dx60" w Planner Studio Table, Fixed-Height 40" h (glides)	174
25230F	42" dx72" w Planner Studio Table, Fixed-Height 29" h (casters)	174
25231F	42" dx72" w Planner Studio Table, Fixed-Height 29" h (glides)	174
25232F	42" dx72" w Planner Studio Table, Fixed-Height 36" h (casters)	174
25233F	42" dx72" w Planner Studio Table, Fixed-Height 36" h (glides)	174
25234F	42" dx72" w Planner Studio Table, Fixed-Height 40" h (casters)	174
25235F	42" dx72" w Planner Studio Table, Fixed-Height 40" h (glides)	174
25236F	48" dx48" w Planner Studio Table, Fixed-Height 29" h (casters)	177
25237F	48" dx48" w Planner Studio Table, Fixed-Height 29" h (glides)	177
25238F	48" dx48" w Planner Studio Table, Fixed-Height 36" h (casters)	177
25239F	48" dx48" w Planner Studio Table, Fixed-Height 36" h (glides)	177
25240F	48" dx48" w Planner Studio Table, Fixed-Height 40" h (casters)	177
25241F	48" dx48" w Planner Studio Table, Fixed-Height 40" h (glides)	177
25242F	48" dx60" w Planner Studio Table, Fixed-Height 29" h (casters)	177
25243F	48" dx60" w Planner Studio Table, Fixed-Height 29" h (glides)	177
25244F	48" dx60" w Planner Studio Table, Fixed-Height 36" h (casters)	177
25245F	48" dx60" w Planner Studio Table, Fixed-Height 36" h (glides)	177
25246F	48" dx60" w Planner Studio Table, Fixed-Height 40" h (casters)	177
25247F	48" dx60" w Planner Studio Table, Fixed-Height 40" h (glides)	177
25248F	48" dx72" w Planner Studio Table, Fixed-Height 29" h (casters)	177
25249F	48" dx72" w Planner Studio Table, Fixed-Height 29" h (glides)	177
25250F	48" dx72" w Planner Studio Table, Fixed-Height 36" h (casters)	177
25251F	48" dx72" w Planner Studio Table, Fixed-Height 36" h (glides)	177
25252F	48" dx72" w Planner Studio Table, Fixed-Height 40" h (casters)	177
25253F	48" dx72" w Planner Studio Table, Fixed-Height 40" h (glides)	177
25260	Planner Studio Mobile Whiteboard	183
25270	Studio Single Bench	182
25271	Studio Single Bench	182
25272	Studio Double Bench	182
25273	Studio Double Bench	182
Planner Studio Accessories		
77244	(x2) 48" w Planner Studio Foot Rest	175, 176
77245	(x2) 60" w Planner Studio Foot Rest	175, 176
77246	(x2) 72" w Planner Studio Foot Rest	175, 176
70004	30" x48" Planner Studio Foot Rest	180
70005	30" x60" Planner Studio Foot Rest	180
70006	30" x72" Planner Studio Foot Rest	180
77250	Second Surface Kit for 48" w - 36" d / 42" d Studio Tables	174
77251	Second Surface Kit for 60" w - 36" d / 42" d Studio Tables	174
77252	Second Surface Kit for 72" w - 36" d / 42" d Studio Tables	174
77253	Second Surface Kit for 48" w - 48" d Studio Tables	176
77254	Second Surface Kit for 60" w - 48" d Studio Tables	176
77255	Second Surface Kit for 72" w - 48" d Studio Tables	176
77248	Planner Studio Power Module	174, 176
77249	Planner Studio Backpack Hook	176
Planner Activity Tables – Rectangle		
25950	20" dx36" w Rectangle Planner Activity Table	191
25960	20" dx48" w Rectangle Planner Activity Table	191
25970	20" dx60" w Rectangle Planner Activity Table	191
25980	20" dx72" w Rectangle Planner Activity Table	191
25990	20" dx90" w Rectangle Planner Activity Table	191
25800	24" dx36" w Rectangle Planner Activity Table	191
25810	24" dx48" w Rectangle Planner Activity Table	191
25820	24" dx60" w Rectangle Planner Activity Table	191
25830	24" dx72" w Rectangle Planner Activity Table	191
25840	24" dx90" w Rectangle Planner Activity Table	191
25500	30" dx36" w Rectangle Planner Activity Table	191
25510	30" dx48" w Rectangle Planner Activity Table	191

MODEL	DESCRIPTION	PAGE
25520	30" dx60" w Rectangle Planner Activity Table	191
25521	30" dx60" w Planner Activity Butcher Block Table	194
25530	30" dx72" w Rectangle Planner Activity Table	191
25540	30" dx90" w Rectangle Planner Activity Table	191
25550	36" dx48" w Rectangle Planner Activity Table	191
25560	36" dx60" w Rectangle Planner Activity Table	191
25570	36" dx72" w Rectangle Planner Activity Table	191
25580	36" dx90" w Rectangle Planner Activity Table	191
25700	42" dx60" w Rectangle Planner Activity Table	191
25710	42" dx72" w Rectangle Planner Activity Table	191
25590	42" dx90" w Rectangle Planner Activity Table	191
25720	48" dx60" w Rectangle Planner Activity Table	191
25730	48" dx72" w Rectangle Planner Activity Table	191
25740	48" dx90" w Rectangle Planner Activity Table	191
17500	Planner Activity Table High Leg Inserts (4 pack)	200
Planner Activity Tables		
25600	30" dx60" w Trapezoid Planner Activity Table	193
25610	48" dx48" w Square Planner Activity Table	193
25620	42" dia. Round Planner Activity Table	193
25630	48" dia. Round Planner Activity Table	193
25640	60" dia. Round Planner Activity Table	193
25645	60" dia. Flower Planner Activity Table	193
25650	36" dx72" w Half Moon Planner Activity Table	193
25660	36" dx72" w Contour Planner Activity Table	193
25665	48" dx72" w Kidney Planner Activity Table	193
Single Pedestal Cascade® Teacher Desk		
26140	SP Cascade Teacher Desk, BBF Right Hand, P-TOP LEFT	259
26141	SP Cascade Teacher Desk, BBF Left Hand, P-TOP RIGHT	259
26150	SP Cascade Teacher Desk w/six 3" totes (LH)	259
26151	SP Cascade Teacher Desk w/six 3" totes (RH)	259
26152	SP Cascade Teacher Desk w/six 3" totes (LH) w/door	259
26153	SP Cascade Teacher Desk w/six 3" totes (RH) w/door	259
26154	SP Cascade Teacher Desk w/two 3" & 1x12" tote (LH)	259
26155	SP Cascade Teacher Desk w/two 3" & 1x12" tote (RH)	259
26156	SP Cascade Teacher Desk w/two 3" & 1x12" tote w/door	259
26157	SP Cascade Teacher Desk w/two 3" & 1x12" tote w/door	259
26158	SP Cascade Teacher Desk BBF Ped (LH)	259
26159	SP Cascade Teacher Desk BBF Ped (RH)	259
Single Bullet Cascade Teacher Desk		
26160	SB Teacher Desk BBF (LH)	262
26161	SB Teacher Desk BBF (RH)	262
26162	SB Teacher Desk w/two 3" totes & one 12" tote (LH)	263
26163	SB Teacher Desk w/two 3" totes & one 12" tote (RH)	263
26164	SB Teacher Desk w/two 3" totes & one 12" tote (LH) w/Door	263
26165	SB Teacher Desk w/two 3" totes & one 12" tote (RH) w/Door	263
26166	SB Cascade Teacher Desk w/six 3" totes (LH)	263
26167	SB Cascade Teacher Desk w/six totes (RH)	263
26168	SB Cascade Teacher Desk w/six totes (LH) w/Door	263
26169	SB Cascade Teacher Desk w/six totes (RH) w/Door	263
Double Pedestal Cascade Teacher Desk		
26170	DP Teacher Desk w/twelve 3" totes	261
26171	DP Teacher Desk w/four 3" & two 12" tote	261
26172	DP Teacher Desk w/six 3" totes & BBF Ped	261
26173	DP Teacher Desk w/two 3" & one 12" tote & BBF Ped	261
26174	DP Teacher Desk w/twelve 3" totes w/door	261
26175	DP Teacher Desk w/four 3" & two 12" totes w/door	261
26176	DP Teacher Desk w/six 3" totes & BBF Ped w/door	261
26177	DP Teacher Desk w/two 3" & one 12" tote & BBF Ped w/door	261
26178	DP Cascade Teacher Desk w/two BBF Peds	261
26188	DP Cascade Teacher Desk w/FF & BBF	261

MODEL	DESCRIPTION	PAGE
Double Bullet Cascade Teacher Desk		
26179	DP Cascade Teacher Desk w/two 3" & one 12" & BBF	264
26180	DP Cascade Teacher Desk w/two BBF	264
26181	DP Teacher Desk w/two 3" totes, one 12" tote w/door & BBF	264
26182	DP Cascade Teacher Desk w/twelve 3"	264
26183	DP Cascade Teacher Desk w/twelve 3" w/door	264
26184	DP Cascade Teacher Desk w/four 3" & two 12"	264
26185	DP Cascade Teacher Desk w/four 3" and two 12" w/door	264
26186	DP Cascade Teacher Desk w/six 3" & BBF	264
26187	DP Cascade Teacher Desk w/six 3" & BBF w/door	264
26194	DP Cascade Teacher Desk w/one FF & one BBF	264
Cascade Teacher Desk Accessories		
19195	Cascade Drawer Ped w/top & six 3" totes	259, 264
19196	Cascade Drawer Ped w/top & two 3" & one 12" tote	259, 264
19197	Cascade Drawer Ped w/door & top six 3" totes	259, 264
19198	Cascade Drawer Ped w/door & top & two 3", one 12" tote	259, 264
19199	Cascade Box/Box/File Pedestal	259, 264
19201	Cascade File/File Pedestal	259, 264
SIT + STAND		
Sit + Stand Lecterns		
26552V	Sit + Stand Lectern, 20"x23.5" Rectangle (30"-45"h)	147
26553V	Sit + Stand Lectern, 21"x30" Oblong Top (30"-45"h)	147
Sit + Stand Student Desks		
26547V	Sit + Stand Desk, 20"x23.5" Rectangle (26"-41.5"h)	146
26548V	Sit + Stand Desk, 21"x30" Collaborative (26"-41.5"h)	146
26549V	Sit + Stand Desk, 20"x27" Rectangle (26"-41.5"h)	146
Sit + Stand Student Desk Accessories		
76517	Sit + Stand Privacy Screen / Modesty Panel	146
76518	Sit + Stand Technology Basket	146
Groove™ Seating		
33847	14" Groove Stack Chair - B Shell	40
33848	16" Groove Stack Chair - B Shell	40
33849	18" Groove Stack Chair - A Shell	40
33854	16" Groove Mobile Stack Chair - B Shell, on casters	40
33855	18" Groove Mobile Stack Chair - A Shell, on casters	40
33889	24" Groove Fixed-Height Stool - A Shell	42
33891	30" Groove Fixed-Height Stool - A Shell	42
33840	Groove Adjustable Chair - A Shell w/casters	43
33841	Groove Adjustable Chair - A Shell w/glides	43
33842	Groove Adjustable Stool - A Shell w/casters	43
33843	Groove Adjustable Stool - A Shell w/glides	43
33879	18" Groove Cantilever Chair - A Shell	40
Theorem™ Seating		
44849	18" Theorem Stack Chair - A Shell	48
44819	18" Theorem Stack Chair - A Shell w/arms	49
44855	18" Theorem Mobile Stack Chair - A Shell, on casters	48
44815	18" Theorem Mobile Stack Chair - A Shell, on casters w/arms	49
44840	Theorem Adjustable Chair - A Shell w/casters	51
44841	Theorem Adjustable Chair - A Shell w/glides	51
44842	Theorem Adjustable Stool - A Shell w/casters	51
44843	Theorem Adjustable Stool - A Shell w/glides	51
44879	18" Theorem Cantilever Chair - A Shell	50
44820	18" Theorem Rod Frame Chair	47
44891	30" Theorem Rod Frame Stool, Fixed-Height	47
Soft Rocker & Ottoman 106-125		
55000	Soft Rocker	80
55001	26" Ottoman	81
Elemental® Activity Tables 106-125		
ELSPRK	59.25" dx67" w Elemental Sprocket, 6 Legs	127
ELSS48	48" dia. Elemental 5-Star, 5 Legs, (K-5)	127

Index

MODEL	DESCRIPTION	PAGE
EL5S60	60" dia. Elemental 5-Star, 5 Legs	127
EL6S60	60" dia. Elemental 6-Star, 6 Legs	127
ELENT	30" dx60" w Elemental Engage Trapezoid, 4 Legs	127
ELYNYG	64" dx54" w Elemental Yin Yang, 4 Legs	128
ELMOON	60" dx41" w Elemental Moon, 4 Legs	128
EL36ER	30" dx60" w Elemental Engage Rectangle, 4 Legs	129
EL37ER	30" dx72" w Elemental Engage Rectangle, 4 Legs	129
EL42ES	42" dx42" w Elemental Engage Square, 4 Legs	129
EL48ES	48" dx48" w Elemental Engage Square, 4 Legs	129
EL60CR	30" dx60" w Elemental Crescent, 5 Legs (seats 3)	130
EL72CR	36" dx72" w Elemental Crescent, 5 Legs (seats 4)	130
EL60SG	60" Elemental Squiggle Table, 4 Legs	131
EL72SG	72" Elemental Squiggle Table, 4 Legs	131
EL2436	24" dx36" w Elemental Rectangle, 4 Legs	132
EL2448	24" dx48" w Elemental Rectangle, 4 Legs	132
EL2460	24" dx60" w Elemental Rectangle, 4 Legs	132
EL2472	24" dx72" w Elemental Rectangle, 4 Legs	132
EL3048	30" dx48" w Elemental Rectangle, 4 Legs	132
EL3060	30" dx60" w Elemental Rectangle, 4 Legs	132
EL3072	30" dx72" w Elemental Rectangle, 4 Legs	132
EL3636	36" dx36" w Elemental Square, 4 Legs	133
EL4242	42" dx42" w Elemental Square, 4 Legs	133
EL4848	48" dx48" w Elemental Square, 4 Legs	133
EL60TR	30" dx60" w Elemental Trapezoid, 4 Legs	133
EL4872	48" dx72" w Elemental Kidney Table, 4 Legs	135
EL42RD	42" dia. Elemental Round, 4 Legs	135
EL48RD	48" dia. Elemental Round, 4 Legs	135
ELHAMO	36" dx72" w Elemental Half Moon, 4 Legs	134
EL48CL	48" dia. Elemental Clover, 4 Legs	134
Elemental Caster Options		
4 Quantity Caster Packs, for 4 Leg Tables		
17576	3" Dual-Wheel Casters, set of 4, locking (BLACK)	141
17577 PLT	3" Dual-Wheel Casters, set of 4, locking (PLATINUM)	141
17577 CGR	3" Dual-Wheel Casters, set of 4, locking (CHARCOAL)	141
17577 ORG	3" Dual-Wheel Casters, set of 4, locking (ORANGE)	141
17577 CER	3" Dual-Wheel Casters, set of 4, locking (CERULEAN)	141
17577 APL	3" Dual-Wheel Casters, set of 4, locking (APPLE)	141
5 Quantity Caster Packs, for 5 Leg Tables		
17578 BLA	3" Dual-Wheel Casters, set of 5, locking (BLACK)	108, 141
17578 PLT	3" Dual-Wheel Casters, set of 5, locking (PLATINUM)	141
17578 CGR	3" Dual-Wheel Casters, set of 5, locking (CHARCOAL)	141
17578 ORG	3" Dual-Wheel Casters, set of 5, locking (ORANGE)	141
17578 CER	3" Dual-Wheel Casters, set of 5, locking (CERULEAN)	141
17578 APL	3" Dual-Wheel Casters, set of 5, locking (APPLE)	141
6 Quantity Caster Packs, for 6 Leg Tables		
17599 BLA	3" Dual-Wheel Casters, set of 6, locking (BLACK)	141
17599 PLT	3" Dual-Wheel Casters, set of 6, locking (PLATINUM)	141
17599 CGR	3" Dual-Wheel Casters, set of 6, locking (CHARCOAL)	141
17599 ORG	3" Dual-Wheel Casters, set of 6, locking (ORANGE)	141
17599 CER	3" Dual-Wheel Casters, set of 6, locking (CERULEAN)	141
17599 APL	3" Dual-Wheel Casters, set of 6, locking (APPLE)	141
Elemental Nest & Fold Tables 120-123		
NL2448__EF	24" dx48" w Elemental Nest & Fold Table (FIXED-HEIGHT)	138
NL2460__EF	24" dx60" w Elemental Nest & Fold Table (FIXED-HEIGHT)	138
NL2472__EF	24" dx72" w Elemental Nest & Fold Table (FIXED-HEIGHT)	138
NL3048__EF	30" dx48" w Elemental Nest & Fold Table (FIXED-HEIGHT)	138
NL3060__EF	30" dx60" w Elemental Nest & Fold Table (FIXED-HEIGHT)	138
NL3072__EF	30" dx72" w Elemental Nest & Fold Table (FIXED-HEIGHT)	138
NL2448__EJ	24" dx48" w Elemental Nest & Fold Table (ADJ. HEIGHT)	138
NL2460__EJ	24" dx60" w Elemental Nest & Fold Table (ADJ. HEIGHT)	138

MODEL	DESCRIPTION	PAGE
NL2472__EJ	24" dx72" w Elemental Nest & Fold Table (ADJ. HEIGHT)	138
NL3048__EJ	30" dx48" w Elemental Nest & Fold Table (ADJ. HEIGHT)	138
NL3060__EJ	30" dx60" w Elemental Nest & Fold Table (ADJ. HEIGHT)	138
NL3072__EJ	30" dx72" w Elemental Nest & Fold Table (ADJ. HEIGHT)	138
UXL® Nest & Fold Tables		150-153
FL2448	24" dx48" w UXL Nest & Fold Table	150
FL2460	24" dx60" w UXL Nest & Fold Table	150
FL2472	24" dx72" w UXL Nest & Fold Table	150
FL3048	30" dx48" w UXL Nest & Fold Table	150
FL3060	30" dx60" w UXL Nest & Fold Table	150
FL3072	30" dx72" w UXL Nest & Fold Table	150
FL48HR	48" UXL Nest & Fold Table, Half Round Table	150
FL60HR	60" UXL Nest & Fold Table, Half Round Table	150
AL2448	24" dx48" w UXL Adj. Nest & Fold Table	153
AL2460	24" dx60" w UXL Adj. Nest & Fold Table	153
AL2472	24" dx72" w UXL Adj. Nest & Fold Table	153
AL3048	30" dx48" w UXL Adj. Nest & Fold Table	153
AL3060	30" dx60" w UXL Adj. Nest & Fold Table	153
AL3072	30" dx72" w UXL Adj. Nest & Fold Table	153
AL48HR	26.5" dx48" w UXL Adj. Nest & Fold Table, Half Round Table	153
AL60HR	30.25" dx60" w UXL Adj. Nest & Fold Table, Half Round Table	153
CASCADE® STORAGE		
Cascade Mini-Case w/Casters		
11100000P	Open w/shelves	232
12100000P	Door w/shelves	232
111V0000P	Open w/shelves & riser	232
121V0000P	Door w/shelves & riser	232
111L0000P	Open w/shelves & lectern	232
121L0000P	Door w/shelves & lectern	232
11000500P	Open w/five 3" EW totes	232
12000500P	Door w/five 3" EW totes	232
110V0500P	Open w/five 3" EW totes & riser	232
120V0500P	Door w/five 3" EW totes & riser	232
110L0500P	Open w/five 3" EW totes & lectern	232
120L0500P	Door w/five 3" EW totes & lectern	232
11000301P	Open w/three 3" & one 6" EW tote	232
12000301P	Door w/three 3" & one 6" EW tote	232
110V0301P	Open w/three 3" & one 6" EW tote & riser	232
120V0301P	Door w/three 3" & one 6" EW tote & riser	232
110L0301P	Open w/three 3" & one 6" EW tote & lectern	232
120L0301P	Door w/three 3" & one 6" EW tote & lectern	232
11000500H	Open w/five 3" EW totes + Peg Board End Panels	235
Cascade Mid-Case w/Casters		
21100000P	Open w/shelves	232
22100000P	Doors w/shelves	232
211V0000P	Open w/shelves & riser	232
221V0000P	Doors w/shelves & riser	232
211L0000P	Open w/shelves & lectern	232
221L0000P	Doors w/shelves & lectern	232
21001000P	Open w/ten 3" totes	232
22001000P	Doors w/ten 3" totes	232
210V1000P	Open w/ten 3" totes & riser	232
220V1000P	Doors w/ten 3" totes & riser	232
210L1000P	Open w/ten 3" totes & lectern	232
220L1000P	Doors w/ten 3" totes & lectern	232
21000602P	Open w/six 3" & two 6" totes	232
22000602P	Doors w/six 3" & two 6" totes	232
210V0602P	Open w/six 3" & two 6" totes & riser	232
220V0602P	Doors w/six 3" & two 6" totes & riser	232
210L0602P	Open w/six 3" & two 6" totes & lectern	232

MODEL	DESCRIPTION	PAGE
220L06020P	Doors w/six 3" & two 6" totes & lectern	232
211T00000P	Spiral Noteboard Open w/shelves	245
221T00000P	Spiral Noteboard Doors w/shelves	245
210T10000P	Spiral Noteboard Open w/ten 3" SW totes	245
220T10000P	Spiral Noteboard Doors w/ten 3" SW totes	245
210T06020P	Spiral Noteboard Open w/six 3" & two 6" SW totes	245
220T06020P	Spiral Noteboard Doors w/six 3" & two 6" SW totes	245
210010000H	Open w/ten 3" SW totes + Peg Board End Panels	247

Cascade Mega-Case w/Casters

311000000P	Open w/shelves	233
321000000P	Doors w/shelves	233
311100000P	Open w/shelves & riser	233
321100000P	Doors w/shelves & riser	233
311J00000P	Open w/shelves & lectern	233
321J00000P	Doors w/shelves & lectern	233
310015000P	Open w/fifteen 3" totes	233
320015000P	Doors w/fifteen 3" totes	233
310115000P	Open w/fifteen 3" totes & riser	233
320115000P	Doors w/fifteen 3" totes & riser	233
310J15000P	Open w/fifteen 3" totes & lectern	233
320J15000P	Doors w/fifteen 3" totes & lectern	233
310009030P	Open w/nine 3" & three 6" totes	233
320009030P	Doors w/nine 3" & three 6" totes	233
310109030P	Open w/nine 3" & three 6" totes & riser	233
320109030P	Doors w/nine 3" & three 6" totes & riser	233
310J09030P	Open w/nine 3" & three 6" totes & lectern	233
320J09030P	Doors w/nine 3" & three 6" totes & lectern	233
A10006020P	Open w/six 3" & two 6" EW totes	233
A20006020P	Doors w/six 3" & two 6" EW totes	233
A10106020P	Open w/six 3" & two 6" EW totes & riser	233
A20106020P	Doors w/six 3" & two 6" EW totes & riser	233
A10J06020P	Open w/six 3" & two 6" EW totes & lectern	233
A20J06020P	Doors w/six 3" & two 6" EW totes & lectern	233
A10010000P	Open w/ten 3" EW totes	233
A20010000P	Doors w/ten 3" EW totes	233
A10110000P	Open w/ten 3" EW totes & riser	233
A20110000P	Doors w/ten 3" EW totes & riser	233
A10J10000P	Open w/ten 3" EW totes & lectern	233
A20J10000P	Doors w/ten 3" EW totes & lectern	233
310015000H	Open w/fifteen 3" SW totes + Peg Board End Panels	247

Cascade Mini-Cabinet w/Casters

411000000P	Open w/shelves	236
421000000P	Door w/shelves	236
411V00000P	Open w/shelves & riser	236
421V00000P	Door w/shelves & riser	236
411L00000P	Open w/shelves & lectern	236
410008000P	Open w/eight 3" EW totes	236
420008000P	Door w/eight 3" EW totes	236
410V08000P	Open w/eight 3" EW totes & riser	236
420V08000P	Door w/eight 3" EW totes & riser	236
410004020P	Open w/four 3" & two 6" EW tote	236
420004020P	Door w/four 3" & two 6" EW tote	236
410V04020P	Open w/four 3" & two 6" EW tote & riser	236
420V04020P	Door w/four 3" & two 6" EW tote & riser	236
410000040P	Open w/four 6" EW tote	236
420000040P	Door w/four 6" EW tote	236
410V00040P	Open w/four 6" EW tote & riser	236
420V00040P	Door w/four 6" EW tote & riser	236
410008000H	Open w/eight 3" EW totes + Peg Board End Panels	247

MODEL	DESCRIPTION	PAGE
-------	-------------	------

Cascade Mid-Cabinet w/Casters

511000000P	Open w/shelves	236
521000000P	Doors w/shelves	236
511V00000P	Open w/shelves & riser	236
521V00000P	Doors w/shelves & riser	236
511L00000P	Open w/shelves & lectern	236
510016000P	Open w/sixteen 3" totes	236
520016000P	Doors w/sixteen 3" totes	236
510V16000P	Open w/sixteen 3" totes & riser	236
520V16000P	Doors w/sixteen 3" totes & riser	236
510008040P	Open w/eight 3" 4x6" tote	236
520008040P	Doors w/eight 3" 4x6" tote	236
510V08040P	Open w/eight 3" 4x6" tote & riser	236
520V08040P	Doors w/eight 3" 4x6" tote & riser	236
510000080P	Open w/eight 6" totes	236
520000080P	Doors w/eight 6" totes	236
510V00080P	Open w/eight 6" totes & riser	236
520V00080P	Doors w/eight 6" totes & riser	236
510016000H	Open w/sixteen 3" SW totes + Peg Board End Panels	247

Cascade Mega-Cabinet w/Casters

B11000000P	Open w/shelves	237
B11W00000P	Open w/shelves + Whiteboard back	237, 244
B21000000P	Doors w/shelves	237
B21W00000P	Doors w/shelves + Whiteboard back	237, 244
B11100000P	Open w/shelves & riser	237
B21100000P	Doors w/shelves & riser	237
611J00000P	Open w/shelves & lectern	237
610024000P	Open w/twenty-four 3" totes	237
620024000P	Doors w/twenty-four 3" totes	237
610124000P	Open w/twenty-four 3" totes & riser	237
620124000P	Doors w/twenty-four 3" totes & riser	237
610012060P	Open w/twelve 3" & six 6" totes	237
620012060P	Doors w/twelve 3" & six 6" totes	237
610112060P	Open w/twelve 3" & six 6" totes & riser	237
620112060P	Doors w/twelve 3" & six 6" totes & riser	237
B10016000P	Open w/sixteen 3" EW totes	237
B20016000P	Doors w/sixteen 3" EW totes	237
B10116000P	Open w/sixteen 3" EW totes & riser	237
B20116000P	Doors w/sixteen 3" EW totes & riser	237
B10000080P	Open w/eight 6" EW totes	237
B20000080P	Doors w/eight 6" EW totes	237
B10100080P	Open w/eight 6" EW totes & riser	237
B20100080P	Doors w/eight 6" EW totes & riser	237
B10008040P	Open w/eight 3" & four 6" EW totes	237
B20008040P	Doors w/eight 3" & four 6" EW totes	237
B10108040P	Open w/eight 3" & four 6" EW totes & riser	237
B20108040P	Doors w/eight 3" & four 6" EW totes & riser	237
610024000H	Open w/twenty-four 3" SW totes + Peg Board End Panels	247
61200800P	Open w/two shelves & eight 3" SW totes	246
62200800P	Doors w/two shelves & eight 3" SW totes	246

Cascade® Mini-Tower w/Casters

711000000P	Open w/shelves	240
721000000P	Door w/shelves	240
710012000P	Open w/twelve 3" EW totes	240
720012000P	Door w/twelve 3" EW totes	240
710003050P	Open w/three 3" & five 6" EW totes	240
720003050P	Door w/three 3" & five 6" EW totes	240
710000060P	Open w/six 6" EW totes	240
720000060P	Door w/six 6" EW totes	240

Index

MODEL	DESCRIPTION	PAGE
710012000H	Open w/twelve 3" EW totes + Peg Board End Panels	247
Cascade Mid-Tower w/Casters		
811000000P	Open w/shelves	240
821000000P	Doors w/shelves	240
810024000P	Open w/twenty-four 3" totes	240
820024000P	Doors w/twenty-four 3" totes	240
810006062P	Open w/six 3" & six 6" & two 12" totes	240
820006062P	Doors w/six 3" & six 6" & two 12" totes	240
810000120P	Open w/twelve 6" totes	240
820000120P	Doors w/twelve 6" totes	240
810024000H	Open w/twenty-four 3" SW totes + Peg Board End Panels	247
Cascade Mega-Tower w/Casters		
911000000P	Open w/shelves	240
911W00000P	Open w/shelves + Whiteboard Back	240, 242
921000000P	Doors w/shelves	240
921W00000P	Doors w/shelves + Whiteboard Back	240, 242
910036000P	Open w/thirty-six 3" totes	240
920036000P	Doors w/thirty-six 3" totes	240
910009150P	Open w/nine 3" & fifteen 6" totes	240
920009150P	Doors w/nine 3" & fifteen 6" totes	240
910009093P	Open w/nine 3" & nine 6" & three 12" totes	240
920009093P	Doors w/nine 3" & nine 6" & three 12" totes	240
C10024000P	Open w/twenty-four 3" EW totes	240
C20024000P	Doors w/twenty-four 3" EW totes	240
C10014060P	Open w/fourteen 3" & six 6" EW totes	240
C20014060P	Doors w/fourteen 3" & six 6" EW totes	240
910036000H	Open w/thirty-six 3" SW totes + Peg Board End Panels	247
91201200P	Open w/three shelves & twelve 3" SW totes	244
92201200P	Doors w/three shelves & twelve 3" SW totes	244
Cascade Teacher Wardrobe (Mega-Tower) w/Casters		
R10024000P	Open w/twenty-four 3" SW totes	240
R20024000P	Doors w/twenty-four 3" SW totes	240
R10000120P	Open w/twelve 6" SW totes	240
R20000120P	Doors w/twelve 6" SW totes	240
R10006062P	Open w/six 3" & six 6" & two 12" SW totes	240
R20006062P	Doors w/six 3" & six 6" & two 12" SW totes	240
Cascade AV Carts		
W21100000P	Cascade Mid-Case AV Presentation Cart	251
V21100000P	Cascade Mega-Case AV Presentation Cart	251
V21P00000P	Cascade Mega-Case Makercart w/Rod	250
Cascade Cubbies w/Casters		
D11000000P	Mega Case Open w/6 cubbies	248
D21000000P	Mega Case Doors w/6 cubbies	248
E11000000P	Mega Cabinet Open w/9 cubbies	248
E21000000P	Mega Cabinet Doors w/9 cubbies	248
F11000000P	Mega Tower Open w/12 cubbies	248
F21000000P	Mega Tower Doors w/12 cubbies	248
Cascade Cubbies w/Glides		
D31000000P	Mega Case Open w/6 cubbies	248
D41000000P	Mega Case Door w/6 cubbies	248
E31000000P	Mega Cabinet Open w/9 cubbies	248
E41000000P	Mega Cabinet Door w/9 cubbies	248
F31000000P	Mega Tower Open w/12 cubbies	248
F41000000P	Mega Tower Door w/12 cubbies	248
Cascade Two-Sided Whiteboard Units w/casters		
H10030000PP	Two-Sided Whiteboard Unit, w/thirty 3" EW totes	245
H10000140PP	Two-Sided Whiteboard Unit, w/fourteen 6" EW totes	245
Cascade Maker Table		
25300	Cascade Maker Table, 48x48, x30 SW totes	242

MODEL	DESCRIPTION	PAGE
25301	Cascade Maker Table, 48x48, x30 SW totes w/doors	242
25302	Cascade Maker Table, 48x48, shelves	242
25303	Cascade Maker Table, 48x48, shelves w/doors	242
25304	Cascade Maker Table, 48x48, x15 SW totes & shelves	242
25305	Cascade Maker Table, 48x48, x15 SW totes & shelves, w/doors	242
Cascade Nomad Cart		
21900	Cascade Nomad Library Cart	246
Cascade Accessories		
17670 PLT	Optional Laptop Shelf for Cascade	253
Add "W"	Whiteboard Back for Mega-Tower & Mega-Cabinet	242
30925	SW Housing w/tote	144, 164, 169, 253
30926	EW Housing w/tote	144, 169, 253
66013	Interchange SW Tote Tray w/housing	85, 253
66014	Interchange SW Housing only	85, 253
30927	SW housing only	253
30928	EW housing only	253
66002	SW Quad Depth Tote Clear	253
66010	EW Single Depth Tote Clear	253
66011	EW Double Depth Tote Clear	253
66020	SW Tote Lid	253
66021	EW Tote Lid	253
66030	Plastic Label Cover	253
Power Options		
017086 SLV	Flat Surface, 2 Power, 4 USB, silver	184, 104, 252
017093 SLV	Flat Surface, 4 Power, silver	184, 104, 252
017091 SLV	Retractable Surface, 2 Power, silver	184, 104, 252
017085 SLV	Retractable Surface, 2 Power, 4 USB, silver	184, 104, 252
017092 SLV	Retractable Surface, 4 Power, silver	184, 104, 252
017097 SLV	Flat Round, 2 Power	184, 104, 252
017098 SLV	Flat Round, 1 Power, one 2 Port USB	184, 104, 252
017078 BLA	Soft Touch Power Dome, 3 Power	184, 104, 252
017079 BLA	Soft Touch Power Dome, 2 Power, 2 Port USB	184, 104, 252
17081	6 Outlet Electric Strip w/Surge	201
17084	10 Outlet Electric Strip w/Surge	201
17107	4-Plug Power Socket, Clamp On	202

Customer Service, Ordering, Terms and Freight.

PURCHASE ORDERS

Be sure to include: **1.** Quantity **2.** Model Number **3.** Description **4.** Color choice (top, edge, frame color for tables, and shell and frame color for chairs) **5.** Price for each item, including quote number.

Smith System accepts orders via:
- email: smithfax@smithsystem.com
- fax: 972.398.4051

Cancellation or modification of orders must be submitted to Smith System in writing. In some cases a cancellation fee may be charged if raw materials, work in progress or special products are involved. All tops are made to order.

PRICES

All prices shown are ex works; Carrollton (zip code 75006), Texas. Prices are subject to change without notice. Freight charges for shipments are prepaid and added to the invoice.

For delivered pricing or delivered and installed pricing, Smith System produces a price book based on shipping zone.

TERMS

Invoice terms for credit accounts are NET 30 days. Orders are invoiced on day of shipment. New customers and international customers are cash in advance.

Smith System accepts school purchase orders and credit cards. Credit cards are accepted for first order only at standard discount. Smith System accepts Visa, MasterCard or American Express.

QUICK SHIP/SHIPPING LEAD TIMES

All furniture is made to order and part of the Quick Ship program. Quick Ship items are designated in the catalog with Quick Ship. There are 14 Quick Ship laminate colors and 20 bumper edge colors. Frame color

availability is specified on the catalog page. Quick Ship lead time for 20 bumper edge tables and 40 chairs is 5 business days, though this may extend during the busy summer season. Please call for specific availability. If the product components are in stock, they will ship as soon as possible. Non-Quick Ship lead time is 8 to 12 weeks from the time of your order. Call Smith System with questions.

Shipping date is confirmed upon receipt of order. Every attempt will be made to meet that shipping date. However, it is subject to change without prior notification. Smith System reserves the right to discontinue products and change product specifications and prices. We do not pay for split shipments.

DELIVERY

Shipments are sent prepaid with charges added to the invoice. Product shipping weights are for product only. LTL shipments are sent on pallets. Pallet weights will be added to total weight for LTL shipments. Standard LTL shipments do not include inside delivery. Inside delivery is available. Inside delivery requests need to be on the order and appropriate freight charges will be added. Some products can ship UPS. For orders that ship UPS, inside delivery is included in freight charges. Smith System will determine the mode, method and carrier which meet the best delivery criteria.

FREIGHT

Do not refuse freight because of damage or shortage. All merchandise is packed to comply with carrier requirements. For your protection all shipments should be carefully inspected by the consignee before acceptance. The delivering carrier should be requested to record on the delivery receipt any damage to goods or cartons at time of delivery. Also, any shortages should be noted on the delivery receipt. If further damage is found after delivery, immediate inspection by the delivering carrier must be requested. The delivering carrier must be notified at once of concealed damage. All cartons and

merchandise must be held for inspection. Carrier liability ceases after 15 days.

Smith System will assist customers at all times to obtain claim settlement, but the consignee must take the necessary steps to obtain the proof of loss and damages. If customer selects freight carrier, customer is responsible for any freight damage claims. NOTE: Carriers are not responsible for damage or shortage after the delivery receipt is signed without a damage or shortage notification.

Smith System delivers to all 48 continental states. All orders delivering to other states and international locations are ex works Carrollton (zip code 75006), Texas.

CHARGE BACKS

The tare weights and dimensions listed are estimated; therefore Smith System will not be responsible for freight costs associated with these variances. LTL Shipments go on pallets, weights vary.

RETURNS

All tops are made to order and are not returnable. Initiation of a returnable item must begin within 14 days of delivery. Smith System will be unable to accept an item not reported within this time period. No goods will be accepted for return without prior authorization. Agreed returns will be subject to 30% restocking charge, plus any return carrier charges. Any unpacked, used or assembled item will not be considered for return.

WARRANTY

Smith System has a Limited 12 Year Warranty with Lifetime Frame Warranty. For complete details and a copy please contact Customer Service at 1.800.328.1061 or 972.398.4050.

Smith System is 100% UL Greenguard Gold Certified For Children and Schools CertifiedSM on our complete product line.

Smith System®

Smith System®

1150 Luna Road
Carrollton, TX 75006
1.800.328.1061
www.smithsystem.com