



**2020 PRICE INCREASE**

ADD 3% ON ORDERS PLACED  
AFTER JANUARY 31<sup>TH</sup>, 2020

# 2018 PRODUCT GUIDE



**jasper chair**

## TABLE OF CONTENTS

TRUE AMERICAN MANUFACTURING _____	4
VISUAL PRODUCT INDEX _____	6
CHAIRS & STOOLS _____	10
LOUNGE & BENCHES _____	84
TABLES _____	100
PRICING _____	108
MATERIALS _____	176
A BETTER CHAIR _____	192
ORDERING _____	194
TERMS & CARE _____	195
DESIGN CENTER _____	196
INDEX _____	202

# **THE OLD WAY NEVER GETS OLD.**

In 1921, we decided to make chairs in an uncompromising manner. That spirit is alive and well today.

We see every chair from start to finish—beginning with raw lumber, graded, stacked, and dried to absolute perfection. Then, we build, by hand, for restaurants, pubs, schools, libraries, resorts, and senior living communities; the places we work hard, have fun, and call home.

Our history is defined by making chairs people love—and at Jasper Chair, history repeats itself every day.

# AMERICAN. ALWAYS.

Jasper Chair was established in 1921 in the heart of the Midwest in Jasper, Indiana and still maintains the same way of doing business: making quality furniture that can be used for a lifetime. We employ skillfully trained craftsmen and use only the finest raw materials in our manufacturing processes. We operate in a 275,000 square foot facility, under one roof, in our original location.

At the very beginning of a chair, we start with the finest of raw materials. At Jasper Chair, it's important we intimately know where our wood comes from. We purchase over two million board feet each year of the finest northern grown red oak and hard maple lumber harvested right here in the United States. We source from responsible foresters located in our backyard to ensure quality and availability. The lumber is tenaciously graded, sorted and stacked to be properly dried in one of three air-dry facilities on our grounds. This, we believe, is the key to providing furniture that lasts a lifetime. Some lumber may be required to air-dry for as long as a year. Many manufacturers bypass this integral process relying on faster methods or purchasing dried lumber. Here at Jasper Chair, we pledge to not use any inferior components in our furniture, starting with the rawest of our raw materials.

A large portion of our chair designs utilize steam bent solid wood. Steam bending is a lost art in which solid lumber is saturated with steam until the wood fibers are pliable for bending. A labor intensive process many manufacturers

have traded for higher profits, steam bending offers no substitute. It is the only process that truly allows chair components to retain their shape, providing tremendous strength and long lasting performance.

Only after lumber has been deemed of excellent quality through imaging techniques, our craftsmen begin dimensioning, boring, doweling, and sanding the lumber into chair components. Our machine department relies on the finest machinery built from all over the world, ensuring our product is produced quickly and accurately and of the highest possible quality.

Jasper Chair runs constant quality checks. Dimension parts are hand selected for color to ensure continuity. Frame assembly is controlled to secure proper fit and form. All models are built from individually fitted components, we purchase no frames. In finishing, each chair incurs numerous staining and sanding processes for smoothness, followed by multiple layers of catalyzed varnish for a lifetime of beauty. Each chair passes through several temperature controlled ovens to cure the finish for ultimate durability. Finally, the chair is quality inspected one last time to ensure consistency of the order and all quality standards are met.

Then it arrives to you. And as always, the Jasper Chair product will be the silent, but sure, foundation of your business providing a lifetime of performance, comfort and solid beauty.







# INDEX CHAIRS & STOOLS



**ADDI**  
Page 12  
Pricing 110



**AFTON**  
Page 13  
Pricing 111



**ALLIS**  
Page 14  
Pricing 112



**ASHER**  
Page 16  
Pricing 115



**BECKET**  
Page 17  
Pricing 116



**BEXLEY**  
Page 18  
Pricing 118



**BROOKS**  
Page 19  
Pricing 119



**CHELSEY**  
Page 20  
Pricing 120



**CLAY**  
Page 22  
Pricing 121



**CLIVE**  
Page 24  
Pricing 122



**DAKOTA**  
Page 26  
Pricing 124



**DECKER**  
Page 27  
Pricing 125



**DIEGO**  
Page 28  
Pricing 126



**DOLTON**  
Page 30  
Pricing 127



**EDINA**  
Page 32  
Pricing 128



**ELLANOR**  
Page 33  
Pricing 130

# CHAIRS & STOOLS



**HANA**  
Page 35  
Pricing 131



**HAYS**  
Page 36  
Pricing 132



**JOLIET**  
Page 38  
Pricing 134



**KOKO**  
Page 40  
Pricing 135



**LARK**  
Page 41  
Pricing 136



**LORA**  
Page 42  
Pricing 138



**LOUIE**  
Page 43  
Pricing 139



**LYDIA**  
Page 44  
Pricing 140



**LYONS**  
Page 46  
Pricing 141



**MACY**  
Page 48  
Pricing 142



**MARSHAL**  
Page 50  
Pricing 144



**MCKINLEY**  
Page 54  
Pricing 146



**MILAN**  
Page 55  
Pricing 147



**NEENAH**  
Page 56  
Pricing 148



**NILES**  
Page 59  
Pricing 150



**NOVI**  
Page 60  
Pricing 151

# INDEX CHAIRS & STOOLS



**PORTER**  
Page 62  
Pricing 153



**SAMARA**  
Page 64  
Pricing 154



**SELINA**  
Page 66  
Pricing 155



**SIDNEY**  
Page 67  
Pricing 156



**SITKA**  
Page 68  
Pricing 157



**TAYLOR**  
Page 70  
Pricing 158



**TIFFIN**  
Page 74  
Pricing 164



**TINLEY**  
Page 76  
Pricing 168



**WALTON**  
Page 78  
Pricing 169



**WARREN**  
Page 82  
Pricing 172



**WYLIE**  
Page 83  
Pricing 173



# LOUNGE, BENCHES & TABLES



**ARNOLD**  
Page 86  
Pricing 114



**BEREA**  
Page 87  
Pricing 117



**CLIVE**  
Page 88  
Pricing 123



**EDINA**  
Page 90  
Pricing 129



**LENEXA**  
Page 92  
Pricing 137



**MACY**  
Page 94  
Pricing 143



**OAKLEY**  
Page 95  
Pricing 152



**TAYLOR**  
Page 96  
Pricing 160



**TIFFIN**  
Page 98  
Pricing 167



**WALTON**  
Page 99  
Pricing 170



**OCCASIONAL**  
Page 102  
Pricing 122, 129, 163, 167



**COLLABORATION**  
Page 104  
Pricing 174



**MULTI-FUNCTIONAL**  
Page 106  
Pricing 175



# CHAIRS & STOOLS



# ADDI

## Chair and Stool



667



667-BS-30

Our hand woven leather strap back adds authentic character with a light aesthetic. The generous padded seat and form fitting backrest promises inviting comfort.

Available in Beech and Maple Wood

### Key Features

- Woven Leather Backrest
- Seamless U-Stretcher
- Steam Bent Back Posts
- Fixed and Motion Seat on Stools
- Solid Wood Corner Blocks
- Flex-O-Lator Spring Seats

### Available Options

- Nail trim on seat corners and back, specify in Brass 'BNT', Antique 'ANT', Stainless 'SNT', or Oxford 'ONT'
- Woven leather straps, specify Black 'BL', Burgundy 'BU', Brown 'BR', or Tan 'TA'
- Front leg casters on chairs, specify 'CA'
- 24" stool heights, specify '24'
- Brass channel standard, or specify in Stainless 'SSC'

## Chair with Arms and Stool with Motion



665



668-BS-30



nail trim

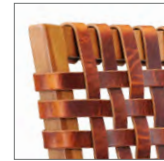

woven straps



brass channel

### DIMENSIONS

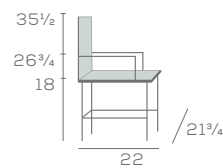
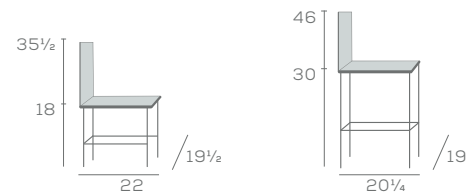



# AFTON

Bench and Stool



65-18



65-30

**Blend Afton in any environment with ease. The contoured seat allows personalization and multi-finish.**

Available in Maple and Oak Wood

Key Features

- Modern Design
- Contoured Seat
- Three Part H-Stretcher

Available Options

- Seat and frame in multi-finish
- Personalized laser engraved seat
- Personalized stamped seat
- 24" stool heights, specify '24'



stamp

## DIMENSIONS

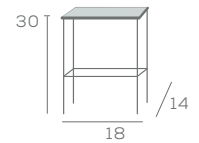
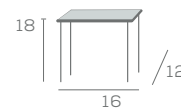

# ALLIS EAST

Chair and Stool



677UBS



677UBS-BS-30

A window frame backrest with soft radius edges and precise tailoring make Allis a clean, timeless chair. Select Allis East with a clean through backrest and layered wood-cushion seat. Select Allis West with a fully extended back and thicker, plush seat.



Chair with front leg casters

Chair with Arms



675UBS

## DIMENSIONS

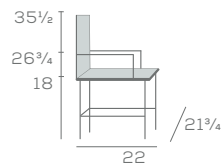
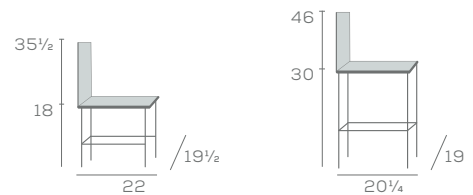
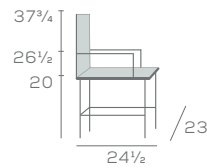
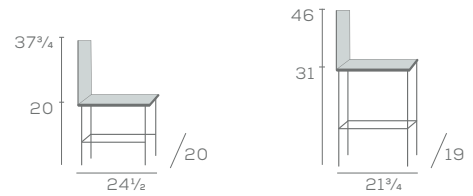

ALLIS  
WEST

Chair and Stool with Nail Trim



683UBS-NT



683UBS-BS-30-NT

Available in Beech and Maple Wood

Key Features

- Picture Frame Backrest
- Clean Through Design (East)
- Replaceable Seat (East)
- Seamless U-Stretcher
- Steam Bent Back Posts
- Solid Wood Corner Blocks
- Flex-O-Lator Spring Seats

Available Options

- Nail trim on seat corners and backrest, specify in Brass 'BNT', Antique 'ANT', Stainless 'SNT', or Oxford 'ONT'
- Handhold cutout on East models, specify 'HH'
- Front leg casters on chairs, specify 'CA'
- Piping in dual upholstery
- Dual upholstery on seat and backrest
- 24" stool height, specify '24'
- Brass channel standard, or specify in Stainless 'SSC'

Chair with Arms and Nail Trim



681UBS-NT

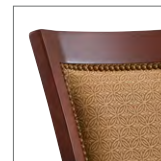

nail trim



handhold

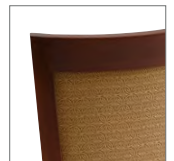

back view



casters



brass channel

# ASHER

## Chair and Stool



8663UBS-18



8663UBS-BS-30

**Asher provides a taste of mid-century and modernism with a crafted wood frame, soft corners, and simple aesthetic with the right detailing.**

Available in Maple Wood

### Key Features

- Contoured Backrest with Radius Edges
- Tapered Legs
- Stacking up to Four High
- Replaceable Seat and Backrest
- Front to Back Stretchers
- Steam Bent Parts
- Interlocking Solid Wood Corner Blocks

### Available Options

- 1" decorative buttons, specify 'DB'
- 24" Stool height, specify '24'
- Brass channel standard, or specify in Stainless 'SSC'

## Chair for Stacking



8667UBS-ST



Decorative buttons

Back view

## DIMENSIONS

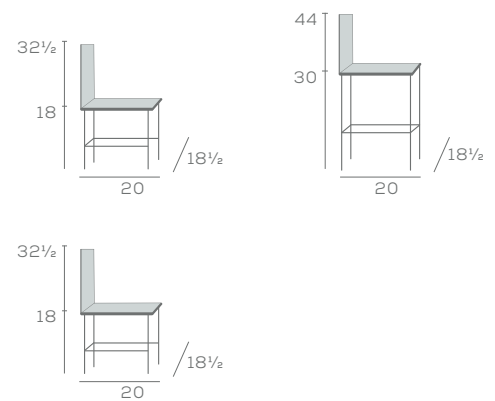



# BECKET

Chair and Stool



9838US



9838US-BS-30

Simple, clean lines with an exposed wood frame make Becket a versatile selection to complement any space. Choose between upholstery that wraps into the seat frame or a tailored seat pad.

Available in Maple & Oak Wood

Key Features

- Two Upholstered Seat Styles
- Clean Through Design
- Replaceable Seat
- Front to Back Stretchers
- Shaped Back Posts
- Interlocking Solid Wood Corner Blocks

Available Options

- Decorative stitching, specify 'DS'
- 24" stool height, specify '24'
- Brass channel standard, or specify in Stainless 'SSC'

Chair with Tailored Seat Pad



Decorative stitching



9833US

DIMENSIONS

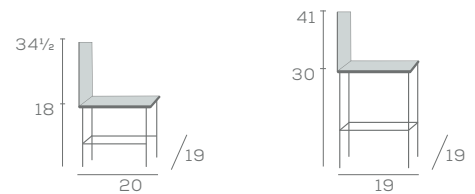

# BEXLEY

## Chair and Stool



233



233US-BS-30

**Engineered with a smile, Bexley's broad backrest rails intersect with an arc top to add a twist to an all wood classic.**

Available in Maple and Oak Wood

### Key Features

- Saddle or Upholstered Seat
- Replaceable Seat
- Bookshelf Stretcher
- Fixed and Motion Seats on Stools
- Steam Bent Parts
- Solid Wood Corner Blocks

### Available Options

- Nail trim on upholstered seat pad, specify in Brass 'BNT', Antique 'ANT', Stainless 'SNT', or Oxford 'ONT'
- Front leg casters on chairs, specify 'CA'
- 24" stool height, specify '24'
- Brass channel standard, or specify in Stainless 'SSC'



nail trim



brass channel

## Stool with Motion Seat



232-BS-30

## DIMENSIONS

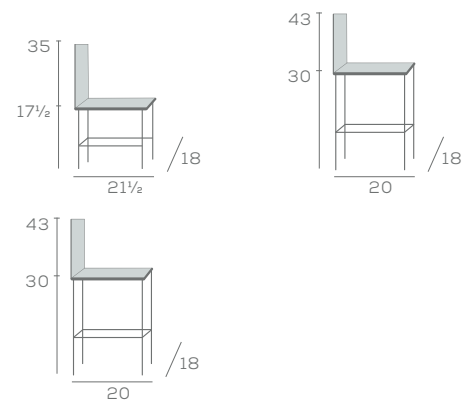

# BROOKS

Chair and Stool with Dual Upholstery



923

923-BS-30-DS

With a gently curved backrest, rounded seat, and decorative ring, Brooks bestows a gift from the past and legacy for the future.

Available in Maple Wood

Key Features

- Curved Solid Wood Backrest
- Metal Stretcher Ring
- Shaped Legs

Available Options

- Nail trim on seat edge and back, specify in Brass 'BNT', Antique 'ANT', Stainless 'SNT', or Oxford 'ONT'
- Decorative stitching, specify 'DS'
- Motion seat on all models, specify 'MO'
- Dual upholstery on outside of backrest
- Brass ring standard, or specify in Stainless 'SSR' and Black 'BLR'

Stool and Stool with Motion Seat



S-925-BS-30

S-925-BS-30-MO



DIMENSIONS

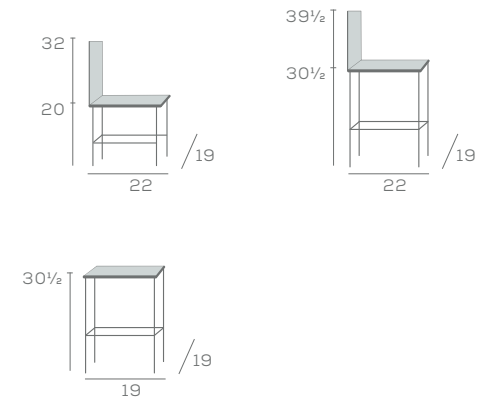

# CHELSEY

Chair and Stool



8803UBS-18



8803US-BS-30

Chelsey provides an abundance of options with an intricately routed backrest, classy apron shape, and tailored seat cushion.



Stacking at two high, up to five high

## DIMENSIONS

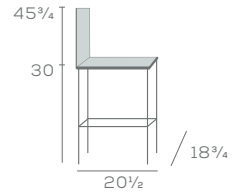
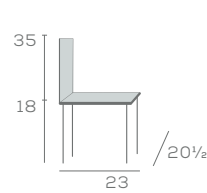

Chair with Arms



8801US

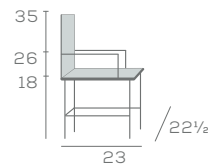
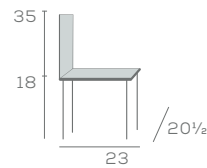
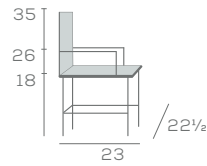



# CHELSEY

Chair for Stacking



8803US-18-ST

Available in Maple Wood

Key Features

- Intricately Routed Backrest
- Shaped Apron
- Replaceable Seat and Upholstered Backrest
- Tapered Legs
- Stacking up to Five High
- Steam Bent Back Posts
- Interlocking Solid Wood Corner Blocks

Available Options

- Ganging hardware, specify 'GGH'
- Exposed wood or upholstered backrest
- Brass channel standard, or specify in Stainless 'SSC'



ganging

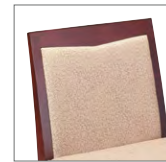

uph. backrest



brass channel

Chair with Arms for Stacking



8801US-ST

# CLAY

## Chair and Stool



511



511-BS-30

Clay exudes old world charm with handcrafted spindles made of premium hardwoods and meticulous detailing.

Available in Maple Wood

### Key Features

- Shaped Spindle Backrest and Legs
- Scallop Arm and Seat Design
- Saddle Seats with Beveled Edges
- Fixed and Motion Seat on Stools

### Available Options

- Upholstered seat pad with nail trim, specify in Brass 'BNT', Antique 'ANT', Stainless 'SNT', or Oxford 'ONT'
- Front leg casters on chairs, specify 'CA'
- Motion seat on stool with arms, specify '512' models
- Brass ring standard, or specify in Stainless 'SSR' or Black 'BLR'



motion seat



nail trim



brass ring

## Stool



S-513-30

## DIMENSIONS

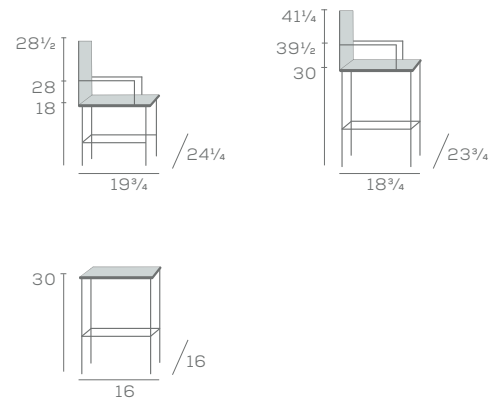

# BROOKS



A GIFT FROM THE PAST AND LEGACY FOR THE FUTURE,  
OPEN SPACES, AND A WELCOMING HABITAT;

THE BROOKS ESTATE, MASSACHUSETTS

# CLIVE

Chair and Chair with Arms

With classic form, Clive features soft corners, a unique scroll arm, and a studios presentation.



2003-18



2005US

## DIMENSIONS

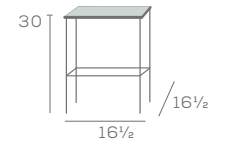
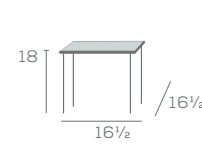
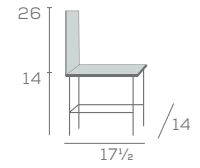
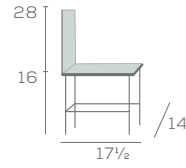
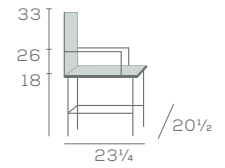
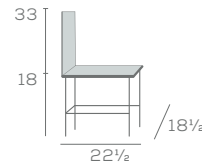

Chairs for Juvenile



2003-16



2003-14



# CLIVE

## Bench and Stool



S-2003US-18



S-2003US-30

Available in Maple and Oak Wood

### Key Features

- Contoured Back with Radius Edges
- Intricately Routed Backrest
- Scroll Arm
- Saddle or Upholstered Seat
- Replaceable Seats
- Bookshelf Stretcher
- Steam Bent Parts
- Solid Wood Corner Blocks
- Flex-O-Lator Spring Seats

### Available Options

- Ganging hardware, specify 'GGH'
- Front leg casters on chairs, specify 'CA'



bookshelf



ganging



scroll arm



Clive Lounge, page 88

# DAKOTA

Chair and Stool with Rectilinear Backrest



609

609-BS-30

**Tailored with comfort, Dakota has limitless application and universal appeal.**

Available in Maple and Oak Wood

**Key Features**

- Contoured Backrest with Radius Edges
- Clean Through Design
- Seamless U-Stretcher
- Steam Bent Parts
- Solid Wood Corner Blocks
- Flex-O-Lator Spring Seats

**Available Options**

- Nail trim on trapezoidal models along backrest boarder, specify in Brass 'BNT', Antique 'ANT', Stainless, 'SNT', or Oxford 'ONT'
- Sewn or piping on edges
- Piping in dual upholstery
- Replaceable seat, specify '605' and '607' models
- 24" stool height, specify '24'
- Brass channel standard, or specify in Stainless 'SSC'

Chair with Stool with Trapezoidal Backrest



603

603-BS-30

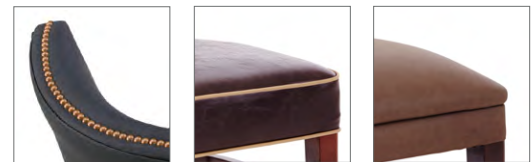

nail trim

piping

replace. seat

**DIMENSIONS**

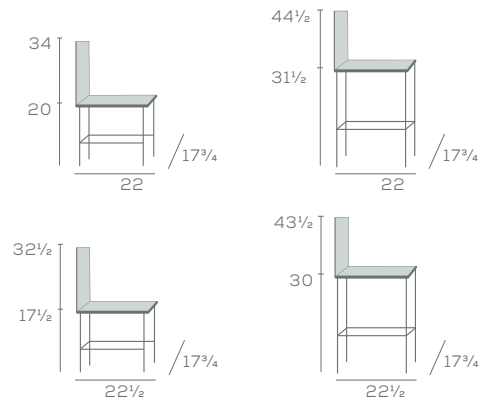

DECKER

Chair and Stool



453US



453US-BS-30

Decker brings to life a modern look of mission design. The all wood chair adds warmth and captures the beauty of this natural resource.

Available in Beech Wood

Key Features

- Clean Through Design
- Saddle and Upholstered Seat
- Replaceable Seat
- Seamless U-Stretcher
- Steam Bent Parts
- Solid Wood Corner Blocks

Available Options

- Wood or upholstered seat
- Seat and frame in multi-finish
- 24" stool height, specify '24'
- Brass channel standard, or specify in Stainless 'SSC'
- Personalized laser engraved backrest



wood seat

DIMENSIONS

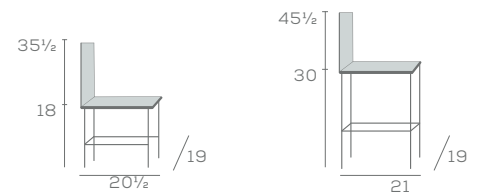

# DIEGO

Chair and Stool with Organic Shell Shape and Chrome 4-Leg Base



7500-NC-LBC



7500-NC-BS-30-LBC

The seven layered, bent ply shell is minimalism at its best. Choose from three unique shapes, two base options, and personalization to capture your brand essence.



Stacking



Custom metal finish

Chair and Stool with Curvilinear Shell Shape and Chrome Sled Base



7000-NC-SBC



7000-NC-BS-30-SBC

## DIMENSIONS

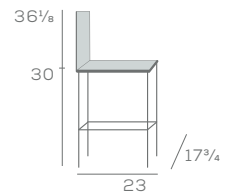
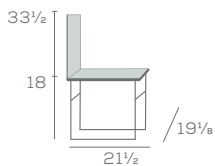
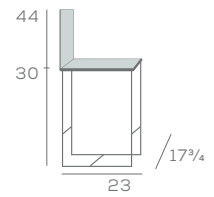
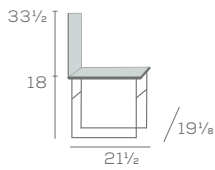
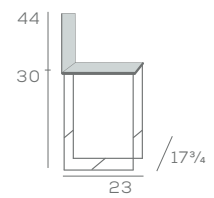
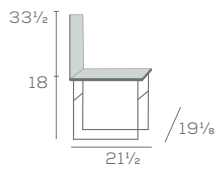
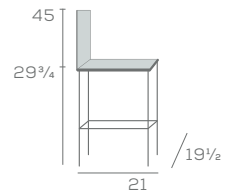
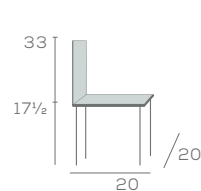



# DIEGO

Chair and Stool with Rectilinear Shell Shape and Black Sled Base



7200-NC-SBB



7200-NC-BS-30-SBB

Available in Beech and Maple Wood

Key Features

- Layered, Bent Ply Shell
- Three Unique Shapes
- Stacking up to Ten High
- Fully Upholstered Models
- Metal 4-Leg and Sled Bases
- Steam Bent Parts

Available Options

- Upholstered seat pad, specify 'US'
- Hook cutout, specify 'HK'
- Decorative cutouts, specify by shell shape
- 4-leg base in Chrome, specify 'LBC'
- Sled base in Chrome 'SBC' or Black 'SBB'
- Convenient dolly for ease of mobility
- Personalized laser engraved backrest
- Personalized cutouts
- Custom metal colors

Chair and Stool with Full Upholstery and Black Base



7200UBS-SBB



7200UBS-BS-30-LBB



organic back



partial cutout



full cutout



curvilinear back



partial cutout



full cutout



rectilinear back



partial cutout



full cutout



low back stool



hook cutout



uph. seat pad

# DOLTON

## Chair and Stool



623



623-BS-30

Dolton utilizes clean, geometric lines and an appealing crosswise stretcher. Select from standard arm and armless seating options or upholstered backless benches. Either direction, you'll enjoy superior comfort.

## DIMENSIONS

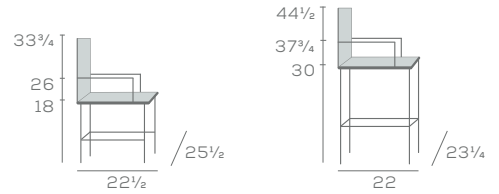
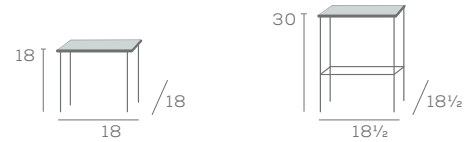
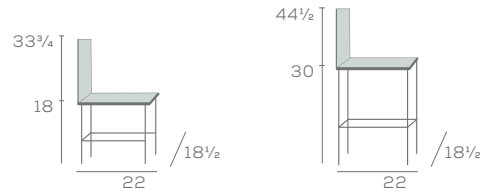

## Bench and Stool



S-623-18



S-623-30

# DOLTON

Chair and Stool with Arms



621



623-BS-30-A

Available in Beech and Maple Wood

Key Features

- Clean Through Design
- Crosswise Stretcher
- Interlocking Solid Wood Corner Blocks
- Flex-O-Lator Spring Seats

Available Options

- Piping in dual upholstery
- Dual upholstery on seat and backrest
- Front leg casters on chairs, specify 'CA'
- 24" stool height, specify '24'
- Brass channel standard, or specify in Stainless 'SSC'



piping



dual uph.



brass channel

# EDINA

Chair and Chair with Arms



5663US-18



5661US

**Edina displays a mission design aesthetic with a multitude of options and superior wood construction.**

Available in Maple and Oak Wood

**Key Features**

- Intricately Routed Backrest
- Clean Through Design
- Saddle and Upholstered Seats
- Replaceable Seats
- Bookshelf Stretcher
- Solid Wood Corner Blocks
- Flex-O-Lator Spring Seats

**Available Options**

- Wood or upholstered seat
- Two backrest designs
- Decorative cutout, specify '3S'



wood seat

backrest

cutout

Chairs for Juvenile



5663-16



5663-14

**DIMENSIONS**

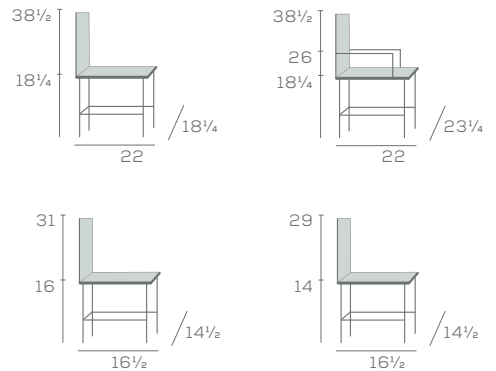

Edina Lounge, page 90



# ELLANOR

Chairs with Multiple Backrest Styles



5813



5833US

Accentuate any room with Ellanor's taller back height and distinguished style crafted of premium oak hardwood.

Available in Oak Wood

Key Features

- Four Distinct Backrest Designs
- Clean Through Design
- Saddle and Upholstered Seat
- Replaceable Seat
- Multifaceted Stretcher
- Solid Wood Corner Blocks
- Flex-O-Lator Spring Seat

Available Options

- Upholstered seat pad with nail trim, specify in Brass 'BNT', Antique 'ANT', Stainless 'SNT', or Oxford 'ONT'
- Wood or upholstered seat

Chairs with Multiple Backrest Styles



5705



5706US

## DIMENSIONS

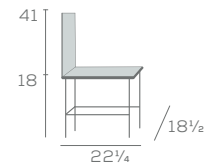
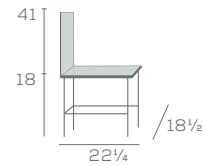
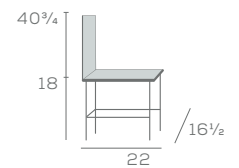
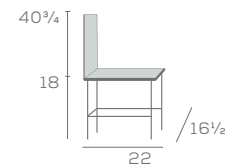

# HANA



MANY WINDING CURVES THAT JOURNEY THROUGH HISTORIC  
BRIDGES, WATERFALLS, LUSH RAINFORESTS, AND THE HEART OF THE STATE;

THE HANA HIGHWAY, HAWAII

# HANA

Chair and Stool



883



883-BS-30

**Attractive lines blend with soft curves to invoke a sense of comfort and relaxation. Keep the conversation flowing with Hana.**

Available in Maple Wood

**Key Features**

- Upholstered Bent Ply Backrest
- Tapered Legs
- Three Part H-Stretcher
- Interlocking Solid Wood Corner Blocks
- Flex-O-Lator Spring Seats

**Available Options**

- Dual upholstery on backrest
- 24" stool height, specify '24'
- Brass channel standard, or specify in Stainless 'SSC'

**DIMENSIONS**

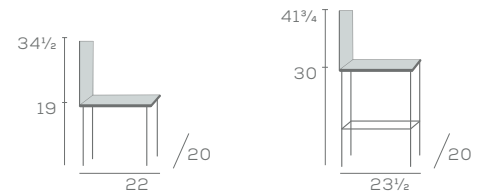

# HAYS EAST

Chair and Stool



713



713-BS-30

The choice between a plush, fully upholstered backrest and seat, Hays East, or a unique window backrest for a light aesthetic, Hays West.

## DIMENSIONS

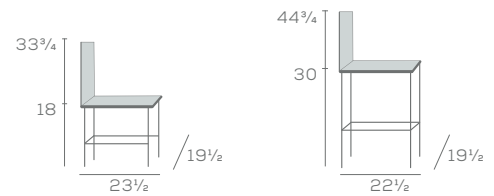
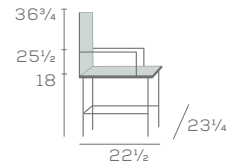
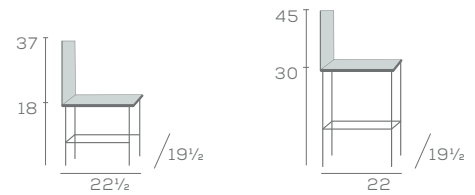

Chair with Arms



711

HAYS  
WEST

Chair and Stool



703



703-BS-30

Available in Beech and Maple Wood

Key Features

- Window Backrest
- Clean Through Design
- Front to Back Stretchers
- Interlocking Solid Wood Corner Blocks
- Flex-O-Lator Spring Seats

Available Options

- Dual upholstery on backrest
- 24" stool height, specify '24'
- Brass channel standard, or specify in Stainless 'SSC'



View of window backrest



# JOLIET

Chair and Stool



9903



9903-BS-30

Inspired alongside the industrial revolution, Joliet has an expanded offering with several enhancements. Featuring plush, tailored upholstery with a scalloped seat front for unexpected comfort. Elevate traditional settings or juxtaposition modern-day with yesteryear.



Back view

Chair with Arms and Casters



9901



9901-CA

## DIMENSIONS

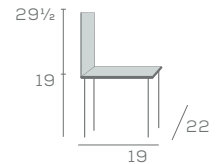
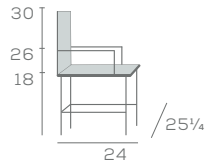
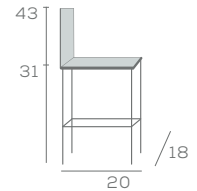
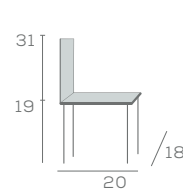

# JOLIET

Chair with Fully Upholstered Backrest



9933

Available in Maple Wood

#### Key Features

- Contoured Backrest with Radius Edges
- Scalloped Seat Shape
- Tapered Legs
- Steam Bent Parts
- Interlocking Solid Wood Corner Blocks
- Flex-O-Lator Spring Seats

#### Available Options

- Nail trim on seat corners and backrest, specify in Brass 'BNT', Antique 'ANT', Stainless 'SNT', or Oxford 'ONT'
- Piping in dual upholstery
- Dual upholstery on backrest
- Front leg casters on chairs, specify 'CA'
- 24" stool height, specify '24'
- Brass channel standard, or specify in Stainless 'SSC'



nail trim



nail trim



piping

# KOKO

Chair and Stool



9633



9633-BS-30

**Reinventing the classic dining chair - where beauty is visible at all time, while being used or nested at the table. An expert blend of wood and fabric with seamless flow, Koko was created to enhance the ambiance.**

Available in Maple Wood

#### Key Features

- Blended Wood and Upholstered Backrest
- Tapered Backrest Shape
- Three Part H-Stretcher
- Interlocking Solid Wood Corner Blocks
- Flex-O-Lator Spring Seats

#### Available Options

- Piping in dual upholstery
- Dual upholstery on backrest
- 24" stool height, specify '24'
- Brass channel standard, or specify in Stainless 'SSC'



Side view

#### DIMENSIONS

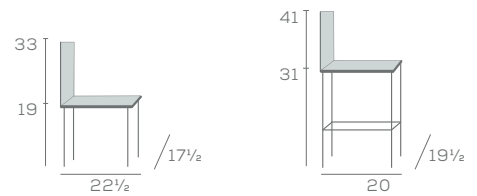

# LARK

Chair and Stool



7123UBS-DS



7123UBS-BS-30-DS

Inspired to allure, Lark brings together refined form and function. The light, airy aesthetic provides a clean through design and handhold feature. The thin seat is enclosed by a wood frame and detailed with radius corners.

Available in Maple Wood

Key Features

- Tailored Seat that Wraps into the Frame
- Integrated Handhold Design
- Clean Through Design
- Radius Apron and Edges
- Tapered Legs
- Front to Back Stretchers
- Shaped Back Posts
- Interlocking Solid Wood Corner Blocks

Available Options

- Decorative stitching, specify 'DS'
- Dual upholstery on backrest
- 24" stool height, specify '24'
- Brass channel standard, or specify in Stainless 'SSC'



Dual upholstery on backrest

DIMENSIONS

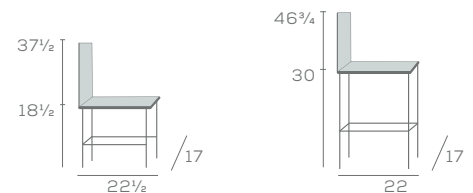

# LORA

## Chair and Stool with Layered Backrest



9827US

9827US-BS-30

Create a harmonious, planate environment with Lora. Select a more artisan look with the layered, plank backrest or a more refined look with the inset backrest. Both exude the character and warmth of wood.

Available in Beech Wood

### Key Features

- Layered and Inset Backrest Designs
- Shaped Apron
- Clean Through Design
- Shaped Back Posts
- Steam Bent Parts
- Interlocking Solid Wood Corner Blocks
- Flex-O-Lator Spring Seats

### Available Options

- 24" stool height, specify '24'
- Brass channel standard, or specify in Stainless 'SSC'

## Chair and Stool with Inset Backrest



9823US

9823-BS-30

## DIMENSIONS

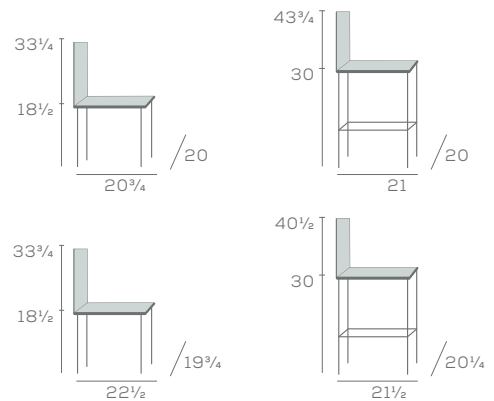



# LOUIE

Chair and Stool



583



583-BS-30

**Simple and distinguished. Louie offers tapered legs, a tailored seat, and handwoven backrest.**

Available in Maple Wood

**Key Features**

- Woven 2" Vinyl Strap Backrest
- Clean Through Design
- Tapered Legs
- Steam Bent Parts
- Interlocking Solid Wood Corner Blocks
- Flex-O-Lator Spring Seats

**Available Options**

- Woven straps specified in choice of vinyl
- 24" stool height, specify '24'
- Brass channel standard, or specify in Stainless 'SSC'



Back view

**DIMENSIONS**

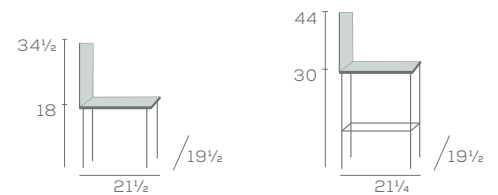

# LYDIA

Chair and Chair with Arms



653



657

Lydia was conceived as an all wood chair, distinguished by an arc ladder back and tapered legs. Then, bring your vision to life with a mix of upholstery options.

## DIMENSIONS

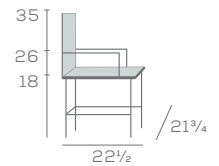
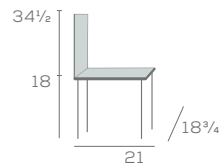
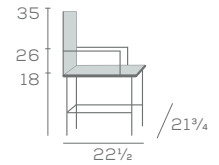
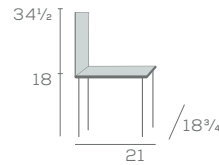
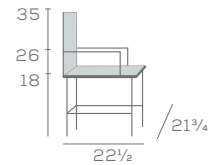
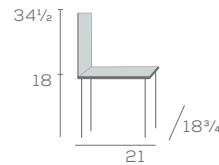
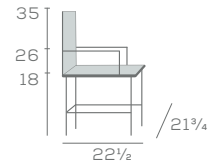
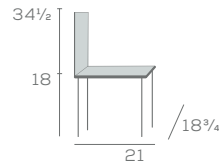

Chair and Chair with Arms and Upholstered Seat



653US



657US

# LYDIA

Chair and Chair with Arms with Upholstery and Handhold



655UBS



659UBS

Available in Maple Wood

Key Features

- Ladder and Picture Frame Backrests
- Contoured Back with Radius Edges
- Integrated Handhold Design
- Clean Through Design
- Saddle and Upholstered Seats
- Replaceable Seats
- Tapered Legs
- Steam Bent Parts
- Interlocking Solid Wood Corner Blocks
- Flex-O-Lator Spring Seats

Available Options

- Wood or upholstered seats



uph. seat



handhold



clean through

Chair and Chair with Arms with Upholstery and Clean Through



654UBS



658UBS

# LYONS

## EAST

Chair and Stool



7933



7933-BS-30

With three artfully crafted backrest designs, Lyons captures solid wood construction at its best. Personalize with upholstery and unique options.

### DIMENSIONS

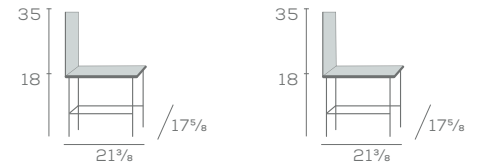
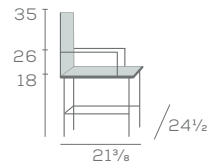
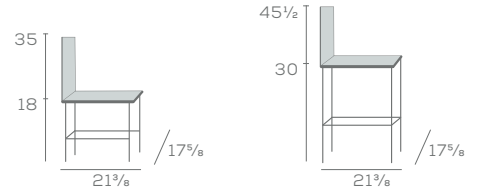

Chair with Arms



7931US

LYONS  
WEST

Chairs with Multiple Backrest Styles



7983



7963

Available in Maple and Oak Wood

Key Features

- Intricately Routed Backrest Designs
- Clean Through Design
- Radius Apron
- Saddle and Upholstered Seat
- Replaceable Seats
- Tapered Legs
- Front to Back Stretchers
- Exposed Solid Wood Frame
- Steam Bent Parts
- Interlocking Solid Wood Corner Blocks
- Flex-O-Lator Spring Seats

Available Options

- Three backrest designs
- Wood or upholstered backrest
- Wood or upholstered seat
- Decorative cutout, models 7933, specify 'C'
- Front leg casters on chairs, specify 'CA'



cutout



uph. backrest



uph. backrest



# MACY EAST

Chair and Stool



953-DSG



9803-BS-30

A clean, modern look with tapered backrest and tailored cushions. Select Macy East with layered wood-upholstered seats. Select Macy West with plush, fully upholstered seats. Finalize your design with stitching details. Macy coexists in spaces with a warm, relaxed sense of familiarity.

## DIMENSIONS

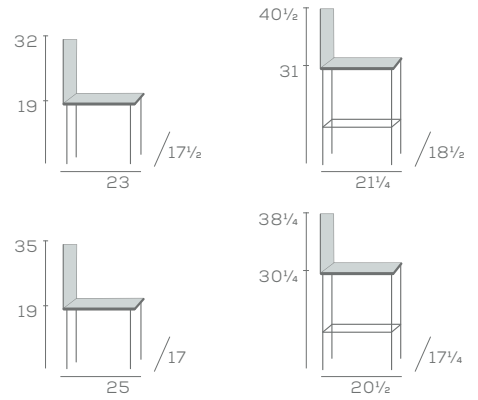

MACY  
WEST

Chair and Stool



833



9805-BS-30

Available in Maple Wood

Key Features

- Tapered Legs and Backrest
- Interlocking Solid Wood Corner Blocks
- Flex-O-Lator Spring Seats

Available Options

- Decorative stitching, specify Grid 'DSG' or Line 'DSL'
- Dual upholstery on backrest
- 24" stool height, specify '24'
- Brass channel standard, or specify Stainless 'SSC'



grid stitch



line stitch

Stool



S-9802-30



Macy Lounge, page 94

# MARSHAL EAST

Chair and Stool with Trapezoidal Backrest



9556



9556-BS-30

**A modern, workaday solution. Choose Marshal East with attached backrest styles and cafe scale or Marshal West with integrated backrest styles and standard scale. Then add your touch of personalization.**

## DIMENSIONS

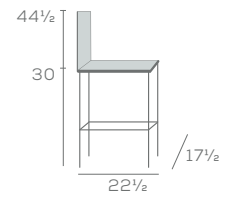
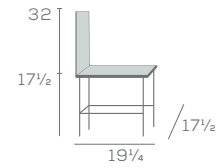
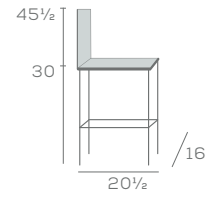
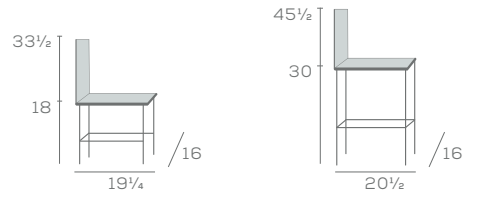

Chair and Stool with Elliptical Backrest



1800



1800-BS-30

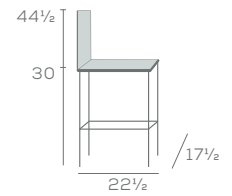
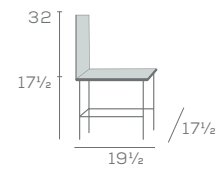

# MARSHAL EAST

Chairs and Stool with Rectangular Backrest



1900



1900-BS-30

Available in Maple and Oak Wood

Key Features

- Contoured Backrest in Three Shapes
- Clean Through Design
- Cafe Scale
- Saddle and Upholstered Seat
- Replaceable Seat
- Tapered Legs
- Seamless U-Stretcher
- Exposed Solid Wood Frame
- Steam Bent Parts
- Solid Wood Corner Blocks

Available Options

- Wood or upholstered seats
- Decorative cutout on trapezoidal backrest, specify 'C'
- Seat/backrest and frame in multi-finish
- 24" stool height, specify '24'
- Brass channel standard, or specify in Stainless 'SSC'
- Personalized laser engraved seat or backrest



uph. seat



cutout



engraving



dual finish



Marshall West continues >

# MARSHAL WEST

Chair and Stool with Trapezoidal Backrest



436-C



436US-BS-30-C

**A modern, workaday solution. Choose Marshal East with attached backrest styles and cafe scale or Marshal West with integrated backrest styles and standard scale. Then add your touch of personalization.**

## DIMENSIONS

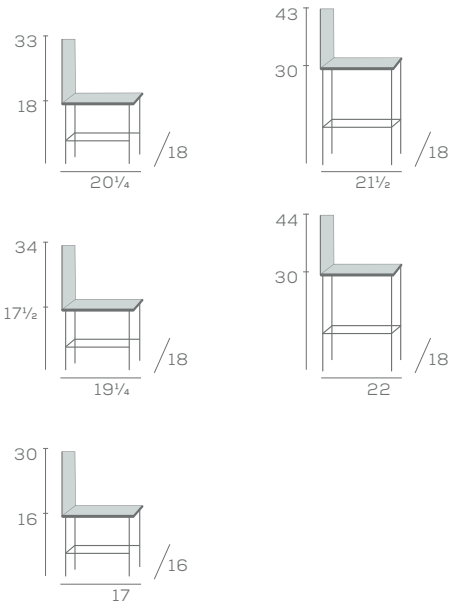



# MARSHAL WEST

Chair and Stool with Arc Backrest



433-18-3L



435-BS-30

Available in Maple and Oak Wood

Key Features

- Contoured Backrest in Two Shapes
- Clean Through Design
- Saddle and Upholstered Seat
- Replaceable Seat
- Tapered Legs
- Seamless U-Stretcher
- Exposed Solid Wood Frame
- Steam Bent Parts
- Solid Wood Corner Blocks

Available Options

- Wood or upholstered seats and backrest
- Decorative cutout on trapezoidal backrest, specify 'C' or '3C'
- Decorative cutout on arc backrest, specify '3L'
- Rail backrest on trapezoidal models, specify '1600' or '1700'
- 24" stool height, specify '24'
- Brass channel standard, or specify in Stainless 'SSC'
- Personalized laser engraved seat or backrest

Chair for Juvenile



435UBS-16



uph. seat



uph. backrest



engraving



backrest '3C'



backrest '1600'



backrest '1700'

# MCKINLEY

## Chair and Stool



1303



1303-BS-30

**Mckinley bestows a premium wood picture-frame backrest design with scroll top for traditional to transitional environments.**

Available in Maple and Oak Wood

### Key Features

- Picture Frame Backrest with Scroll Top
- Clean Through Design
- Replaceable Seat
- Three Part H-Stretcher
- Steam Bent Back Posts
- Fixed and Motion Seats on Stools
- Interlocking Solid Wood Corner Blocks
- Flex-O-Lator Spring Seats

### Available Options

- Traditional detailing, scroll arms and molding, specify '1305', '1307', and '1304' models
- Decorative crosswise back detail, specify 'XBA'
- Dual upholstery on backrest
- Front leg casters on chairs, specify 'CA'
- Four leg casters on chairs, specify 'CA4'
- 24" stool height, specify '24'
- Brass channel standard, or specify in Stainless 'SSC'

## Chair with Arms and Stool with Motion Seat



1301



1302-BS-30



trad. arm

trad. detailing

crosswise back

## DIMENSIONS

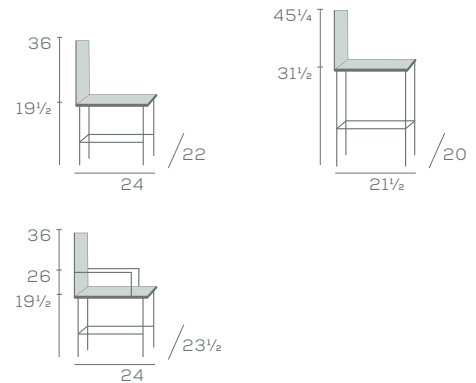

MILAN

Chair and Stool



7833US



7833US-BS-30

A modern day Victorian style, Milan was designed to elevate any room with high quality aesthetic and performance. Brilliant joinery of the ladder-back with steam bent, shaped legs intersect a plush fitted seat bidding everyday glamour.

Available in Maple Wood

Key Features

- Intricately Routed Backrest
- Contoured Backrest with Radius Edges
- Steam Bent Shaped Legs
- Front to Back Stretchers
- Interlocking Solid Wood Corner Blocks
- Flex-O-Lator Spring Seats

Available Options

- Decorative sewn seat, specify 'SS'
- 24" stool height, specify '24'
- Brass channel standard, or specify in Stainless 'SSC'

Stool



S-7933US-30



sewn seat

backrest

leg/seat detail

DIMENSIONS

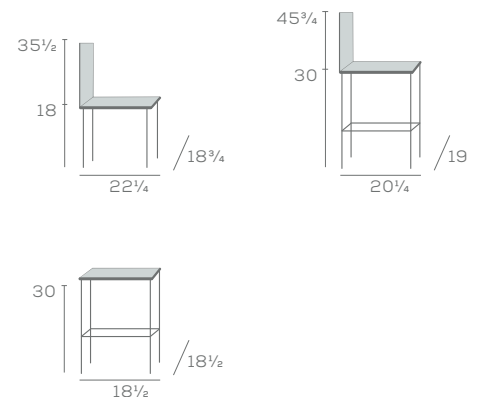

# NEENAH EAST

Chair and Stool with Panel Backrest



547US



547US-BS-30

Reach broad appeal with Neenah. Select the arched backrest styles found in Neenah East or the straight backrest styles of Neenah West. Personalize with a variety of options and unique combinations.



Upholstered backrest

## DIMENSIONS

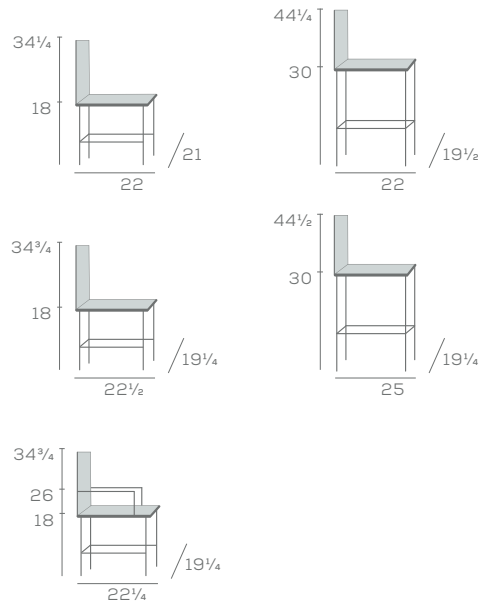

# NEENAH EAST

Chair and Stool with Ladder Backrest



533US

533US-BS-30

Available in Beech and Maple Wood

Key Features

- Panel or Ladder Backrest
- Clean Through Design
- Replaceable Seat
- Three Part H-Stretcher
- Shaped Legs and Back Posts
- Steam Bent Parts
- Solid Wood Corner Blocks
- Flex-O-Lator Spring Seats

Available Options

- Front leg casters on chairs, specify 'CA'
- Brass channel standard, or specify in Stainless 'SSC'
- Personalized laser engraving on panel backrest models

Chair with Arms



531US



Neenah West continues >

# NEENAH WEST

## Chair and Stool



543UBS-TC



543UBS-BS-30-TC

Reach broad appeal with Neenah. Select the arched backrest styles found in Neenah East or the straight backrest styles of Neenah West. Personalize with a variety of options and unique combinations.

Available in Beech and Maple Wood

### Key Features

- Window Backrest
- Clean Through Design
- Replaceable Seat
- Three Part H-Stretcher
- Shaped Legs and Back Posts
- Steam Bent Parts
- Solid Wood Corner Blocks
- Flex-O-Lator Spring Seats

### Available Options

- Wood panel or upholstered cutout backrest
- Front leg casters on chairs, specify 'CA'
- Brass channel standard, or specify in Stainless 'SSC'
- Personalized laser engraving on panel back

## Chair with Arms



541UBS-TC



back view

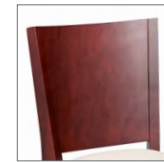

panel back

## DIMENSIONS

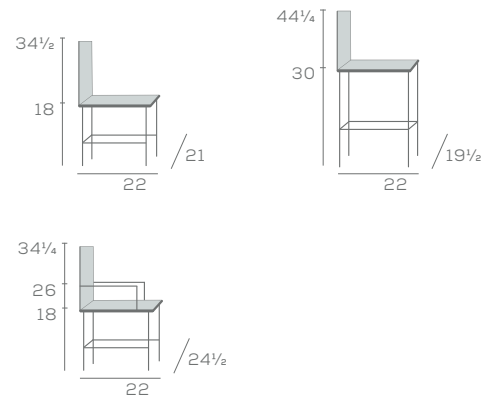



# NILES

Chair and Stool



553US



553US-BS-30

With an exposed frame of premium wood and distinctive woven cane backrest, Niles is sure to create a lasting impression.

Available in Beech and Maple Wood

Key Features

- Woven Cane Backrest Reinforced with Metal Ribbing for Superior Strength and Shape Retention
- Clean Through Design
- Three Part H-Stretcher
- Shaped Back Posts and Legs
- Steam Bent Parts
- Solid Wood Corner Blocks
- Flex-O-Lator Spring Seats

Available Options

- Upholstered backrest panel
- Front leg casters on chairs, specify 'CA'
- 24" stool height, specify '24'
- Brass channel standard, or specify in Stainless 'SSC'

Chair with Arms



551US



uph. backrest



brass channel

DIMENSIONS

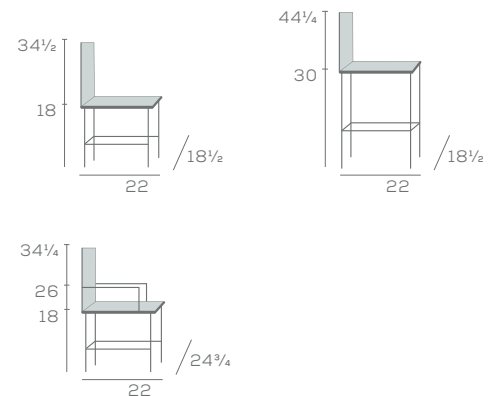

# NOVI

## Chair and Stool



7303UBS



7303UBS-BS-30

Novi casts an array of appeal with a light, shapely aesthetic. The contoured backrest and generous seat provide unparalleled comfort. The offering includes vast amenities – mobility, stacking, nail trim, armpad, and bariatric selections.



Stacking at three high, up to five high

## Chair for Stacking



7303UBS-ST

## DIMENSIONS

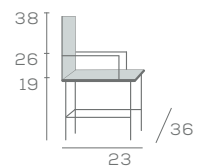
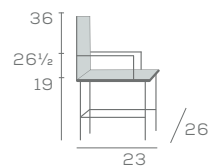
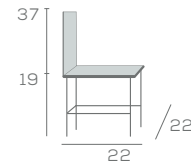
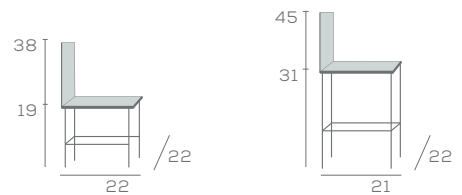

NOVI

Chair with Arms and Casters



7301UBS

7301UBS-CA

Available in Beech and Maple Wood

Key Features

- Contoured Backrest
- Scroll Arm Detail
- Replaceable Seat
- Stacking up to Five High
- Shaped Back Posts
- Interlocking Solid Wood Corner Blocks
- Flex-O-Lator Spring Seats

Available Options

- Nail trim on backrest, specify in Brass 'BNT', Antique 'ANT', Stainless 'SNT', or Oxford 'ONT'
- Armpad cushion, specify 'AP'
- Front leg casters on chairs, specify 'CA'
- Brass channel standard, or specify in Stainless 'SSC'



nail trim



armpad



casters

Chair with Arms for Bariatric



7301UBS-BA

# PORTER

Chair



863

An all wood chair rich in detail. Select single or dual tone finish with a range of colors to fit your brand essence. Porter celebrates the beauty of wood, Scandinavian influence, and features a crosswise stretcher for strength and enhanced aesthetic.



Seat/backrest and frame in multi-finish

Chair with Upholstery and Handhold



863UBS



863UBS-HH

## DIMENSIONS

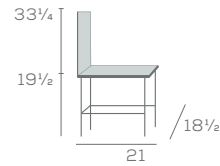
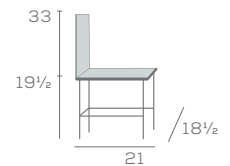
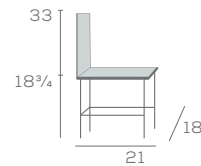

# PORTER

Chair with Upholstered Seat



863US

Available in Maple Wood

Key Features

- Steam Bent Ply Backrest
- Clean Through Design
- Saddle and Upholstered Seat
- Tapered and Radius Legs
- Crosswise Stretcher
- Interlocking Solid Wood Corner Blocks
- Flex-O-Lator Spring Seats

Available Options

- Wood or upholstered seat
- Handhold on upholstered backrest, specify 'HH'
- Seat/backrest and frame in multi-finish



handhold



multi-finish

# SAMARA

Chair and Stool



835



839-BS-30

**Contemporary, yet warm and inviting. Samara is fitted with a gently sloped, wing arm and tall backrest for privacy, comfort, and distinction.**

Available in Maple Wood

Key Features

- Stately Backrest with Wing Arms
- Tapered Legs
- Steam Bent Back Posts
- Interlocking Solid Wood Corner Blocks
- Flex-O-Lator Spring Seats

Available Options

- Dual upholstery on backrest and arms



Dual upholstery

---

DIMENSIONS

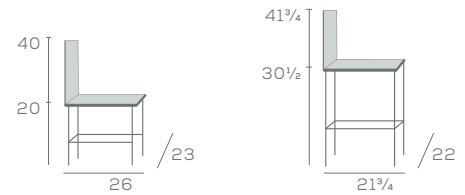



# SAMARA



DESIGNED AS IF THEY WERE GUESTS OF THE FAMILY, AS AN  
EDUCATIONAL WORK OF ART, AS AN EPONYM OF A WINGED SEED;

THE SAMARA HOUSE, INDIANA

# SELINA

Chair and Stool



693



693-BS-30

**Originality to exquisite taste, Selina displays a tall backrest complete with a posh, rolled top. Decorate with nail trim to your specification.**

Available in Oak Wood

**Key Features**

- Stately Backrest with Rolled Top
- Multifaceted Stretcher
- Interlocking Solid Wood Corner Blocks
- Flex-O-Lator Spring Seats

**Available Options**

- Nail trim on seat boarder, specify in Brass 'BNT', Antique 'ANT', Stainless 'SNT', or Oxford 'ONT'
- Dual upholstery on backrest or seat/backrest
- 24" stool height, specify '24'
- Brass channel and ring standard, or specify in Stainless 'SSC'/'SSR'

Stool



S-693US-30



**DIMENSIONS**

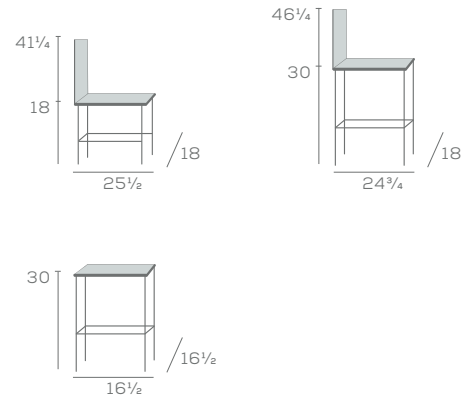

# SIDNEY

Chair and Stool



613



613-BS-30

With gentle curves and shapely features, Sidney imparts understated elegance. A contoured backrest and soft, generous seat invoke satisfying comfort.

Available in Beech and Maple Wood

Key Features

- Stately Backrest with Arched Top
- Clean Through Design
- Front to Back Stretchers
- Steam Bent Back Posts
- Interlocking Solid Wood Corner Blocks
- Flex-O-Lator Spring Seats

Available Options

- Armpad cushion, specify 'AP'
- Curve or scroll arm shape
- Front leg casters on chairs, specify 'CA'
- 24" stool height, specify '24'
- Brass channel standard, or specify in Stainless 'SSC'

Chair with Arms



611



armpad



scroll arm



casters

DIMENSIONS

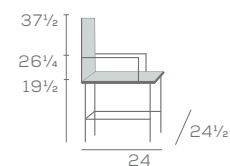
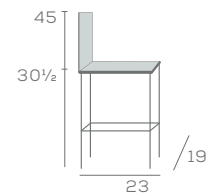
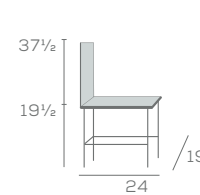

# SITKA EAST

Chair and Stool



643



643-BS-30

Sitka bids abundant charm with a shapely top, crisp tailoring, decorative legs, and elegant nail trim. Select Sitka East with upholstered backrest or Sitka West with wood crown.

## DIMENSIONS

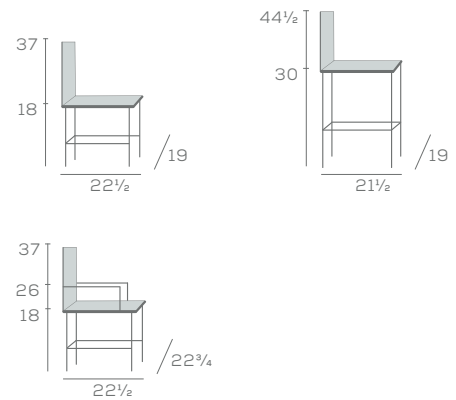

Chair with Arms



641

SITKA  
WEST

Chair and Stool



647



647-BS-30

Available in Beech and Maple Wood

Key Features

- Shapely Backrest
- Wood Crown Backrest with Handhold
- Tufted upholstery
- Gently Rounded Edges
- Clean Through Design
- Interlocking Solid Wood Corner Blocks
- Flex-O-Lator Spring Seats

Available Options

- Nail trim, East models, specify in Brass 'BNT', Antique 'ANT', Stainless 'SNT', or Oxford 'ONT'
- Armpad cushion, specify 'AP'
- Front leg casters on chairs, specify 'CA'
- 24" stool height, specify '24'
- Brass channel standard, or specify in Stainless 'SSC'



nail trim (east)



tufting (west)



armpad

Chair with Arms



649

# TAYLOR EAST

Chair and Stool with Sled Base



776-SB-18



773UBS-SB-28

The ever timeless Taylor offers an abundance of choices in either sled or 4-leg models. Select Taylor East with elevated front-stretcher and stool options. Or select Taylor West with a waterfall seat and 2-position and 3-position models.

## DIMENSIONS

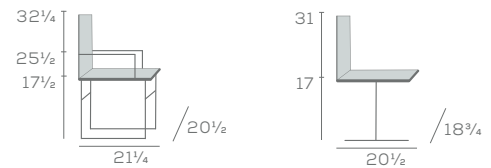
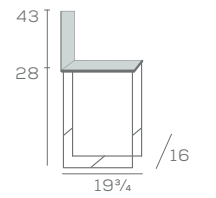
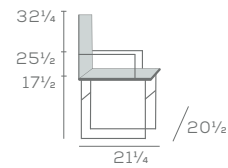
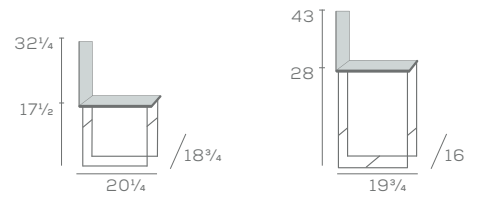

Chair with Arms and Swivel Base



778UBS-SB



777UBS

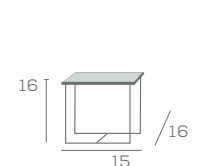
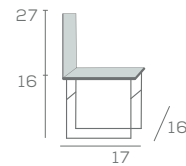
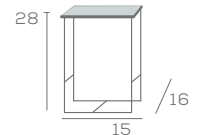
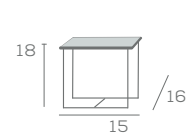



TAYLOR  
EAST

Bench and Stool



S-773-SB-18



S-773US-SB-28

Available in Maple and Oak Wood

Key Features

- Sled and 4-Leg Bases
- Clean Through Design
- Saddle and Upholstered Seat
- Replaceable Seats
- Side-to-Side Stretchers
- Exposed Solid Wood Frame
- Solid Wood Corner Blocks
- Flex-O-Lator Spring Seats

Available Options

- Sled and 4-leg bases
- Wood or upholstered seats and backrest
- Ganging hardware, specify 'GGH'
- Personalized laser engraved seat or backrest



Chair models in 4-leg bases

Chair and Bench for Juvenile



776-SB-16



S-773-SB-16



Taylor West continues >

# TAYLOR WEST

Chair and Chair with Arms and Sled Base



173UBS-SB-18



171UBS-SB

The ever timeless Taylor offers an abundance of choices in either sled or 4-leg models. Select Taylor East with elevated front-stretcher and stool options. Or select Taylor West with a waterfall seat and 2-position and 3-position models.

## DIMENSIONS

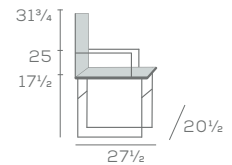
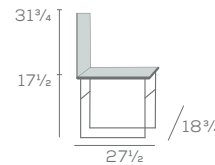
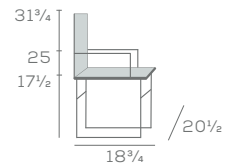
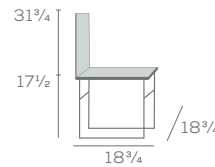
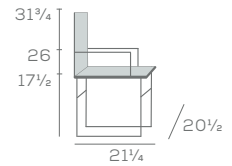
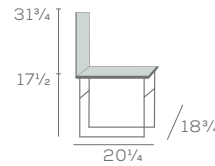

Chair and Chair with Arms and 2-Position Base



177-18



175UBS

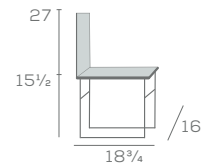
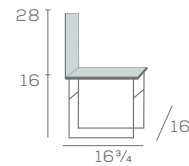

TAYLOR  
WEST

Chair and Chair with Arms and 3-Position Base



3-177US-18



3-175UBS

Available in Maple and Oak Wood

Key Features

- Sled and 4-Leg Base
- Clean Through Design
- Saddle and Upholstered Seat
- Side-to-Side Stretchers
- Exposed Solid Wood Frame
- Solid Wood Corner Blocks
- Flex-O-Lator Spring Seats

Available Options

- Sled and 4-leg bases
- Wood or upholstered seats and backrest
- Ganging hardware, specify 'GGH'
- Personalized laser engraved seat or backrest



Chair models in 4-leg bases

Chairs for Juvenile



173-SB-16



177UBS-16



Taylor Lounge, page 96  
Taylor Tables, page 103

# TIFFIN

Chair and Stool



973-SB-18



973UBS-SB-28

The ever popular Tiffin features a beautifully arched backrest, bullnose edge detail, and back footrest stretcher. Choose models in any upholstery combination, and sled, 4-leg, 2-position, and 3-position bases.

## DIMENSIONS

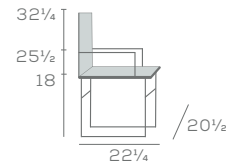
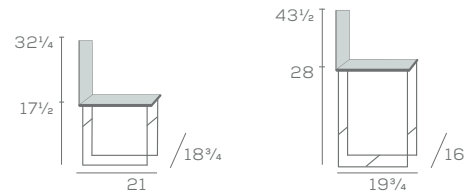

Chair with Arms



971UBS-SB

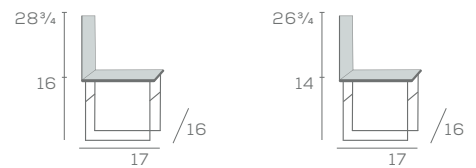
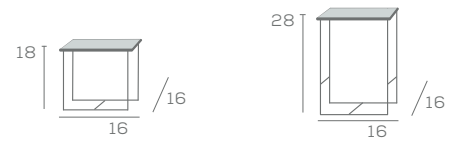

TIFFIN

Bench and Stool



S-973US-SB-18



S-973US-SB-28

Available in Maple and Oak Wood

Key Features

- Sled and 4-Leg Base
- Clean Through Design
- Saddle and Upholstered Seat
- Footrest Stretcher
- Exposed Solid Wood Frame
- Solid Wood Corner Blocks
- Flex-O-Lator Spring Seats

Available Options

- Sled and 4-leg bases
- Wood or upholstered seats and backrest
- Ganging hardware, specify 'GGH'
- Personalized laser engraved seat or backrest



Chair models in 4-leg base

Chairs for Juvenile



973UBS-SB-16



973UBS-SB-14



Tiffin Lounge, page 98  
Tiffin Tables, page 103

# TINLEY

Chair and Stool



2200-20



2200-20-BS-30-3L

The ever loved Tinley features a shaped ply backrest and seat and steam bent leg design. Choose models in any upholstery combination and sled, 4-leg, 2-position, and 3-position bases.

## DIMENSIONS

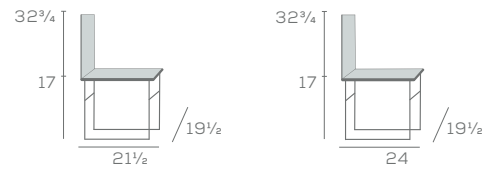
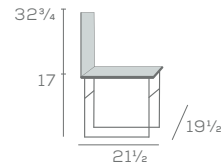
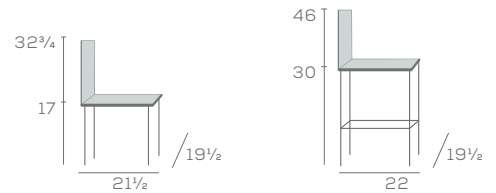



# TINLEY

Chair with Sled Base



2204UB-20

Available in Beech Veneer

Key Features

- Sled, 4-Leg, Two & Three Position Bases
- Waterfall Seat Design
- Clean Through Design
- 21-Ply Hard Maple Lamination
- Stacking up to Five High
- Saddle and Upholstered Seat
- Side-to-Side Stretcher
- Steam Bent Parts

Available Options

- Sled, 4-leg, two & three position bases
- Wood or upholstered seats and backrest
- Decorative cutout, specify '3L'
- Ganging hardware, specify 'GGH'
- Seat/backrest and frame in multi-finish
- Personalized laser engraved seat or backrest

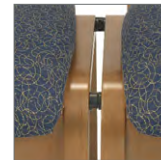

ganging

Chairs with 2-Position and 3-Position Base



2202UBS-20



2203UBS-20

# WALTON EAST

Chair and Stool



103



103-BS-30

One of our original series, enhanced and expanded. Walton captures solid, premium wood construction and a variety of specification options. Walton East offers rail-back design and Walton West a ladder-back design with contemporary styling.



Swivel base

Chair with Arms and Tablet



104



103-RTA

## DIMENSIONS

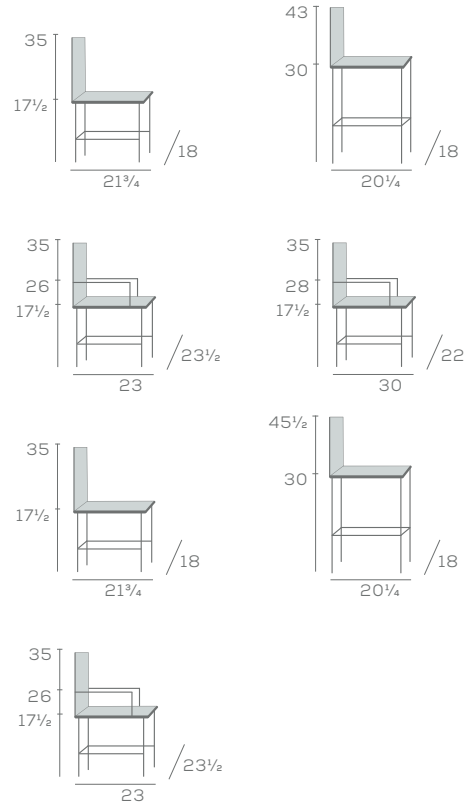

# WALTON EAST

Chair and Stool with Clean Through Backrest



107US



107US-BS-30

Available in Maple and Oak Wood

Key Features

- Rail-back Backrest
- Clean Through Design
- Saddle and Upholstered Seat
- Replaceable Seats
- Side Brace for Beauty and Support
- Bookshelf Stretcher
- Steam Bent Parts
- Solid Wood Corner Blocks

Available Options

- Upholstered seat pad with nail trim, specify in Brass 'BNT', Antique 'ANT', Stainless 'SNT', or Oxford 'ONT'
- Fully extended or clean through backrest
- Wood or upholstered seat
- Jury base on chair models
- Straight, moderate arc, and elevated arc top rails
- Decorative cutout, specify 'C'
- Side brace
- Motion seat on stools, specify '102' models
- 24" stool height, specify '24'
- Brass channel standard, or specify in Stainless 'SSC'

Chair with Arms and Clean Through Backrest



105US



straight top      arc top rail      arc top rail



cutout      side brace      motion seat



Walton Benches, page 99

Walton West continues >

# WALTON WEST

Chair and Stool with 5-Slat Backrest



53-18



53US-BS-30

One of our original series, enhanced and expanded. Walton captures solid, premium wood construction and a variety of specification options. Walton East offers rail-back design and Walton West a ladder-back design with contemporary styling.

## DIMENSIONS

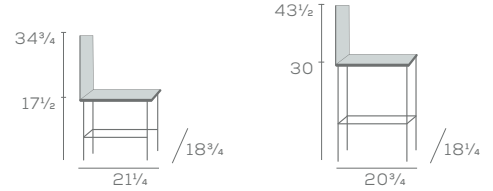
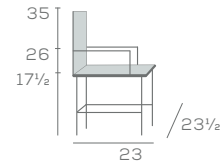
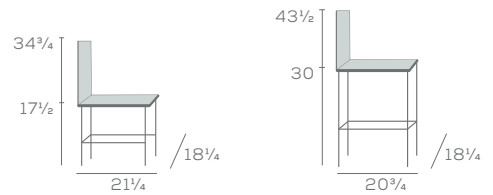

Chair with Arms



51

80

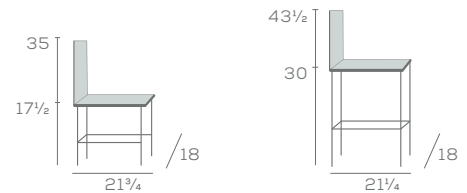

WALTON  
WEST

Chair and Stool with 2-Slat Backrest



57US-18



57US-BS-30

Available in Maple and Oak Wood

Key Features

- Ladder-back Backrest
- Clean Through Design
- Saddle and Upholstered Seat
- Replaceable Seats
- Bookshelf Stretcher
- Steam Bent Parts
- Solid Wood Corner Blocks

Available Options

- Upholstered seat pad with nail trim, specify in Brass 'BNT', Antique 'ANT', Stainless 'SNT', or Oxford 'ONT'
- Wood or upholstered seats and backrests
- Decorative cutout, specify 'C'
- Seat and frame in multi-finish
- Front leg casters on chairs, specify 'CA'
- 24" stool height, specify 'CTR'
- Brass channel standard, or specify in Stainless 'SSC'



cutout

Chair and Stool with Upholstery



507UBS



507UBS-BS-30

# WARREN

Bench



118US

**Mix Warren with your choice of chairs. The round seat and ladder base coordinate with a wide variety of styles. Wood seats allow personalization or the option to contrast finish colors.**

Available in Maple and Oak Wood

#### Key Features

- Contoured Round Seat
- Clean Aesthetic
- Multifaceted Stretcher
- Three Heights
- Exposed Solid Wood Frame
- Solid Wood Corner Blocks

#### Available Options

- Wood or upholstered seat
- Seat and frame in multi-finish
- Motion seat on all models, specify 'MO'
- Personalized laser engraved seat
- Personalized stamped seat

Stools



124



130US

#### DIMENSIONS

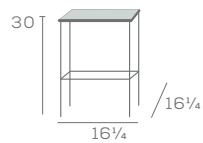
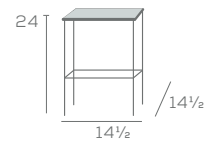
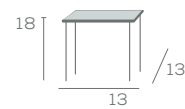



# WYLIE

Bench and Stool



S-9556-18



S-9556-30

**Blend Wylie in any environment with ease. Featuring a round stretcher ring, tapered legs, and the ability to personalize the shaped seat.**

Available in Maple and Oak Wood

**Key Features**

- Square Seat with Angle & Radius Edges
- Clean Aesthetic
- Tapered Legs
- Metal Ring Stretcher
- Exposed Solid Wood Frame
- Interlocking Solid Wood Corner Blocks
- Flex-O-Lator Spring Seats

**Available Options**

- Wood or upholstered seat
- 24" stool height, specify '24'
- Seat and frame in multi-finish
- Personalized laser engraved seat
- Personalized stamped seat
- Chrome ring standard, or specify in Stainless 'SSR' or Black 'BLR'

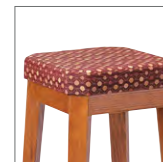

uph. seat

DIMENSIONS

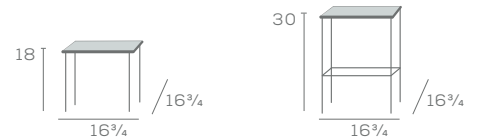



# LOUNGE & BENCHES

# ARNOLD

Single Seat



300-1

Clean lines and crisp tailoring make Arnold an attractive option for any location. Full upholstery is contrasted with wood arm caps for a distinct look and longevity.

Available in Maple and Oak Wood

#### Key Features

- Wood Cap Arms
- Replaceable Seat, Backrest & Arms
- Replaceable Upholstery Covers
- Flex-O-Lator Spring Seats

#### Available Options

- Dual upholstery on cushions and frame



Three Seat, model 300-3

Two Seat



300-2

#### DIMENSIONS

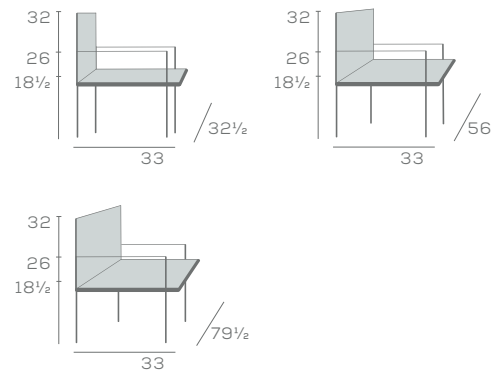



# BEREA

Single Seat



310-1

Simple forms with plush arms, soft radiuses, and wood legs highlight an abundance of character in Berea.

Available in Maple Wood

Key Features

- Wood Legs
- Replaceable Seat, Backrest & Arms
- Replaceable Upholstery Covers
- Flex-O-Lator Spring Seats

Available Options

- Dual upholstery on cushions and frame



Three Seat, model 310-3

Two Seat



310-2

DIMENSIONS

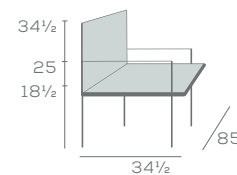
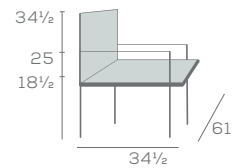
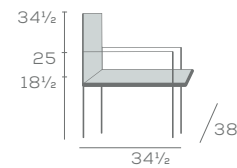

# CLIVE

Single Seat with Rectilinear Backrest and Open Arms



5710-1

With classic form, Clive features soft corners, open arms, and a studious presentation. Choose from four unique arm options.



Ovoid Backrest

## DIMENSIONS

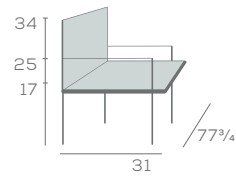
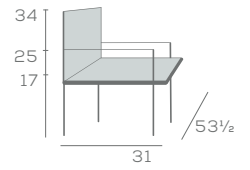
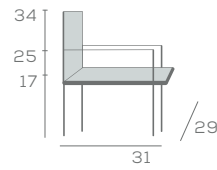

Two Seat with Rectilinear Backrest and Open Arms



5710-2

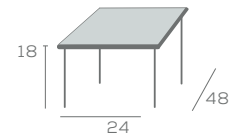
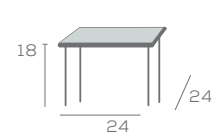



CLIVE

One and Two Seat Bench



2424US-18-WS



2448US-18

Available in Maple and Oak Wood

Key Features

- Rectilinear or Ovoid Backrest
- Rectilinear Models include Extra Seat Width
- Steambent Wood Arms with Gentle Radius

Available Options

- Dual upholstery on seat and backrest
- Open, wood slats, wood or upholstered arms



rect. backrest



ovoid backrest



open arm



slat arm



panel arm



uph. arm

Three Seat Bench with Rectilinear Backrest and Slat Sides



5710-3-WS



Clive Chairs, page 24  
Clive Tables, page 102

# EDINA

Single Seat with Upholstered Arm Pads



470-1-UA

**Edina displays a mission design aesthetic with a multitude of options and superior wood construction. The two and three seat models are available as tandem.**



Tandem two seat, model 470-2-A

## DIMENSIONS

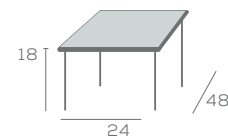
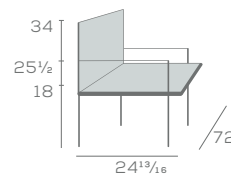
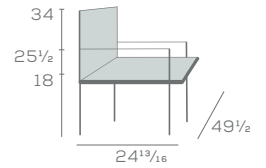
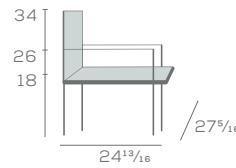

Two Seat



470-2

# EDINA

Two Seat Bench



470-B-2448US-18

Available in Maple and Oak Wood

Key Features

- Intricately Routed Arms
- Clean Through Design
- Replaceable Seat & Backrest
- Flex-O-Lator Spring Seats

Available Options

- Dual upholstery on seat and backrest
- Two & three seat tandem models
- Upholstered armpad, specify 'UA'

Three Seat Tandem



470-3-A



[Edina Chairs, page 32](#)

[Edina Tables, page 102](#)

# LENEXA

Single Seats with Open and Upholstered Arms



360-1

360-1-HB

Lenexa was designed with gentle curves, soft upholstery, radius edges, and steel support system for ultimate durability and comfort.



Single seats with linking tables

## DIMENSIONS

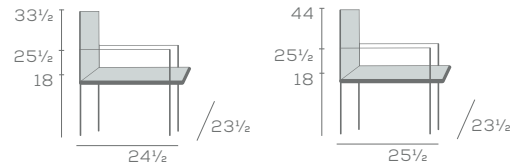

Two Seat

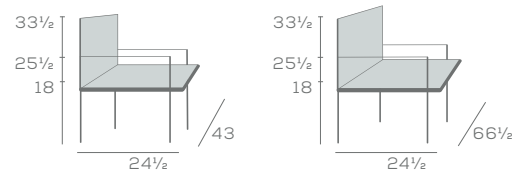

360-2

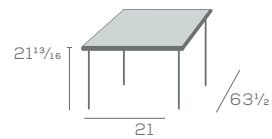

# LENEXA

Three Seat Bench



360-3-B

Available in Maple and Oak Wood

Key Features

- Arched Backrest
- Radius Edges
- Clean Through Design
- Tandem Arms & Linking Tables
- Replaceable Seat and Backrest
- Steel Support System
- Flex-O-Lator Spring Seats

Available Options

- Upholstered arm panel, specify 'UA'
- Two & three seat tandem models
- Linking tables



open arm



uph. arm



linking tables

Three Seat Tandem



360-3-A

# MACY

Single Seat



953-L-DSL

**A clean, modern look with tailored cushions and the option to personalize with stitching. Macy coexists in spaces with a warm, relaxed sense of familiarity.**

Available in Maple Wood

Key Features

- Plush Tapered Backrest
- Tapered Legs
- Solid Wood Corner Blocks
- Flex-O-Lator Spring Seats

Available Options

- Decorative stitching, specify Grid 'DSG' or Line 'DSL'

---

DIMENSIONS

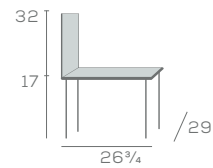

Ottomans



R-623-18



R-623-36



Macy Chairs, page 48

# OAKLEY

Single Seat and Two Seat Bench



320-1

320-2448US-18

Oakley presents an abundance of charm with intricately routed and rolled arms, deep foam seats, and arched backrest. The beautifully shaped wood frame adds a touch of warmth for any space.

Available in Maple and Oak Wood

Key Features

- Arched Backrest
- Intricately Routed Arms
- Deep Foam Seats
- Solid Wood Corner Blocks
- Flex-O-Lator Spring Seats

Available Options

- Dual upholstery on seat and backrest

Three Seat



320-3

DIMENSIONS

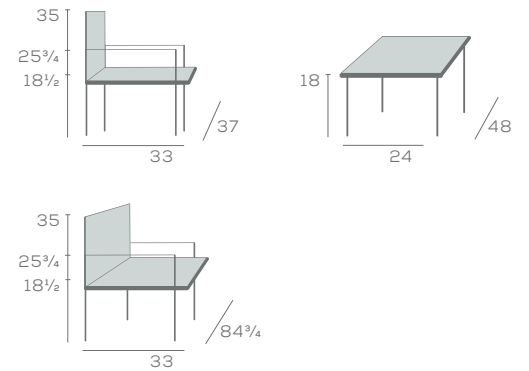

Oakley Tables, page 103



# TAYLOR EAST

Single Seat



174-1

Two Seat



174-2

The ever timeless Taylor features open arms with clean design aesthetic. All models available as sled or 4-leg base options. Select Taylor East with a heavier wood presence or Taylor West with a thinner wood structure.



Sled bases models

## DIMENSIONS

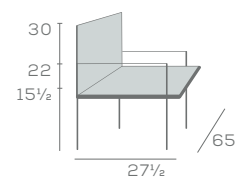
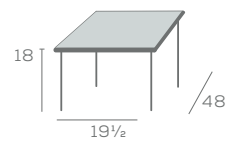
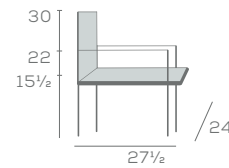
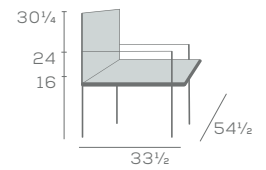
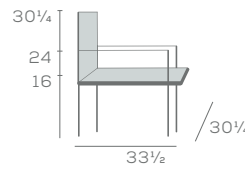

TAYLOR  
WEST

Single Seat and Two Seat Bench



84-1



86-SB

Available in Maple and Oak Wood

Key Features

- Two Wood Frame Styles
- Sled and 4-Leg Bases
- Replaceable Seats and Backrest
- Solid Wood Corner Blocks
- Flex-O-Lator Spring Seats

Available Options

- Dual upholstery on seat and backrest
- Sled and 4-leg bases
- Ganging hardware, West models, specify 'GGH'
- Upholstered arm panel, East models, specify 'P'



sled base



ganging

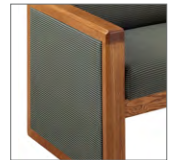

uph. arm

Three Seat



84-3



Taylor Chairs, page 70  
Taylor Tables, page 103

# TIFFIN

Single Seat



11-96-1

The ever popular Tiffin features a bullnose edge detail and open arms with clean design aesthetic. All models available as sled or 4-leg bases.

Available in Maple and Oak Wood

#### Key Features

- Exposed Wood Frame
- Sled and 4-Leg Bases
- Replaceable Seats and Backrest
- Solid Wood Corner Blocks
- Flex-O-Lator Spring Seats

#### Available Options

- Dual upholstery on seat and backrest
- Ganging hardware, specify 'GGH'
- Upholstered arm panel, specify 'P'



uph. arm



ganging

Three Seat



11-96-3

#### DIMENSIONS

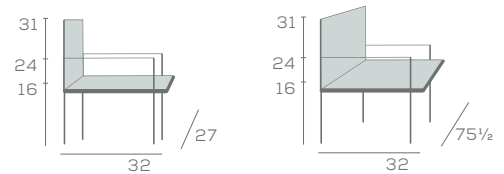

Tiffin Chairs, page 74

Tiffin Tables, page 103

# WALTON

Two Seat Bench



509US-2

Three Seat Bench



509US-3

One of our original series, enhanced and expanded. Walton captures solid, premium wood construction and a variety of specification options.

Available in Maple and Oak Wood

Key Features

- Rail-back Backrest
- Clean Through Design
- Replaceable Seat
- Steam Bent Parts
- Solid Wood Corner Blocks

Available Options

- Upholstered seat pad with nail trim, specify in Brass 'BNT', Antique 'ANT', Stainless 'SNT', or Oxford 'ONT'
- Wood or upholstered seat



nail trim



wood seat

DIMENSIONS

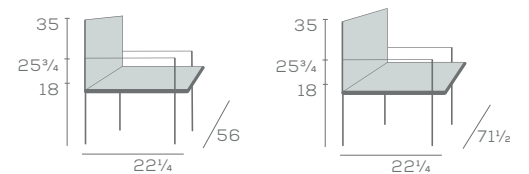

Walton Chairs, page 78





# TABLES

---

# OCCASIONAL

Square and Rectangle Tops with Clive Base

**With universal appeal, these four distinctly styled tables coordinate with lounge collections, or work effortlessly in most any furniture decor.**



L-5700-2424P18-E



L-5700-2448P18-E

---

## DIMENSIONS

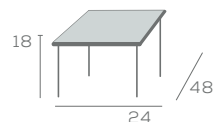
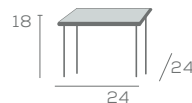

Square and Rectangle Tops with Edina Base



L-470-2424P18-E



L-470-2448P18-E



# OCCASIONAL

Square and Rectangle Tops with Oakley Base



L-320-2424P18-E



L-320-2448P18-E

Available in Maple and Oak Wood

Key Features

- Wood Base with Laminate Tops
- Solid Wood or Laminate Edge
- Solid Wood Apron
- Solid Wood Corner Blocks

Available Options

- Edges coordinate with laminate top or wood base
- Laminate tops in matching wood finish colors, or specify custom selection

Edges



self

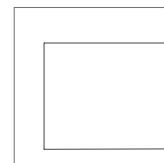

square

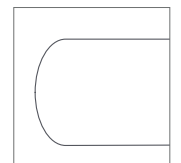

bullnose

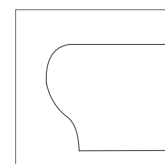

traditional

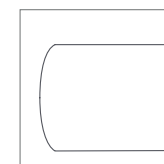

thumbnail

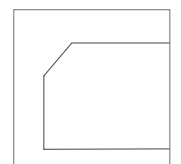

bevel

Square and Rectangle Tops with Taylor/Tiffin Base



L-80-2424P18-S



L-80-2448P18-E

# COLLABORATION

Round Top with Square Legs



L-42RP29-E-S

Tables designed with libraries in mind and a vast array of options. Select square or tapered legs, three top shapes, and variety of edge details.

## DIMENSIONS

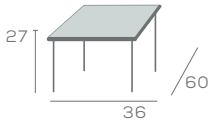
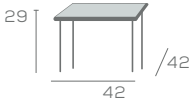
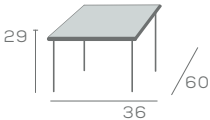
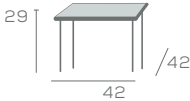

Rectangle Top with Tapered Legs



L-3660P29-E-T

# COLLABORATION

Square Top with Tapered Legs



L-4242P29-E-T

Rectangle Top for Juvenile



L-3660P27-E-T

Available in Maple and Oak Wood

Key Features

- Three Top Shapes in Multiple Sizes
- Wood Base with Laminate Tops
- Tapered or Square Leg Shape
- Solid Wood, PVC or Laminate Edge
- Interlocking Solid Wood Corner Blocks

Available Options

- Edge details in coordinating laminate top, coordinating wood base, or five pvc colors
- Wood legs with tapered or square legs
- Laminate tops in matching wood finish colors, or specify with custom selection

Edges

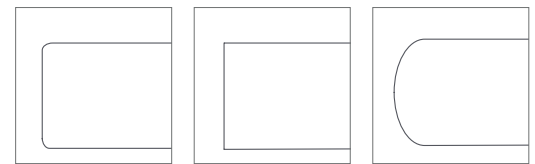

self and pvc

square

bullnose

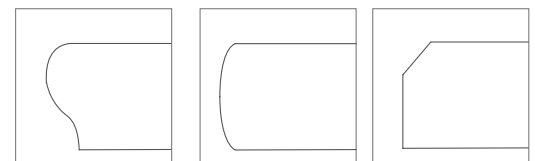

traditional

thumbnail

bevel

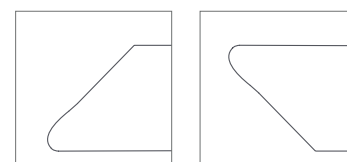

knife

reverse knife

# MULTI-FUNCTIONAL

Round Top with Crosswise Base



L-E-30R & MB-2222

Tables designed with hospitality in mind. Select from three top shapes in a variety of sizes, edge details and base options.

## DIMENSIONS

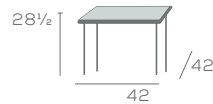
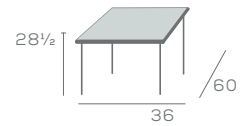
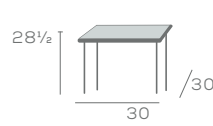

Rectangle Top with T Base



L-E-3660 & MB-522

# MULTI-FUNCTIONAL

Square Top with Crosswise Base



L-3P-4242 & MB3030

Available in Metal and Laminate

Key Features

- Three Top Shapes in Multiple Sizes
- Laminate Tops
- Solid Wood, PVC or Laminate Edge
- Leveling Glides for Adjustment
- Heavy Gauge Metal Base in Three Designs

Available Options

- Edge details in coordinating laminate top, coordinating wood base, or five pvc colors
- PVC edge colors Slate, Espresso, Taupe, Gray, and Beige
- Laminate tops in matching wood finish colors, or specify with custom selection
- Height standard for chairs, specify for bar height BH'

Edges



self and pvc

square

bullnose

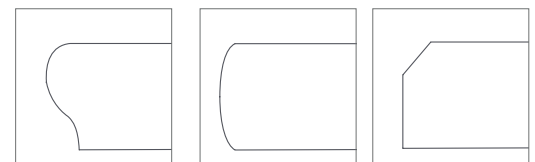

traditional

thumbnail

bevel

Bases



crosswise

round

t-base











# PRICING

# ADDI

Product information on page 12.

## PRICE

## SPECIFICATIONS

Model Number		All Wood	Fabric COM/200	Fabric Grade 300	Fabric Grade 400	Fabric Grade 500	Fabric Grade 600	Fabric Grade 700	Width	Depth	Height	Seat Depth	Seat Height	Arm Height	Weight (lbs.)	Fabric (yds.)
667			\$626	\$651	\$676	\$702	\$730	\$758	19.5	22	35.5	17	18		21	1.5
665			\$688	\$714	\$737	\$765	\$791	\$821	21.75	22	35.5	17	18	26.75	24	1.5
667-BS-24			\$660	\$685	\$709	\$736	\$764	\$792	19	20.25	40	16	24		25	1.5
667-BS-30			\$660	\$685	\$709	\$736	\$764	\$792	19	20.25	46	16	30		25	1.5
668-BS-30			\$756	\$782	\$806	\$833	\$860	\$889	17.5	21	45.5	16	30		34	1.5

Specify nail trim color: 'BNT' Brass (standard), 'ANT' Antique, 'SNT' Stainless, or 'ONT' Oxford. *No upcharge.*



Specify leather strap color: 'BL' Black, 'BU' Burgundy, 'BR' Brown, or 'TA' Tan. See page 180 for selections. *No Upcharge.*

Footrail channel on stool models standard in Brass. Specify in 'SSC' Stainless Steel. *No upcharge.*

Front leg casters available on chair models, specify 'CA'. *Add \$40 list per chair.*

# AFTON

Product information on page 13.

Model Number	PRICE							SPECIFICATIONS							
	All Wood	Fabric COM/200	Fabric Grade 300	Fabric Grade 400	Fabric Grade 500	Fabric Grade 600	Fabric Grade 700	Width	Depth	Height	Seat Depth	Seat Height	Arm Height	Weight (lbs.)	Fabric (yds.)
65-18 	\$175							16	12	18	12	18		18	
65-BS-24 	\$200							17	13	24	12	24		20	
65-BS-30	\$225							18	14	30	12	30		22	

Specify Maple or Oak wood.

Multi-finish on seat & frame. Add \$25 list per chair.

Personalized laser engraving on seats. Add \$100 set up charge and \$50 list per chair.



Personalized stamping on seats. Add \$100 set up charge and \$50 list per chair.

# ALLIS EAST

Product information on page 14.

## PRICE

## SPECIFICATIONS

Model Number	All Wood	Fabric COM/200	Fabric Grade 300	Fabric Grade 400	Fabric Grade 500	Fabric Grade 600	Fabric Grade 700	Width	Depth	Height	Seat Depth	Seat Height	Arm Height	Weight (lbs.)	Fabric (yds.)
677UBS 677UBS-NT		\$451 \$475	\$482 \$505	\$510 \$535	\$543 \$568	\$559 \$599	\$611 \$633	20 20	24.5 24.5	37.75 37.75	18 18	20 20		24 24	1.75 1.75
675UBS 675UBS-NT		\$496 \$519	\$525 \$550	\$555 \$578	\$588 \$611	\$621 \$644	\$655 \$678	23 23	24.5 24.5	37.75 37.75	18 18	20 20	26.5 26.5	27 27	1.75 1.75
677UBS-BS-24 677UBS-BS-30 677UBS-BS-24-NT 677UBS-BS-30-NT		\$500 \$500 \$526 \$526	\$530 \$530 \$568 \$568	\$558 \$558 \$604 \$604	\$574 \$574 \$644 \$644	\$624 \$624 \$685 \$685	\$658 \$658 \$728 \$728	19 19 19 19	21.75 21.75 21.75 21.75	40 46 40 46	17 17 17 17	25 31 25 31		27 27 27 27	1.75 1.75 1.75 1.75

Specify nail trim color for 'NT' models: 'BNT' Brass (standard), 'ANT' Antique, 'SNT' Stainless, or 'ONT' Oxford. *No upcharge.*

Footrail channel on stool models standard in Brass. Specify in 'SSC' Stainless Steel. *No upcharge.*

Front leg casters available on chair models, specify 'CA'. *Add \$40 list per chair.*

Handhold cutout, specify 'HH'. *Add \$10 list per chair.*



Piping and backrest in dual upholstery, specify materials. *No upcharge.*

# ALLIS WEST

Product information on page 15.

## PRICE

## SPECIFICATIONS

Model Number	PRICE							SPECIFICATIONS							
	All Wood	Fabric COM/200	Fabric Grade 300	Fabric Grade 400	Fabric Grade 500	Fabric Grade 600	Fabric Grade 700	Width	Depth	Height	Seat Depth	Seat Height	Arm Height	Weight (lbs.)	Fabric (yds.)
663UBS 683UBS-NT		\$421 \$446	\$457 \$481	\$492 \$512	\$531 \$551	\$572 \$588	\$613 \$627	19.5 19.5	22 22	35.5 35.5	17 17	18 18		21 21	1.75 1.125
661UBS 681UBS-NT		\$456 \$479	\$492 \$514	\$527 \$545	\$567 \$582	\$607 \$620	\$648 \$659	21.75 21.75	22 22	35.5 35.5	17 17	18 18	26.75 26.75	24 24	1.75 1.125
663UBS-BS-24 663UBS-BS-30 683UBS-BS-24-NT 683UBS-BS-30-NT		\$469 \$469 \$494 \$494	\$505 \$505 \$529 \$529	\$540 \$540 \$560 \$560	\$579 \$579 \$599 \$599	\$620 \$620 \$636 \$636	\$661 \$661 \$675 \$675	19 19 19 19	20.25 20.25 20.25 20.25	40 46 40 46	16 16 16 16	24 30 24 30		25 25 25 25	1.75 1.75 1.125 1.125

Specify nail trim color for 'NT' models: 'BNT' Brass (standard), 'ANT' Antique, 'SNT' Stainless, or 'ONT' Oxford. *No upcharge.*

Footrail channel on stool models standard in Brass. Specify in 'SSC' Stainless Steel. *No upcharge.*

Front leg casters available on chair models, specify 'CA'. *Add \$40 list per chair.*



Piping and backrest in dual upholstery, specify materials. *No upcharge.*

# ARNOLD

Product information on page 86.

## PRICE

## SPECIFICATIONS

Model Number	All Wood	Fabric COM/200	Fabric Grade 300	Fabric Grade 400	Fabric Grade 500	Fabric Grade 600	Fabric Grade 700	Width	Depth	Height	Seat Depth	Seat Height	Arm Height	Weight (lbs.)	Fabric (yds.)
300-1 		\$1713	\$1891	\$2060	\$2254	\$2446	\$2650	32.5	33	32	19.5	18.5	26	85	4.74
300-2 		\$2861	\$3169	\$3460	\$3793	\$4127	\$4478	56	33	32	19.5	18.5	26	119	8.125
300-3 		\$3335	\$3680	\$4006	\$4380	\$4752	\$5147	79.5	33	32	19.5	18.5	26	150	9.125

Cushions in dual upholstery, specify material. *No upcharge.*



# ASHER





Product information on page 16.

Model Number	PRICE							SPECIFICATIONS							
	All Wood	Fabric COM/200	Fabric Grade 300	Fabric Grade 400	Fabric Grade 500	Fabric Grade 600	Fabric Grade 700	Width	Depth	Height	Seat Depth	Seat Height	Arm Height	Weight (lbs.)	Fabric (yds.)
8663UBS-18 		\$450	\$475	\$500	\$525	\$550	\$585	18.5	20	32.5	18	18		21	1
8667UBS-ST 		\$490	\$515	\$540	\$565	\$590	\$625	18.5	20	32.5	18	18		23	1
8663UBS-BS-24 		\$512	\$537	\$563	\$582	\$612	\$647	18.5	20	38	18	24		29	1
8663UBS-BS-30		\$512	\$537	\$563	\$582	\$612	\$647	18.5	20	44	18	30		29	1

Footrail channel on stool models standard in Brass. Specify in 'SSC' Stainless Steel. *No upcharge.*  
 Decorative buttons, specify 'DB'. *Add \$10 list per chair.*

# BECKET

Product information on page 17.

Model Number		PRICE						SPECIFICATIONS								
		All Wood	Fabric COM/200	Fabric Grade 300	Fabric Grade 400	Fabric Grade 500	Fabric Grade 600	Fabric Grade 700	Width	Depth	Height	Seat Depth	Seat Height	Arm Height	Weight (lbs.)	Fabric (yds.)
9838US			\$337	\$358	\$390	\$405	\$433	\$460	19	20	34.5	17	18		21	1
9838US-BS-24			\$384	\$405	\$427	\$452	\$480	\$507	19	19	35	17	24		24	1
9838US-BS-30			\$384	\$405	\$427	\$452	\$480	\$507	19	19	41	17	30		24	1
9833US			\$337	\$358	\$390	\$405	\$433	\$460	19	20	34.5	17	18		21	1
9833US-BS-24			\$384	\$405	\$427	\$452	\$480	\$507	19	19	35	17	24		24	1
9833US-BS-30			\$384	\$405	\$427	\$452	\$480	\$507	19	19	41	17	30		24	1

Specify Maple or Oak wood.

Footrail channel on stool models standard in Brass. Specify in 'SSC' Stainless Steel. *No upcharge.*

Decorative stitching on 9838US and 9838US-BS-30 models, specify 'DSS'. *No upcharge.*

# BEREA

Product information on page 87.

Model Number	PRICE							SPECIFICATIONS							
	All Wood	Fabric COM/200	Fabric Grade 300	Fabric Grade 400	Fabric Grade 500	Fabric Grade 600	Fabric Grade 700	Width	Depth	Height	Seat Depth	Seat Height	Arm Height	Weight (lbs.)	Fabric (yds.)
310-1 		\$1558	\$1764	\$1958	\$2182	\$2404	\$2639	38	34.5	34.5	20	18.5	25	85	5.5
310-2 		\$2646	\$2916	\$3172	\$3466	\$3758	\$4067	61	34.5	34.5	20	18.5	25	119	7.125
310-3 		\$3175	\$3541	\$3887	\$4284	\$4680	\$5097	85	34.5	34.5	20	18.5	25	150	9.625





Cushions in dual upholstery, specify material. *No upcharge.*

# BEXLEY

Product information on page 18.

## PRICE

## SPECIFICATIONS

Model Number	All Wood	Fabric COM/200	Fabric Grade 300	Fabric Grade 400	Fabric Grade 500	Fabric Grade 600	Fabric Grade 700	Width	Depth	Height	Seat Depth	Seat Height	Arm Height	Weight (lbs.)	Fabric (yds.)
233 233US		\$275	\$302	\$313	\$323	\$337	\$349	\$363	18	21.5	35	14.75	17.5	22	
233-US-24 233-US-30		\$354							18	20	36	14.75	24	29	
233US-US-24 233US-US-30		\$354	\$374	\$386	\$397	\$410	\$422	\$436	18	20	36	14.75	24	29	.625
232-US-24 232-US-30		\$485							18	20	36	14.75	24	37	
232US-US-24 232US-US-30		\$485	\$505	\$518	\$528	\$541	\$554	\$568	18	20	36	14.75	24	37	.625
			\$505	\$518	\$528	\$541	\$554	\$568	18	20	43	14.75	30	37	.625

Specify Maple or Oak wood.

Footrail channel on stool models standard in Brass. Specify in 'SSC' Stainless Steel. *No upcharge.*

Nail trim with upholstered seat pad on 'US' models, specify 'BNT' Brass, 'ANT' Antique, 'SNT' Stainless, or 'ONT' Oxford. *Add \$20 list per chair; reduce fabric to .5 yds.*

Front leg casters available on chair models, specify 'CA'. *Add \$40 list per chair.*

# BROOKS

Product information on page 19.

Model Number	PRICE							SPECIFICATIONS							
	All Wood	Fabric COM/200	Fabric Grade 300	Fabric Grade 400	Fabric Grade 500	Fabric Grade 600	Fabric Grade 700	Width	Depth	Height	Seat Depth	Seat Height	Arm Height	Weight (lbs.)	Fabric (yds.)
923 		\$525	\$577	\$628	\$680	\$747	\$814	19	22	32	18	20		55	1.5
923-BS-30 		\$577	\$628	\$680	\$731	\$798	\$865	19	22	39.5	18	30.5		65	1.5
S-925-BS-30 		\$417	\$437	\$456	\$476	\$496	\$517	19	19	30.5	16	30.5		25	1.5

Footrail ring on stool models standard in Brass. Specify in 'SSR' Stainless Steel or 'BLR'. *No upcharge.*

Nail trim available, specify 'BNT' Brass, 'ANT' Antique, 'SNT' Stainless, or 'ONT' Oxford. *Add \$30 list per chair for back, \$50 list per chair for seat, and \$80 list per chair for seat and backrest.*

Motion seats available on all models, specify 'MO'. *Add \$42 list per chair.*

Decorative stitching, specify 'DS'. *No upcharge.*





Backrest in dual upholstery, specify material. *No upcharge.*

# CHELSEY

Product information on page 20.

## PRICE

## SPECIFICATIONS





Model Number	All Wood	Fabric COM/200	Fabric Grade 300	Fabric Grade 400	Fabric Grade 500	Fabric Grade 600	Fabric Grade 700	Width	Depth	Height	Seat Depth	Seat Height	Arm Height	Weight (lbs.)	Fabric (yds.)
8803 8803US-18 8803UBS-18	\$557														
		\$575	\$591	\$607	\$624	\$641	\$660	20.5	23	35	17.5	18		25	.625
		\$652	\$684	\$714	\$748	\$782	\$817	20.5	23	35	17.5	18		25	1.125
8801 8801US 8801UBS	\$620														
		\$639	\$655	\$670	\$686	\$705	\$722	22.5	23	35	17.5	18	26	27	.625
		\$718	\$749	\$779	\$813	\$847	\$883	22.5	23	35	17.5	18	26	27	1.125
8803US-18-ST 8803UBS-18-ST															
	\$595	\$611	\$627	\$644	\$661	\$680	20.5	23	35	17.5	18		25	.625	
	\$664	\$680	\$695	\$713	\$730	\$748	20.5	23	35	17.5	18		25	1.125	
8801US-ST 8801UBS-ST															
	\$660	\$676	\$691	\$708	\$726	\$744	22.5	23	35	17.5	18	26	27	.625	
	\$740	\$770	\$800	\$834	\$868	\$904	22.5	23	35	17.5	18	26	27	1.125	
8803US-BS-30 8803UBS-BS-30															
	\$670	\$701	\$731	\$756	\$799	\$834	18.75	20.5	45.75	16	30		28	.625	
	\$745	\$794	\$838	\$880	\$940	\$994	18.75	20.5	45.75	16	30		28	1.125	

Footrail channel on stool models standard in Brass. Specify in 'SSC' Stainless Steel. *No upcharge.*  
Ganging hardware available, specify 'GGH'. *Add \$28 list per chair.*



CLAY

Product information on page 22.

Model Number	PRICE							SPECIFICATIONS								
	All Wood	Fabric COM/200	Fabric Grade 300	Fabric Grade 400	Fabric Grade 500	Fabric Grade 600	Fabric Grade 700	Width	Depth	Height	Seat Depth	Seat Height	Arm Height	Weight (lbs.)	Fabric (yds.)	
511 511-NT		\$484	\$534	\$541	\$551	\$560	\$569	\$576	24.25 24.25	19.75 19.75	28.5 28.5	15 15	18 18	28 28	30 30	.625
511-BS-30 511-BS-30-NT		\$554	\$604	\$611	\$621	\$630	\$639	\$646	23.25 23.25	18.75 18.75	41.25 41.25	15 15	30 30	39.5 39.5	30 30	.625
512-BS-30 512-BS-30-NT		\$582	\$631	\$641	\$649	\$658	\$667	\$674	23.25 23.25	19.25 19.25	41.25 41.25	15 15	30 30	39.5 39.5	38 38	.625
S-513-BS-30		\$364							16 16	16 16	30 30		30 30	20 20	20 20	.625

Specify nail trim color for 'NT' models: 'BNT' Brass (Standard), 'ANT' Antique, 'SNT' Stainless, or 'ONT' Oxford. *No upcharge.*





Footrail ring on stool models standard in Brass. Specify in 'SSR' Stainless Steel. *No upcharge.*

Front leg casters available on chair models, specify 'CA'. *Add \$40 list per chair.*

Motion seat available, specify '512' models.

# CLIVE

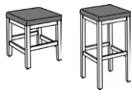
Product information on page 24 and 25.

Model Number	PRICE							SPECIFICATIONS							
	All Wood	Fabric COM/200	Fabric Grade 300	Fabric Grade 400	Fabric Grade 500	Fabric Grade 600	Fabric Grade 700	Width	Depth	Height	Seat Depth	Seat Height	Arm Height	Weight (lbs.)	Fabric (yds.)
2003-18 2003US-18		\$558						18.5	22.5	33	15	18		26	
		\$600	\$616	\$631	\$648	\$667	\$684	18.5	22.5	33	15	18		26	.875
2005 2005US		\$716						20.5	23.25	33	16	18	26	32	
		\$810	\$828	\$846	\$865	\$885	\$906	20.5	23.25	33	16	18	26	32	1
S-2003US-18 S-2003US-30		\$328	\$344	\$358	\$377	\$393	\$412	16.5	16.5	18				15	.75
		\$396	\$412	\$426	\$444	\$461	\$480	16.5	16.5	30				18	.75
2003-14 2003-16 2003US-14 2003US-16		\$558						14	17.5	26	12	14		20	
		\$558						14	17.5	28	12	16		20	
		\$600	\$616	\$631	\$648	\$667	\$684	14	17.5	26	12	14		20	.75
		\$600	\$616	\$631	\$648	\$667	\$684	14	17.5	28	12	16		20	.75

Specify Maple or Oak wood.

Front leg casters available on chair models, specify 'CA'. Add \$40 list per chair.

Ganging hardware available, specify 'GGH'. Add \$28 list per chair.

# CLIVE

Product information on page 102.

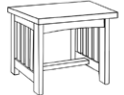
Model Number	PRICE							SPECIFICATIONS							
	All Edges							Width	Depth	Height	Seat Depth	Seat Height	Arm Height	Weight (lbs.)	Fabric (yds.)
L-5700-2424P-18 L-5700-2448P-18 L-5700-3232P-18		\$599						24	24	18				48	
		\$787						48	24	18				61	
		\$764						32	32	18				71	
L-5700-2424P-18-WS L-5700-2448P-18-WS L-5700-3232P-18-WS		\$658						24	24	18				50	
		\$846						48	24	18				63	
		\$823						32	32	18				73	

Specify Maple or Oak wood.

Specify edge: 'A' Square, 'B' Bullnose, 'C' Traditional, 'D' Thumbnail, 'E' Bevel.





Specify standard laminate top. See page 178 for selections. No upcharge.

Select COM laminate top. Add \$125 list per table.

Minimum order quantity. Add \$80 list per table for less than three tables per order.

PRICE

SPECIFICATIONS

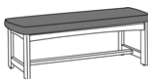
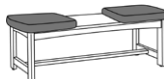
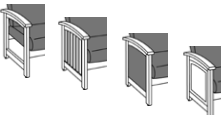
Model Number		PRICE						SPECIFICATIONS								
		All Wood	Fabric COM/200	Fabric Grade 300	Fabric Grade 400	Fabric Grade 500	Fabric Grade 600	Fabric Grade 700	Width	Depth	Height	Seat Depth	Seat Height	Arm Height	Weight (lbs.)	Fabric (yds.)
5760-1			\$962	\$1022	\$1076	\$1141	\$1205	\$1273	26	31	34	22	17	25	51	1.625
5760-1-WS			\$1067	\$1127	\$1182	\$1246	\$1311	\$1378	26	31	34	22	17	25	60	1.625
5760-1-P			\$1245	\$1361	\$1471	\$1597	\$1722	\$1853	26	31	34	22	17	25	70	3.25
5760-1-WP			\$1200	\$1260	\$1315	\$1379	\$1444	\$1511	26	31	34	22	17	25	68	1.625
5760-2			\$1491	\$1610	\$1721	\$1849	\$1977	\$2112	47.5	31	34	22	17	25	81	3.25
5760-2-WS			\$1600	\$1718	\$1829	\$1957	\$2085	\$2220	47.5	31	34	22	17	25	89	3.25
5760-2-P			\$1771	\$1938	\$2097	\$2277	\$2460	\$2650	47.5	31	34	22	17	25	113	4.5
5760-2-WP			\$1730	\$1848	\$1959	\$2087	\$2216	\$2349	47.5	31	34	22	17	25	108	3.25
5760-3			\$2154	\$2330	\$2498	\$2687	\$2881	\$3082	68.75	31	34	22	17	25	108	4.875
5760-3-WS			\$2261	\$2438	\$2605	\$2796	\$2987	\$3189	68.75	31	34	22	17	25	119	4.875
5760-3-P			\$2465	\$2706	\$2942	\$3213	\$3484	\$3770	68.75	31	34	22	17	25	143	6.625
5760-3-WP			\$2395	\$2572	\$2739	\$2931	\$3122	\$3324	68.75	31	34	22	17	25	138	4.875
5710-1			\$1040	\$1105	\$1168	\$1239	\$1310	\$1385	29	31	34	22	17	25	61	2.25
5710-1-WS			\$1146	\$1212	\$1275	\$1346	\$1417	\$1491	29	31	34	22	17	25	70	2.25
5710-1-P			\$1368	\$1500	\$1624	\$1766	\$1910	\$2059	29	31	34	22	17	25	80	3.5
5710-1-WP			\$1270	\$1336	\$1398	\$1469	\$1540	\$1615	29	31	34	22	17	25	78	2.25
5710-2			\$1637	\$1769	\$1891	\$2037	\$2176	\$2325	53.5	31	34	22	17	25	96	4.5
5710-2-WS			\$1757	\$1887	\$2012	\$2153	\$2295	\$2444	53.5	31	34	22	17	25	109	4.5
5710-2-P			\$1984	\$2169	\$2343	\$2544	\$2745	\$2955	53.5	31	34	22	17	25	130	4.875
5710-2-WP			\$1879	\$2011	\$2133	\$2275	\$2417	\$2567	53.5	31	34	22	17	25	125	4.5
5710-3			\$2387	\$2583	\$2769	\$2981	\$3194	\$3418	77.75	31	34	22	17	25	128	6.75
5710-3-WS			\$2494	\$2687	\$2874	\$3087	\$3299	\$3524	77.75	31	34	22	17	25	136	6.75
5710-3-P			\$2761	\$3033	\$3287	\$3581	\$3876	\$4183	77.75	31	34	22	17	25	168	7.125
5710-3-WP			\$2616	\$2813	\$2997	\$3211	\$3424	\$3555	77.75	31	34	22	17	25	163	6.75
2424US-18			\$501	\$523	\$543	\$567	\$591	\$615	24	24	18				42	.75
2424US-18-WS			\$561	\$582	\$603	\$627	\$650	\$675	24	24	18				45	.75
2448US-18			\$667	\$703	\$740	\$781	\$821	\$864	48	24	18				51	1.375
2448US-18-WS			\$727	\$764	\$800	\$842	\$882	\$925	48	24	18				53	1.375
2460US-18			\$736	\$784	\$829	\$882	\$933	\$989	60	24	18				62	1.75
2460US-18-WS			\$811	\$858	\$904	\$956	\$1008	\$1063	60	24	18				64	1.75
2460UWU-18			\$813	\$852	\$890	\$932	\$976	\$1021	60	24	18				58	1.375
2460UWU-18-WS			\$886	\$925	\$963	\$1005	\$1050	\$1094	60	24	18				58	1.375
-1, -2, -3 -WS -P -WP																

Specify Maple or Oak wood.















Seat and backrest in dual upholstery, specify material. No upcharge.

# DAKOTA

Product information on page 26.

## PRICE

## SPECIFICATIONS

Model Number	All Wood	Fabric COM/200	Fabric Grade 300	Fabric Grade 400	Fabric Grade 500	Fabric Grade 600	Fabric Grade 700	Width	Depth	Height	Seat Depth	Seat Height	Arm Height	Weight (lbs.)	Fabric (yds.)
609 		\$465	\$497	\$527	\$561	\$596	\$632	17.75	22.5	32.5	17	19			1.875
609-BS-24 		\$559	\$591	\$621	\$656	\$690	\$726	17.75	22.5	37.5	17	25.5			1.875
609-BS-30 		\$559	\$591	\$621	\$656	\$690	\$726	17.75	22.5	43.5	17	31.5			1.875
603 		\$472	\$505	\$536	\$571	\$607	\$644	17.75	22.5	32.5	17	19		20	1.875
603-BS-24 		\$569	\$602	\$632	\$668	\$703	\$741	17.75	22.5	37.5	17	24		28	1.875
603-BS-30 		\$569	\$602	\$632	\$668	\$703	\$741	17.75	22.5	43.5	17	30		28	1.875
602-BS-30 		\$622	\$654	\$684	\$719	\$753	\$789	17.75	22	45	17	32		40	1.875
607 		\$438	\$470	\$500	\$534	\$579	\$605	17.75	22.5	36	17	19		22	1.875
607-BS-24 		\$532	\$564	\$594	\$629	\$663	\$699	17.75	22.25	38.5	17	25.5		27	1.875
607-BS-30 		\$532	\$564	\$594	\$629	\$663	\$699	17.75	22.25	44.5	17	31.5		27	1.875
605 		\$428	\$460	\$490	\$524	\$566	\$591	18.5	22.75	34	17	19		22	1.625
605-BS-24 		\$490	\$522	\$552	\$586	\$628	\$653	18.5	22.25	38.5	17	25.5		27	1.625
605-BS-30 		\$490	\$522	\$552	\$586	\$628	\$653	18.5	22.25	44.5	17	31.5		27	1.625
633 		\$449	\$464	\$479	\$494	\$511	\$528	19	19	30				31	1.625
633-MO 		\$491	\$506	\$521	\$536	\$553	\$570	19	19	30				31	1.625

Specify Maple or Oak wood.

Footrail channel and foot ring on stool models standard in Brass. Specify in 'SSC' Stainless Steel. *No upcharge.*

Nail trim available on '603', '607', '605', and '633' models, specify 'BNT' Brass, 'ANT' Antique, 'SNT' Stainless, or 'ONT' Oxford. *Add \$30 list per chair for back, \$50 list per chair for seat, and \$80 list per chair for seat and backrest.*



Front leg casters available on chair models, specify 'CA'. *Add \$40 list per chair.*

Piping available in dual upholstery, specify material. *No upcharge.*

Motion seat available, specify 'MO' when ordering.

# DECKER

Product information on page 27.

Model Number	PRICE							SPECIFICATIONS							
	All Wood	Fabric COM/200	Fabric Grade 300	Fabric Grade 400	Fabric Grade 500	Fabric Grade 600	Fabric Grade 700	Width	Depth	Height	Seat Depth	Seat Height	Arm Height	Weight (lbs.)	Fabric (yds.)
453 453US 	\$266	\$296	\$310	\$322	\$338	\$351	\$367	19 19	20.5 20.5	35.5 35.5	17.5 17.5	18 18		24 24	1.875
453-BS-30 453US-BS-30 	\$323	\$355	\$368	\$381	\$396	\$410	\$425	19 19	21 21	45.5 45.5	17.5 17.5	30 30		25 25	1.875

Footrail channel on stool models standard in Brass. Specify in 'SSC' Stainless Steel. *No upcharge.*

Multi-finish on seat and frame. *Add \$25 list per chair.*

Personalized laser engraving on backrests. *Add \$100 set up charge and \$50 list per chair.*

# DIEGO

Product information on page 28.

## PRICE

## SPECIFICATIONS

Model Number	All Wood	Fabric COM/200	Fabric Grade 300	Fabric Grade 400	Fabric Grade 500	Fabric Grade 600	Fabric Grade 700	Width	Depth	Height	Seat Depth	Seat Height	Arm Height	Weight (lbs.)	Fabric (yds.)
SB (sled base) LB (leg base) 7000-NC 7010-PC 7020-FC	\$322 \$322 \$322							19.125 20	21.5 20	33.5 33	16 16	18 17.5		19 19	
SB (sled base) LB (leg base) 7000-NC-BS-30 7010-PC-BS-30 7020-FC-BS-30	\$435 \$435 \$435							17.75 19.5	23 21	44 45	16 16	30 29.75		22 22	
SB (sled base) LB (leg base) 7200-NC 7210-PC 7220-FC	\$322 \$322 \$322							19.125 20	21.5 20	33.5 33	16 16	18 17.5		19 19	
SB (sled base) LB (leg base) 7200-LB-BS-30 7200-NC-BS-30 7210-PC-BS-30 7220-FC-BS-30	\$435 \$435 \$435							17.75 19.5	23 21 23/21	44 45 32.5	16 16 16	18 17.5		22 22 22	
SB (sled base) LB (leg base) 7500-NC 7510-PC 7520-FC	\$322 \$322 \$322							19.125 20	21.5 20	33.5 33	16 16	18 17.5		19 19	
SB (sled base) LB (leg base) 7500-NC-BS-30 7510-PC-BS-30 7520-FC-BS-30	\$435 \$435 \$435							17.75 19.5	23 21	44 45	16 16	18 17.5		22 22	
7200UBS 7200UBS-BS-30 US-PAD DOLLY	\$408 \$521 +\$83 \$742	\$420 \$533 +\$95	\$433 \$546 +\$108	\$448 \$561 +\$122	\$462 \$575 +\$136	\$478 \$591 +\$151								55	.75 .75 .75

Specify Beech or Maple Wood.

Specify base style and color, 'LBC' Leg in Chrome, 'SBC' Sled in Chrome, or 'SBB' Sled in Black. *No upcharge.*

Upholstered seat pad available on all models, specify 'US' when ordering. *Add upcharge indicated to any all wood model.*

Functional hook cutout available on all models, specify 'HK' when ordering. *Add \$10 list per chair.*

Personalized laser engraving. *Add \$100 set up charge and \$50 list per chair.*

Personalized cutout designs. *Add \$100 set up charge and \$50 list per chair.*

Custom metal frame color. *Add \$20 list per chair.*



DOLTON

Product information on page 30.

Model Number	PRICE							SPECIFICATIONS							
	All Wood	Fabric COM/200	Fabric Grade 300	Fabric Grade 400	Fabric Grade 500	Fabric Grade 600	Fabric Grade 700	Width	Depth	Height	Seat Depth	Seat Height	Arm Height	Weight (lbs.)	Fabric (yds.)
623 		\$467	\$508	\$547	\$592	\$637	\$684	18.5	22	33.75	17	18		21	2.125
623-BS-24 		\$510	\$552	\$590	\$634	\$680	\$727	18.5	22	38.5	17	24		28	2.125
623-BS-30 		\$510	\$552	\$590	\$634	\$680	\$727	18.5	22	44.5	17	30		28	2.125
621 		\$501	\$545	\$587	\$634	\$681	\$732	25.5	22.5	33.75	17	18	26	24	2.25
623-BS-24-A 		\$539	\$577	\$613	\$655	\$696	\$740	23.25	22	38.5	17	24	31.75	32	2.125
623-BS-30-A 		\$539	\$577	\$613	\$655	\$696	\$740	23.25	22	44.5	17	30	37.75	32	2.125
S-623-18 		\$346	\$377	\$406	\$440	\$474	\$510	18	18	18				30	2
S-623-24 		\$411	\$443	\$472	\$506	\$540	\$575	18.5	18.5	24				22	1
S-623-30 		\$411	\$443	\$472	\$506	\$540	\$575	18.5	18.5	30				22	1

Footrail channel on stool models standard in Brass. Specify in 'SSC' Stainless Steel. *No upcharge.*

Front leg casters available on chair models, specify 'CA'. *Add \$40 list per chair.*









Piping and/or backrest in dual upholstery, specify material. *No upcharge.*

# EDINA

Product information on page 32.

## PRICE

## SPECIFICATIONS

Model Number		All Wood	Fabric COM/200	Fabric Grade 300	Fabric Grade 400	Fabric Grade 500	Fabric Grade 600	Fabric Grade 700	Width	Depth	Height	Seat Depth	Seat Height	Arm Height	Weight (lbs.)	Fabric (yds.)
5663-18 5663US-18		\$405	\$472	\$486	\$500	\$516	\$531	\$547	18.25 18.25	22 22	38.5 38.5	17.5 17.5	18.25 18.25		25 22	.7
5661 5661US		\$450	\$518	\$533	\$546	\$561	\$577	\$594	23.25 23.25	22 22	38.5 38.5	17.5 17.5	18.25 18.25	26 26	28 28	.7
5663-16 5663US-16		\$405	\$472	\$486	\$500	\$516	\$531	\$547	14.5 14.5	16.5 16.5	31 31	16 16	16 16		19 19	.6
5663-14 5663US-14		\$405	\$472	\$486	\$500	\$516	\$531	\$547	14.5 14.5	16.5 16.5	29 29	16 16	14 14		19 19	.6
5653-18 5653US-18		\$411	\$478	\$492	\$505	\$521	\$537	\$554	18.25 18.25	22 22	38.5 38.5	17.5 17.5	18.25 18.25		25 25	.7
5651 5651US		\$456	\$523	\$538	\$552	\$568	\$584	\$599	23.25 23.25	22 22	38.5 38.5	17.5 17.5	18.25 18.25	26 26	28 28	.7
5653-16 5653US-16		\$411	\$478	\$492	\$505	\$521	\$537	\$554	14.5 14.5	16.5 16.5	31 31	13.25 13.25	16 16		19 17	.6
5653-14 5653US-14		\$411	\$478	\$492	\$505	\$521	\$537	\$554	14.5 14.5	16.5 16.5	29 29	16 16	14 14		19 17	.6

Specify Maple or Oak wood.

Decorative cutout available on 5653 models, specify '3S'. Add \$20 list per chair.

# EDINA

Product information on page 90.

Model Number	PRICE							SPECIFICATIONS							
	All Wood	Fabric COM/200	Fabric Grade 300	Fabric Grade 400	Fabric Grade 500	Fabric Grade 600	Fabric Grade 700	Width	Depth	Height	Seat Depth	Seat Height	Arm Height	Weight (lbs.)	Fabric (yds.)
470-1 470-1-UA		\$1233 \$1279	\$1280 \$1355	\$1325 \$1389	\$1377 \$1451	\$1429 \$1512	\$1483 \$1577	27.3 27.3	24.8 24.8	34 34	18.5 18.5	18 18	25.5 26	37 38.5	1.25 1.5
470-2 470-2-UA		\$2116 \$2162	\$2211 \$2266	\$2301 \$2365	\$2405 \$2479	\$2508 \$2591	\$2617 \$2711	49.5 49.5	24.8 24.8	34 34	18.5 18.5	18 18	25.5 26	54 55.5	2.5 3
470-3 470-3-UA		\$2927 \$2973	\$3071 \$3126	\$3206 \$3271	\$3362 \$3436	\$3516 \$3599	\$3681 \$3775	72 72	24.8 24.8	34 34	18.5 18.5	18 18	25.5 26	69 70.5	3.75 4.25
470-2-A 470-2-A-UA		\$2415 \$2470	\$2511 \$2593	\$2602 \$2697	\$2706 \$2814	\$2807 \$2930	\$2918 \$3057	50.8 50.8	24.8 24.8	34 34	18.5 18.5	18 18	25.5 26	59 60.5	2.5 3.25
470-3-A 470-3-A-UA		\$3552 \$3642	\$3697 \$3807	\$3832 \$3958	\$3987 \$4133	\$4142 \$4306	\$4305 \$4491	74.5 74.5	24.8 24.8	34 34	18.5 18.5	18 18	25.5 26	82 83.5	3.75 4.75
470-B-2424US-18 470-B-2448US-18		\$622 \$849	\$660 \$945	\$696 \$1034	\$737 \$1137	\$779 \$1241	\$813 \$1349	24 24	24 48	18 18				24 34	.75 1.5

Specify Maple or Oak wood.

# EDINA

Product information on page 102.

Model Number	PRICE							SPECIFICATIONS							
	All Edges							Width	Depth	Height	Seat Depth	Seat Height	Arm Height	Weight (lbs.)	Fabric (yds.)
L-470-2424-18-E L-470-2448-18-E		\$702 \$825						24 48	24 24	18 18				50 68	

Specify Maple or Oak wood.

Specify standard laminate top. See page 178 for selections. *No upcharge.*

Select COM laminate top. *Add \$125 list per table.*





Minimum order quantity. *Add \$80 list per table for quantities less than three per order.*

# ELLANOR

Product information on page 33.

## PRICE



## SPECIFICATIONS

Model Number	All Wood	Fabric COM/200	Fabric Grade 300	Fabric Grade 400	Fabric Grade 500	Fabric Grade 600	Fabric Grade 700	Width	Depth	Height	Seat Depth	Seat Height	Arm Height	Weight (lbs.)	Fabric (yds.)
5813 5813US 	\$300	\$322	\$338	\$350	\$366	\$381	\$397	16.5 16.5	22 22	40.75 40.75	16.25 16.25	18 18		22 22	.75
5833 5833US 	\$307	\$329	\$343	\$356	\$372	\$386	\$403	16.5 16.5	22 22	40.75 40.75	16.25 16.25	18 18		22 22	.75
5705 5705US 	\$358	\$408	\$419	\$431	\$443	\$457	\$472	18.5 18.5	22.25 22.25	41 41	17.5 17.5	18 18		29 29	.75
5706 5706US 	\$340	\$390	\$401	\$413	\$425	\$439	\$455	18.5 18.5	22.25 22.25	41 41	17.5 17.5	18 18		29 29	.75

Nail trim with upholstered seat pad on 'US' models, specify 'BNT' Brass, 'ANT' Antique, 'SNT' Stainless, or 'ONT' Oxford. Add \$20 list per chair; reduce fabric to .5 yds.

# HANA

Product information on page 35.

Model Number	PRICE							SPECIFICATIONS							
	All Wood	Fabric COM/200	Fabric Grade 300	Fabric Grade 400	Fabric Grade 500	Fabric Grade 600	Fabric Grade 700	Width	Depth	Height	Seat Depth	Seat Height	Arm Height	Weight (lbs.)	Fabric (yds.)
883 		\$450	\$489	\$528	\$568	\$618	\$668	20	22	34.5	17.5	19		20	1.5
883-BS-24 		\$496	\$536	\$575	\$614	\$664	\$715	20	23.5	35.75	17.5	24		30	1.5
883-BS-30		\$496	\$536	\$575	\$614	\$664	\$715	20	23.5	41.75	17.5	30		30	1.5



Footrail channel on stool models standard in Brass. Specify in 'SSC' Stainless Steel. *No upcharge.*  
 Backrest in dual upholstery, specify material. *No upcharge.*

# HAYS EAST

Product information on page 36.

## PRICE

## SPECIFICATIONS

Model Number	All Wood	Fabric COM/200	Fabric Grade 300	Fabric Grade 400	Fabric Grade 500	Fabric Grade 600	Fabric Grade 700	Width	Depth	Height	Seat Depth	Seat Height	Arm Height	Weight (lbs.)	Fabric (yds.)
713 		\$507	\$570	\$628	\$696	\$764	\$835	19.5	22.5	37	17	18		26	2.25
711 		\$544	\$607	\$665	\$733	\$801	\$872	23.25	22.5	37	17	18	25.5	29	2.25
713-BS-24 		\$553	\$615	\$675	\$742	\$810	\$882	19.5	22	39	17	24		32	2.25
713-BS-30		\$553	\$615	\$675	\$742	\$810	\$882	19.5	22	45	17	30		32	2.25

Footrail channel on stool models standard in Brass. Specify in 'SSC' Stainless Steel. *No upcharge.*  
 Backrest in dual upholstery, specify material. *No upcharge.*

# HAYS WEST

Product information on page 37.

Model Number	PRICE							SPECIFICATIONS							
	All Wood	Fabric COM/200	Fabric Grade 300	Fabric Grade 400	Fabric Grade 500	Fabric Grade 600	Fabric Grade 700	Width	Depth	Height	Seat Depth	Seat Height	Arm Height	Weight (lbs.)	Fabric (yds.)
703 		\$545	\$594	\$642	\$695	748	\$804	19.5	23.5	36.75	18	18		26	2
703-A 		\$582	\$631	\$679	\$732	\$780	\$841	23.25	23.5	36.75	18	18	25.5	29	2
703-BS-24 		\$609	\$658	\$703	\$757	\$811	\$867	19.5	22.5	38.75	18	24		32	2
703-BS-30		\$609	\$658	\$703	\$757	\$811	\$867	19.5	22.5	44.75	18	30		32	2

Footrail channel on stool models standard in Brass. Specify in 'SSC' Stainless Steel. *No upcharge.*  
 Backrest in dual upholstery, specify material. *No upcharge.*







# JOLIET

Product information on page 38.

## PRICE

## SPECIFICATIONS

Model Number	All Wood	Fabric COM/200	Fabric Grade 300	Fabric Grade 400	Fabric Grade 500	Fabric Grade 600	Fabric Grade 700	Width	Depth	Height	Seat Depth	Seat Height	Arm Height	Weight (lbs.)	Fabric (yds.)
9903 		\$475	\$505	\$538	\$571	\$606	\$641	18	20	31	18	19		23	1.5
9901 		\$605	\$650	\$694	\$744	\$793	\$846	25.25	24	30	18.5	18	26	28	2.5
9933 		\$538	\$576	\$614	\$652	\$702	\$752	22	19	29.5	18	19		35	2.5
9903-BS-24 		\$563	\$593	\$626	\$659	\$694	\$707	18	20	37	18	25		31	1.5
9903-BS-30		\$563	\$593	\$626	\$659	\$694	\$707	18	20	43	18	31		31	1.5

Footrail channel on stool models standard in Brass. Specify in 'SSC' Stainless Steel. *No upcharge.*



Nail Trim available, specify 'BNT' Brass, 'ANT' Antique, 'SNT' Stainless, or 'ONT' Oxford. *Add \$30 list per chair for back, \$50 list per chair for seat, and \$80 list per chair for seat and backrest.*

Front leg casters available on chair models, specify 'CA'. *Add \$40 list per chair.*

Piping and backrest in dual upholstery, specify material. *No upcharge.*

KOKO

Product information on page 40.

Model Number	PRICE							SPECIFICATIONS							
	All Wood	Fabric COM/200	Fabric Grade 300	Fabric Grade 400	Fabric Grade 500	Fabric Grade 600	Fabric Grade 700	Width	Depth	Height	Seat Depth	Seat Height	Arm Height	Weight (lbs.)	Fabric (yds.)
9633 		\$420	\$452	\$484	\$516	\$557	\$598	17.5	22.5	33	18	19		22	1.25
9633-BS-30 		\$483	\$515	\$547	\$579	\$620	\$661	19.5	20	41	17	31		30	1.25

Footrail channel on stool models standard in Brass. Specify in 'SSC' Stainless Steel. *No upcharge.*

Piping and backrest available in dual upholstery, specify material. *No upcharge.*

# LARK

Product information on page 41.

## PRICE

## SPECIFICATIONS

Model Number	All Wood	Fabric COM/200	Fabric Grade 300	Fabric Grade 400	Fabric Grade 500	Fabric Grade 600	Fabric Grade 700	Width	Depth	Height	Seat Depth	Seat Height	Arm Height	Weight (lbs.)	Fabric (yds.)
7123UBS 		\$387	\$412	\$437	\$462	\$491	\$520	17	22.5	37.5	17.5	18.5		26	1
7123UBS-BS-24 		\$437	\$462	\$487	\$512	\$541	\$570	17	22	40.75	17.5	24		34	1
7123UBS-BS-30		\$437	\$462	\$487	\$512	\$541	\$570	17	22	46.75	17.5	30		34	1









Footrail channel on stool models standard in Brass. Specify in 'SSC' Stainless Steel. *No upcharge.*

Decorative stitching available on seats and backrests, specify 'DS'. *No upcharge.*

Backrest available in dual upholstery, specify material. *No upcharge.*

# LENEXA

Product information on page 92.

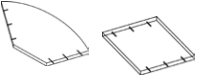
Model Number	PRICE							SPECIFICATIONS							
	All Wood	Fabric COM/200	Fabric Grade 300	Fabric Grade 400	Fabric Grade 500	Fabric Grade 600	Fabric Grade 700	Width	Depth	Height	Seat Depth	Seat Height	Arm Height	Weight (lbs.)	Fabric (yds.)
360-1 360-1-UA		\$996 \$1146	\$1042 \$1210	\$1088 \$1274	\$1138 \$1344	\$1190 \$1414	\$1242 \$1488	23.5 23.5	24.5 24.5	33.5 33.5	18.5 18.5	18 18	25.5 25.5	27 37	1.625 2.125
360-1-HB		\$1096	\$1142	\$1188	\$1238	\$1290	\$1342	23.5	25.5	44	18.5	18	25.5	37	2.5
360-2 360-2-UA		\$1516 \$1667	\$1611 \$1779	\$1698 \$1884	\$1800 \$2007	\$1902 \$2126	\$2010 \$2256	43 43	24.5 24.5	33.5 33.5	18.5 18.5	18 18	25.5 25.5	43 53	3.25 3.75
360-2-A 360-2-A-UA		\$1621 \$1846	\$1714 \$1966	\$1804 \$2083	\$1906 \$2215	\$2007 \$2343	\$2115 \$2484	45 45	24.5 24.5	33.5 33.5	18.5 18.5	18 18	25.5 25.5	48 63	3.25 4
360-3-A 360-3-A-UA		\$2537 \$2837	\$2678 \$3014	\$2812 \$3189	\$2964 \$3376	\$3116 \$3564	\$3277 \$3769	66.5 66.5	24.5 24.5	33.5 33.5	18.5 18.5	18 18	25.5 25.5	69 89	4.875 5.875
360-1-B		\$556	\$590	\$622	\$659	\$696	\$734	23.5	21	21.8	21	18	21.8	20	1
360-2-B		\$976	\$1044	\$1107	\$1181	\$1255	\$1333	43	21	21.8	21	18	21.8	32	2
360-3-B		\$1321	\$1423	\$1519	\$1630	\$1741	\$1857	63.5	21	21.8	21	18	21.8	44	3
360-CT 360-MT		\$453 \$379						31 20	19 19	15 15				18 15	

Specify Maple or Oak wood.

Upholstered arm panel, specify 'UA' when ordering.







Specify laminate top. See page 178 for selections. *No upcharge.*

# LORA

Product information on page 42.

## PRICE



## SPECIFICATIONS

Model Number	All Wood	Fabric COM/200	Fabric Grade 300	Fabric Grade 400	Fabric Grade 500	Fabric Grade 600	Fabric Grade 700	Width	Depth	Height	Seat Depth	Seat Height	Arm Height	Weight (lbs.)	Fabric (yds.)
9827US 		\$374	\$388	\$403	\$419	\$436	\$453	20	20.75	33.25	18	18.5		27	2
9827-BS-24 		\$425	\$440	\$454	\$471	\$487	\$505	20	21	37.75	18	24		32	2
9827-BS-30 		\$425	\$440	\$454	\$471	\$487	\$505	20	21	43.75	18	30		32	2
9823 		\$383	\$398	\$412	\$428	\$445	\$462	19.75	22.5	33.75	18	18.5		27	2
9823-BS-24 		\$435	\$449	\$464	\$480	\$496	\$514	20.25	21.5	34.5	18	24		32	2
9823-BS-30 		\$435	\$449	\$464	\$480	\$496	\$514	20.25	21.5	40.5	18	30		32	2

Footrail channel on stool models standard in Brass. Specify in 'SSC' Stainless Steel. No upcharge.

# LOUIE

Product information on page 43.

Model Number	PRICE							SPECIFICATIONS							
	All Wood	Fabric COM/200	Fabric Grade 300	Fabric Grade 400	Fabric Grade 500	Fabric Grade 600	Fabric Grade 700	Width	Depth	Height	Seat Depth	Seat Height	Arm Height	Weight (lbs.)	Fabric (yds.)
583 		\$578	\$636	\$690	\$751	\$814	\$879	19.5	21.5	34.5	17.5	18		24	1.5
583-BS-24 		\$638	\$695	\$749	\$812	\$873	\$939	19.5	21.25	38	17.5	24		31	1.5
583-BS-30		\$638	\$695	\$749	\$812	\$873	\$939	19.5	21.25	44	17.5	30		31	1.5

Specify vinyl for straps. *No Upcharge.*





Footrail channel on stool models standard in Brass. Specify in 'SSC' Stainless Steel. *No upcharge.*

# LYDIA

Product information on page 44 and 45.

## PRICE

## SPECIFICATIONS



Model Number	All Wood	Fabric COM/200	Fabric Grade 300	Fabric Grade 400	Fabric Grade 500	Fabric Grade 600	Fabric Grade 700	Width	Depth	Height	Seat Depth	Seat Height	Arm Height	Weight (lbs.)	Fabric (yds.)	
653 653US		\$475	\$530	\$559	\$587	\$618	\$650	\$683	18.75 18.75	21 21	34.5 34.5	17 17	18 18	25 25	.875	
657 657US		\$529	\$588	\$617	\$644	\$676	\$708	\$741	21.75 21.75	22.5 22.5	35 35	18.5 18.5	18 18	26 26	28 28	.875
654UBS 655UBS		\$546 \$565	\$579 \$598	\$611 \$630	\$647 \$667	\$683 \$702	\$720 \$740	18.75 18.75	21 21	34.5 34.5	17 17	18 18	25 25	1.25 1.25		
658UBS 659UBS		\$616 \$679	\$658 \$720	\$697 \$759	\$743 \$805	\$787 \$850	835 \$897	21.75 21.75	22.5 22.5	35 35	18.5 18.5	18 18	26 26	28 28	1.5 1.5	

Wood seat available on models 654UBS, 658UBS, 655UBS, and 659UBS. No upcharge; fabric requirement .625 yds.



## LYONS EAST

Product information on page 46.

Model Number	PRICE							SPECIFICATIONS							
	All Wood	Fabric COM/200	Fabric Grade 300	Fabric Grade 400	Fabric Grade 500	Fabric Grade 600	Fabric Grade 700	Width	Depth	Height	Seat Depth	Seat Height	Arm Height	Weight (lbs.)	Fabric (yds.)
7933 7933US 	\$489	\$535	\$549	\$562	\$577	\$592	\$607	17.63	21.38	35	16	18		24	
								17.63	21.38	35	16	18		24	.75
7931 7931US 	\$594	\$646	\$661	\$676	\$693	\$710	\$728	24.5	21.38	35	16	18	26	29	
								24.5	21.38	35	16	18	26	29	.875
7933-BS-30 7933US-BS-30 	\$569	\$616	\$630	\$643	\$658	\$673	\$688	17.63	21.38	45.5	16	30		29	
								17.63	21.38	45.5	16	30		29	.75

Specify Maple or Oak wood.



Footrail channel on stool models standard in Brass. Specify in 'SSC' Stainless Steel. *No upcharge.*

Front leg casters available on chair models, specify 'CA'. *Add \$40 list per chair.*

Decorative cutout available, specify 'C'. *Add \$20 list per chair.*

## LYONS WEST

Product information on page 47.

Model Number	PRICE							SPECIFICATIONS							
	All Wood	Fabric COM/200	Fabric Grade 300	Fabric Grade 400	Fabric Grade 500	Fabric Grade 600	Fabric Grade 700	Width	Depth	Height	Seat Depth	Seat Height	Arm Height	Weight (lbs.)	Fabric (yds.)
7963 7963US 7963UBS 	\$500	\$545	\$559	\$572	\$587	\$602	\$617	17.63	21.38	35	16	18		24	
		\$606	\$629	\$650	\$675	\$699	\$724	17.63	21.38	35	16	18		24	.75
								17.63	21.38	35	16	18		24	.75
7983 7983US 7933UBS 	\$481	\$526	\$540	\$553	\$568	\$582	\$598	17.63	21.38	35	16	18		24	
		\$600	\$623	\$644	\$669	\$694	\$719	17.63	21.38	35	16	18		24	.75
								17.63	21.38	35	16	18		24	.75

Specify Maple or Oak wood.

Wood seat available on models 7963UBS and 7933UBS. *No upcharge; fabric requirement .75 yds.*

Front leg casters available on chair models, specify 'CA'. *Add \$40 list per chair.*

# MACY EAST

Product information on page 48.

## PRICE

## SPECIFICATIONS

Model Number	All Wood	Fabric COM/200	Fabric Grade 300	Fabric Grade 400	Fabric Grade 500	Fabric Grade 600	Fabric Grade 700	Width	Depth	Height	Seat Depth	Seat Height	Arm Height	Weight (lbs.)	Fabric (yds.)
953 (shown with 'DSG') 		\$412	\$445	\$478	\$511	\$553	\$595	17.5	23	32	16.5	19		28	1.25
9803-BS-24 		\$544	\$580	\$621	\$675	\$726	\$786	18.5	21.25	34.5	16	25		38	1.25
9803-BS-30		\$544	\$580	\$621	\$675	\$726	\$786	18.5	21.25	40.5	16	31		38	1.25

Footrail channel on stool models standard in Brass. Specify in 'SSC' Stainless Steel. *No upcharge.*

Decorative stitching, specify Grid 'DSG' or Line 'DSL'. *No upcharge.*



Backrest available in dual upholstery, specify material. *No upcharge.*

# MACY WEST

Product information on page 49.

## PRICE





## SPECIFICATIONS

Model Number	All Wood	Fabric COM/200	Fabric Grade 300	Fabric Grade 400	Fabric Grade 500	Fabric Grade 600	Fabric Grade 700	Width	Depth	Height	Seat Depth	Seat Height	Arm Height	Weight (lbs.)	Fabric (yds.)
833 		\$374	\$405	\$436	\$467	\$501	\$535	17	25	35	18	19		30	1.25
9805-BS-24 		\$530	\$567	\$608	\$661	\$713	\$773	17.25	20.5	32.5	15.5	24.25		35	1.25
9805-BS-30		\$530	\$567	\$608	\$661	\$713	\$773	17.25	20.5	38.5	15.5	30.25		35	1.25
S-9802-30 		\$340	\$371	\$397	\$427	\$458	\$494	17.25	17.25	30.25				23	2.25

Footrail channel on stool models standard in Brass. Specify in 'SSC' Stainless Steel. *No upcharge.*

Decorative stitching, specify Grid 'DSG' or Line 'DSL'. *No upcharge.*

Backrest available in dual upholstery, specify material. *No upcharge.*

Model Number	PRICE							SPECIFICATIONS							
	All Wood	Fabric COM/200	Fabric Grade 300	Fabric Grade 400	Fabric Grade 500	Fabric Grade 600	Fabric Grade 700	Width	Depth	Height	Seat Depth	Seat Height	Arm Height	Weight (lbs.)	Fabric (yds.)
953-L (shown with 'DSL') 		\$608	\$673	\$737	\$802	\$887	\$971	29	26.75	32	18	17		29	2.5
R-623-18 		\$346	\$377	\$406	\$440	\$474	\$510	18		18				30	2.5
R-623-24 		\$408	\$469	\$498	\$532	\$566	\$600	24		18				50	3
R-623-36 		\$512	\$649	\$688	\$732	\$776	\$822	36		18				82	4

Decorative stitching, specify Grid 'DSG' or Line 'DSL'. *No upcharge.*







Backrest and tops available in dual upholstery, specify material. *No upcharge.*

# MARSHAL EAST

Product information on page 50.

## PRICE

## SPECIFICATIONS

Model Number	All Wood	Fabric COM/200	Fabric Grade 300	Fabric Grade 400	Fabric Grade 500	Fabric Grade 600	Fabric Grade 700	Width	Depth	Height	Seat Depth	Seat Height	Arm Height	Weight (lbs.)	Fabric (yds.)
9556 9556US		\$309						16	19.25	33.5	15	18		22	
		\$322	\$334	\$344	\$356	\$368	\$381	16	19.25	33.5	15	18		22	1.625
9556-BS-24 9556-BS-30 9556US-BS-24 9556US-BS-30		\$386						16	20.5	39.5	15	24		26	
		\$386						16	20.5	45.5	15	30		26	
		\$399	\$411	\$421	\$433	\$445	\$457	16	20.5	39.5	15	24		26	1.625
		\$399	\$411	\$421	\$433	\$445	\$457	16	20.5	45.5	15	30		26	1.625
1800 1800US		\$280						17.5	19.5	32	14.5	17.5		20	
		\$302	\$312	\$324	\$336	\$348	\$361	17.5	19.5	32	14.5	17.5		20	1.625
1800-BS-24 1800-BS-30 1800US-BS-24 1800US-BS-30		\$360						17.5	22.5	39.5	14.5	24		26	
		\$360						17.5	22.5	44.5	14.5	30		26	
		\$378	\$388	\$399	\$411	\$422	\$435	17.5	22.5	39.5	14.5	24		26	1.625
		\$378	\$388	\$399	\$411	\$422	\$435	17.5	22.5	44.5	14.5	30		26	1.625
1900 1900US		\$280						17.5	19.5	32	14.5	17.5		20	
		\$302	\$312	\$324	\$336	\$348	\$361	17.5	19.5	32	14.5	17.5		20	1.625
1900-BS-24 1900-BS-30 1900US-BS-24 1900US-BS-30		\$360						17.5	22.5	39.5	14.5	24		26	
		\$360						17.5	22.5	44.5	14.5	30		26	
		\$378	\$388	\$399	\$411	\$422	\$435	17.5	22.5	39.5	14.5	24		26	1.625
		\$378	\$388	\$399	\$411	\$422	\$435	17.5	22.5	44.5	14.5	30		26	1.625

Specify Maple or Oak wood.

Footrail channel on stool models standard in Brass. Specify in 'SSC' Stainless Steel. *No upcharge.*

Decorative cutout available on 9556 models, specify 'C' or '3C'. *Add \$20 list per chair.*

Multi-finish on seat/backrest and frame. *Add \$25 list per chair.*

Personalized laser engraving on seats or backrests. *Add \$100 list set up charge and \$50 list per chair.*











Personalized stamping on seats or backrests. *Add \$100 list set up charge and \$50 list per chair.*

# MARSHAL WEST

Product information on page 51.

## PRICE

## SPECIFICATIONS

Model Number	All Wood	Fabric COM/200	Fabric Grade 300	Fabric Grade 400	Fabric Grade 500	Fabric Grade 600	Fabric Grade 700	Width	Depth	Height	Seat Depth	Seat Height	Arm Height	Weight (lbs.)	Fabric (yds.)
436 436US		\$304	\$333	\$346	\$359	\$373	\$388	\$403	18	20.25	33	16	18	22	
436-BS-24 436-BS-30 436US-BS-24 436US-BS-30		\$377 \$377	\$406 \$406	\$419 \$419	\$432 \$342	\$446 \$446	\$461 \$461	\$476 \$476	18 18	21.5 21.5	37 37	16 16	24 30	27 27	.75 .75
1600 1600US		\$260	\$282	\$292	\$304	\$316	\$328	\$341	16	19.5	33.5	14.5	17.5	20	
1600-BS-24 1600-BS-30 1600US-BS-24 1600US-BS-30		\$340 \$340	\$358 \$358	\$368 \$368	\$379 \$379	\$391 \$391	\$402 \$402	\$415 \$415	16 16	22.5 22.5	37.5 37.5	14.5 14.5	24 30	25 25	.75 .75
1700 1700US		\$260	\$282	\$292	\$304	\$316	\$328	\$341	16	19.5	33.5	14.5	17.5	20	
1700-BS-24 1700-BS-30 1700US-BS-24 1700US-BS-30		\$340 \$340	\$358 \$358	\$368 \$368	\$379 \$379	\$391 \$391	\$402 \$402	\$415 \$415	16 16	22.5 22.5	37.5 37.5	14.5 14.5	24 30	25 25	.75 .75
433 433US 435UBS		\$299	\$335 \$384	\$349 \$411	\$362 \$436	\$377 \$465	\$391 \$493	\$408 \$523	18	19.25	34	16	17.5	23	
433-BS-24 433US-BS-24 433UBS-BS-24		\$370	\$408 \$457	\$421 \$484	\$434 \$509	\$449 \$538	\$464 \$565	\$479 \$596	18	22	38	16	24	30	
433-BS-30 433US-BS-30 433UBS-BS-30		\$370	\$408 \$457	\$421 \$484	\$434 \$509	\$449 \$538	\$464 \$565	\$479 \$596	18	22	44	16	30	30	
433-16 433US-16 433UBS-16		\$299	\$335 \$384	\$349 \$411	\$362 \$436	\$377 \$465	\$391 \$493	\$408 \$523	16	17	30	13	16	19	

Specify Maple or Oak wood.

Footrail channel on stool models standard in Brass. Specify in 'SSC' Stainless Steel. *No upcharge.*

Decorative cutout available on 436 models, specify 'C' or '3C'. *Add \$20 list per chair.*

Decorative cutout available on 433 models, specify '3L'. *Add \$20 list per chair.*

Standard frame size available on 1600 and 1700 chair models. *No upcharge.*

Personalized laser engraving on seats or backrests. *Add \$100 list set up charge and \$50 list per chair.*







Personalized stamping on seats or backrests. *Add \$100 list set up charge and \$50 list per chair.*

# MCKINLEY

Product information on page 54.

## PRICE

## SPECIFICATIONS

Model Number	All Wood	Fabric COM/200	Fabric Grade 300	Fabric Grade 400	Fabric Grade 500	Fabric Grade 600	Fabric Grade 700	Width	Depth	Height	Seat Depth	Seat Height	Arm Height	Weight (lbs.)	Fabric (yds.)
1303 1307		\$567	\$602	\$633	\$672	\$709	\$750	22	24	36	18	19.5		30	1.6
1301 1305		\$636	\$671	\$705	\$742	\$780	\$821	23.5	24	36	18	19.5	26	34	1.6
1303-BS-24 1307-BS-24		\$623	\$655	\$690	\$724	\$762	\$805	20	21.5	39.25	16.5	25.5		33	1.6
1303-BS-30 1307-BS-30		\$623	\$655	\$690	\$724	\$762	\$805	20	21.5	45.25	16.5	31.5		33	1.6
1302-BS-24 1304-BS-24		\$756	\$788	\$823	\$858	\$896	\$940	20	22.5	38.5	16.5	25.5		53	1.6
1302-BS-30 1304-BS-30		\$756	\$788	\$823	\$858	\$896	\$940	20	22.5	44.5	16.5	31.5		53	1.6

Specify Maple or Oak wood.

Footrail channel on stool models standard in Brass. Specify in 'SSC' Stainless Steel. *No upcharge.*

Traditional detailing available, specify '1307', '1305', and '1304' models when ordering.

Decorative crosswise backrest, specify 'XBA'. *Add \$50 list per chair.*

Front leg casters available on chair models, specify 'CA'. *Add \$40 list per chair.*

All leg casters available on chair models, specify 'CA4'. *Add \$80 list per chair.*

Backrest available in dual upholstery, specify material. *No upcharge.*

# MILAN

Product information on page 55.

Model Number	PRICE							SPECIFICATIONS							
	All Wood	Fabric COM/200	Fabric Grade 300	Fabric Grade 400	Fabric Grade 500	Fabric Grade 600	Fabric Grade 700	Width	Depth	Height	Seat Depth	Seat Height	Arm Height	Weight (lbs.)	Fabric (yds.)
7833US 		\$556	\$571	\$586	\$602	\$618	\$636	18.75	22.25	35.5	17.5	18		24	.875
7833US-BS-24 		\$613	\$628	\$643	\$659	\$676	\$693	19	20.5	39.75	17.5	24		21	.875
7833US-BS-30 		\$613	\$628	\$643	\$659	\$676	\$693	19	20.5	45.75	17.5	30		21	.875
S-7933US-24 		\$521	\$535	\$547	\$562	\$577	\$593	18.5	18.5	24				23	.875
S-7933US-30 		\$521	\$535	\$547	\$562	\$577	\$593	18.5	18.5	30				23	.875

Footrail channel on stool models standard in Brass. Specify in 'SSC' Stainless Steel. *No upcharge.*  
 Decorative sewn seat, specify 'SS'. *No upcharge.*









# NEENAH EAST

Product information on page 56.

## PRICE

## SPECIFICATIONS

Model Number	All Wood	Fabric COM/200	Fabric Grade 300	Fabric Grade 400	Fabric Grade 500	Fabric Grade 600	Fabric Grade 700	Width	Depth	Height	Seat Depth	Seat Height	Arm Height	Weight (lbs.)	Fabric (yds.)
547US 547UBS 		\$405	\$421	\$436	\$453	\$470	\$488	21	22	34.25	17.5	18		24	2
		\$437	\$461	\$484	\$510	\$537	\$563	21	22	34.25	17.5	18		24	2
545US 545UBS 		\$440	\$456	\$471	\$487	\$505	\$522	24.5	22	34.25	17.5	18	26	25	2
		\$471	\$495	\$518	\$544	\$570	\$596	24.5	22	34.25	17.5	18	26	25	2
547US-BS-24 547US-BS-30 547UBS-BS-24 547UBS-BS-30 		\$487	\$504	\$518	\$536	\$552	\$571	19.5	22	38.25	17.5	24		30	2
		\$487	\$504	\$518	\$536	\$552	\$571	19.5	22	44.25	17.5	30		30	2
		\$521	\$549	\$574	\$603	\$630	\$661	19.5	22	38.25	17.5	24		30	2
		\$521	\$549	\$574	\$603	\$630	\$661	19.5	22	44.25	17.5	30		30	2
533US 		\$372	\$386	\$401	\$417	\$434	\$451	19.25	22.5	34.75	18	18		25	2
531US 		\$451	\$466	\$481	\$497	\$514	\$531	19.25	22.5	34.75	18	18	26	28	2
533US-BS-24 533US-BS-30 		\$405	\$420	\$435	\$451	\$468	\$485	19.25	25	38.5	18	24		30	2
		\$405	\$420	\$435	\$451	\$468	\$485	19.25	25	44.5	18	30		30	2







Footrail channel on stool models standard in Brass. Specify in 'SSC' Stainless Steel. *No upcharge.*

Front leg casters available on chair models, specify 'CA'. *Add \$40 list per chair.*

Personalized laser engraving on backrests 547 and 545 models. *Add \$100 list set up charge and \$50 list per chair.*

# NEENAH WEST

Product information on page 58.

Model Number	PRICE							SPECIFICATIONS							
	All Wood	Fabric COM/200	Fabric Grade 300	Fabric Grade 400	Fabric Grade 500	Fabric Grade 600	Fabric Grade 700	Width	Depth	Height	Seat Depth	Seat Height	Arm Height	Weight (lbs.)	Fabric (yds.)
 543US-TC 543UBS-TC		\$405	\$420	\$435	\$452	\$469	\$487	21	22	34.25	17.5	18		24	2
 541US-TC 541UBS-TC		\$439	\$455	\$470	\$487	\$504	\$522	24.5	22	34.25	17.5	18	26	25	2
 543US-BS-24-TC 543US-BS-30-TC 543UBS-BS-24-TC 543UBS-BS-30-TC		\$487	\$492	\$517	\$534	\$551	\$569	19.5	22	38.25	17.5	24		30	2
 543US 543UBS		\$383	\$398	\$413	\$430	\$447	\$465	21	22	34.25	17.5	18		24	2
 541US 541UBS		\$417	\$433	\$448	\$465	\$482	\$500	24.5	22	34.25	17.5	18	26	25	2
 543US-BS-24 543US-BS-30 543UBS-BS-24 543UBS-BS-30		\$465	\$480	\$495	\$512	\$529	\$547	19.5	22	38.25	17.5	24		30	2

Footrail channel on stool models standard in Brass. Specify in 'SSC' Stainless Steel. *No upcharge.*

Front leg casters available on chair models, specify 'CA'. *Add \$40 list per chair.*



Personalized laser engraving on backrests. *Add \$100 list set up charge and \$50 list per chair.*

# NILES

Product information on page 59.

## PRICE

## SPECIFICATIONS

Model Number	All Wood	Fabric COM/200	Fabric Grade 300	Fabric Grade 400	Fabric Grade 500	Fabric Grade 600	Fabric Grade 700	Width	Depth	Height	Seat Depth	Seat Height	Arm Height	Weight (lbs.)	Fabric (yds.)
553US 553UBS		\$425 \$477	\$448 \$501	\$468 \$520	\$491 \$546	\$516 \$572	\$540 \$595	18.5 18.5	22 22	34.25 34.25	17.5 17.5	18 18		24 24	2 2
551US 551UBS		\$470 \$521	\$492 \$545	\$512 \$564	\$539 \$593	\$563 \$619	\$588 \$644	24.75 24.75	22 22	34.25 34.25	17.5 17.5	18 18	26 26	25 25	2 2
553US-BS-24 553US-BS-30 553UBS-BS-24 553UBS-BS-30		\$519 \$519 \$571 \$571	\$540 \$540 \$592 \$592	\$561 \$561 \$614 \$614	\$585 \$585 \$640 \$640	\$608 \$608 \$663 \$663	\$632 \$632 \$688 \$688	18.5 18.5 18.5 18.5	22 22 22 22	38.25 44.25 38.25 44.25	17.5 17.5 17.5 17.5	24 30 24 30		30 30 30 30	2 2 2 2

Footrail channel on stool models standard in Brass. Specify in 'SSC' Stainless Steel. *No upcharge.*  
 Front leg casters available on chair models, specify 'CA'. *Add \$40 list per chair.*

Model Number		PRICE						SPECIFICATIONS								
		All Wood	Fabric COM/200	Fabric Grade 300	Fabric Grade 400	Fabric Grade 500	Fabric Grade 600	Fabric Grade 700	Width	Depth	Height	Seat Depth	Seat Height	Arm Height	Weight (lbs.)	Fabric (yds.)
7303UBS			\$365	\$395	\$425	\$455	\$490	\$525	22	22	38	20	19		21	1
7303UBS-ST			\$415	\$445	\$475	\$505	\$540	\$575	22	22	37	20	19		23	1
7303UBS-BS-24			\$470	\$500	\$530	\$560	\$595	\$630	22	21	39	18.5	25		23	1
7303UBS-BS-30			\$470	\$500	\$530	\$560	\$595	\$630	22	21	45	18.5	31		23	1
7301UBS			\$527	\$557	\$587	\$617	\$652	\$687	26	23	36	20	19	26.5	29	1.25
7303UBS-BA			\$465	\$495	\$525	\$555	\$590	\$625	36	23	38	21	19		44	2
7301UBS-BA			\$639	\$669	\$699	\$729	\$764	\$799	36	23	38	21	19	26	54	2

Footrail channel on stool models standard in Brass. Specify in 'SSC' Stainless Steel. *No upcharge.*

Nail trim available, specify 'BNT' Brass, 'ANT' Antique, 'SNT' Stainless, or 'ONT' Oxford. *Add \$30 list per chair.*

Front leg casters available on chair models, specify 'CA'. *Add \$40 list per chair.*

Upholstered armpad cushion available, specify 'AP'. *Add \$40 list per chair.*

# OAKLEY

Product information on page 95.

## PRICE

## SPECIFICATIONS

Model Number	All Wood	Fabric COM/200	Fabric Grade 300	Fabric Grade 400	Fabric Grade 500	Fabric Grade 600	Fabric Grade 700	Width	Depth	Height	Seat Depth	Seat Height	Arm Height	Weight (lbs.)	Fabric (yds.)
320-1 		\$1404	\$1500	\$1591	\$1696	\$1801	\$1911	37	33	35	21.5	18.5	25.75	115	2.625
320-2 		\$1984	\$2161	\$2328	\$2518	\$2710	\$2910	60.75	33	35	21.5	18.5	25.75	150	4.625
320-3 		\$2648	\$2902	\$3140	\$3414	\$3687	\$3976	84.75	33	35	21.5	18.5	25.75	195	6.625
320-2424US-18 		\$626	\$648	\$668	\$692	\$715	\$741	24	24	18				38	.75
320-2448US-18 		\$790	\$828	\$864	\$905	\$947	\$989	24	48	18				58	1.375

Specify Maple or Oak wood.

Cushions in dual upholstery, specify material. *No upcharge.*

# OAKLEY

Product information on page 103.

## PRICE

## SPECIFICATIONS

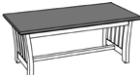
Model Number	All Edges							Width	Depth	Height	Seat Depth	Seat Height	Arm Height	Weight (lbs.)	Fabric (yds.)
L-320-2424P18 	\$696							24	24	18				50	
L-320-3232P18	\$852							32	32	18				76	
L-320-2448P18 	\$868							48	48	18				68	

Specify Maple or Oak wood.

Specify edge: 'A' Square, 'B' Bullnose, 'C' Traditional, 'D' Thumbnail, 'E' Bevel.

Specify standard laminate top. See page 178 for selections. *No upcharge.*

Select COM Laminate top. *Add \$125 list per table.*

Minimum order quantity. *Add \$80 list per table for quantities less than three per order.*

# PORTER

Product information on page 62.

Model Number	PRICE							SPECIFICATIONS							
	All Wood	Fabric COM/200	Fabric Grade 300	Fabric Grade 400	Fabric Grade 500	Fabric Grade 600	Fabric Grade 700	Width	Depth	Height	Seat Depth	Seat Height	Arm Height	Weight (lbs.)	Fabric (yds.)
863 	\$355							18	21	33	17	18.75		26	
863US 		\$386	\$412	\$438	\$464	\$530	\$597	18.5	21	33	16.5	19.5		26	2
863UBS 		\$407	\$438	\$469	\$500	\$542	\$584	18.5	21	33.25	16.5	19.5		26	2
863UBS-HH		\$427	\$458	\$479	\$520	\$562	\$604	18.5	21	33.25	16.5	19.5		26	2

Wood seat available on model 863UBS. No upcharge; fabric requirement 1.75 yds.

Multi-finish on seat and backrest. Add \$25 list per chair.

Personalized laser engraving on seats. Add \$100 list set up charge and \$50 list per chair.

# SAMARA

Product information on page 64.

## PRICE

## SPECIFICATIONS

Model Number	All Wood	Fabric COM/200	Fabric Grade 300	Fabric Grade 400	Fabric Grade 500	Fabric Grade 600	Fabric Grade 700	Width	Depth	Height	Seat Depth	Seat Height	Arm Height	Weight (lbs.)	Fabric (yds.)
835 		\$505	\$570	\$634	\$699	\$783	\$866	23	26	40	18	20		39	3
839-BS-30 		\$489	\$541	\$592	\$644	\$711	\$778	22	21.75	41.75	18	30.5		39	2.25

Backrest/arms and seat available in dual upholstery, specify material. *No upcharge.*



# SELINA

Product information on page 66.

Model Number	PRICE							SPECIFICATIONS							
	All Wood	Fabric COM/200	Fabric Grade 300	Fabric Grade 400	Fabric Grade 500	Fabric Grade 600	Fabric Grade 700	Width	Depth	Height	Seat Depth	Seat Height	Arm Height	Weight (lbs.)	Fabric (yds.)
693 		\$546	\$609	\$667	\$735	\$803	\$874	18	25.5	41.25	16.5	18		25	1.625
693-BS-24 		\$645	\$707	\$766	\$834	\$902	\$973	18	24.75	40.5	16.5	24		26	1.625
693-BS-30 		\$645	\$707	\$766	\$834	\$902	\$973	18	24.75	46.25	16.5	30		27	1.625
S-693US-24 		\$259	\$270	\$280	\$290	\$303	\$315	16.5	16.5	24				23	.625
S-693US-30 		\$259	\$270	\$280	\$290	\$303	\$315	16.5	16.5	30				23	.625

Footrail channel and rings on stool models standard in Brass. Specify in 'SSC' or 'SSR' Stainless Steel. *No upcharge.*



Nail trim available along seat boarder, specify 'BNT' Brass, 'ANT' Antique, 'SNT' Stainless, or 'ONT' Oxford. *Add \$50 list per chair.*

# SIDNEY

Product information on page 67.

## PRICE

## SPECIFICATIONS

Model Number	All Wood	Fabric COM/200	Fabric Grade 300	Fabric Grade 400	Fabric Grade 500	Fabric Grade 600	Fabric Grade 700	Width	Depth	Height	Seat Depth	Seat Height	Arm Height	Weight (lbs.)	Fabric (yds.)
613 		\$531	\$579	\$625	\$678	\$730	\$786	19	24	37.5	18	19.5		26	1.625
611 		\$621	\$672	\$720	\$775	\$829	\$887	24.5	24	37.5	18	19.5	26.25	30	1.75
615		\$634	\$686	\$733	\$789	\$844	\$902	26	24	37.5	18	19.5	26.25	30	1.75
613-BS-24 		\$606	\$653	\$699	\$752	\$804	\$859	19	23	39	18	25.5		25	1.625
613-BS-30		\$606	\$653	\$699	\$752	\$804	\$859	19	23	45	18	31.5		25	1.625

Footrail channel on stool models standard in Brass. Specify in 'SSC' Stainless Steel. *No upcharge.*

Front leg casters available on chair models, specify 'CA'. *Add \$40 list per chair.*

Upholstered armpad cushion available, specify 'AP'. *Add \$40 list per chair.*

Scroll arm available, specify '615' model when ordering.

## SITKA EAST

Product information on page 68.

Model Number	PRICE							SPECIFICATIONS							
	All Wood	Fabric COM/200	Fabric Grade 300	Fabric Grade 400	Fabric Grade 500	Fabric Grade 600	Fabric Grade 700	Width	Depth	Height	Seat Depth	Seat Height	Arm Height	Weight (lbs.)	Fabric (yds.)
643 		\$538	\$586	\$630	\$682	\$733	\$788	19	22.5	37	17	18		24	1.625
641 		\$627	\$679	\$727	\$782	\$837	\$896	22.75	22.5	37	17	18	26	26	1.75
643-BS-24 		\$637	\$685	\$730	\$781	\$833	\$886	19	21.5	38.5	17	24		29	1.625
643-BS-30		\$637	\$685	\$730	\$781	\$833	\$886	19	21.5	44.5	17	30		29	1.625

Footrail channel on stool models standard in Brass. Specify in 'SSC' Stainless Steel. *No upcharge.*

Nail trim on seat corners and backrest, specify 'BNT' Brass, 'ANT' Antique, 'SNT' Stainless, or 'ONT' Oxford. *No upcharge.*

Front leg casters available on chair models, specify 'CA'. *Add \$40 list per chair.*

Upholstered armpad cushion available, specify 'AP'. *Add \$40 list per chair.*

## SITKA WEST

Product information on page 69.

Model Number	PRICE							SPECIFICATIONS							
	All Wood	Fabric COM/200	Fabric Grade 300	Fabric Grade 400	Fabric Grade 500	Fabric Grade 600	Fabric Grade 700	Width	Depth	Height	Seat Depth	Seat Height	Arm Height	Weight (lbs.)	Fabric (yds.)
647 		\$557	\$606	\$650	\$701	\$753	\$808	19	22.5	37	17	18		24	1.625
649 		\$649	\$700	\$749	\$804	\$860	\$918	22.75	22.5	37	17	18	26	26	1.75
647-BS-24 		\$659	\$707	\$752	\$803	\$854	\$909	19	21.5	38.5	17	24		29	1.625
647-BS-30		\$659	\$707	\$752	\$803	\$854	\$909	19	21.5	44.5	17	30		29	1.625

Footrail channel on stool models standard in Brass. Specify in 'SSC' Stainless Steel. *No upcharge.*

Front leg casters available on chair models, specify 'CA'. *Add \$40 list per chair.*









Upholstered armpad cushion available, specify 'AP'. *Add \$40 list per chair.*

# TAYLOR EAST

Product information on page 70.

## PRICE

## SPECIFICATIONS

Model Numbers, 4-Leg Base	All Wood	Fabric COM/200	Fabric Grade 300	Fabric Grade 400	Fabric Grade 500	Fabric Grade 600	Fabric Grade 700	Width	Depth	Height	Seat Depth	Seat Height	Arm Height	Weight (lbs.)	Fabric (yds.)
776-18 776UB-18 776US-18 776UBS-18 	\$266							18.75	20.25	32.25	17.25	17.5		24	
		\$329	\$340	\$349	\$359	\$372	\$383	18.75	20.25	32.25	17.25	17.5		24	.625
		\$333	\$345	\$355	\$368	\$380	\$393	18.75	20.25	32.25	17.25	17.5		24	.625
		\$382	\$403	\$424	\$448	\$471	\$496	18.75	20.25	32.25	17.25	17.5		24	.625
777UBS 		\$546	\$568	\$589	\$612	\$636	\$660	18.75	20.5	30-33	17.5	16-19		50	.625
778US 778UBS 		\$419	\$432	\$444	\$456	\$469	\$484	20.5	21.25	32.25	18.25	17.5	25.5	30	.75
		\$467	\$490	\$512	\$538	\$564	\$591	20.5	21.25	32.25	18.25	17.5	25.5	30	.75
S-773-18 S-773US-18 	\$258							16	15	18				18	
		\$321	\$331	\$341	\$352	\$363	\$376	16	15	18				18	.625
S-773-28 S-773US-28 	\$289							16	15	28				20	
		\$354	\$365	\$375	\$386	\$397	\$409	16	15	28				20	.625
776-16 776UB-16 776US-16 776UBS-16 	\$266							16	17	27	14	16		19	
		\$329	\$340	\$349	\$359	\$372	\$383	16	17	27	14	16		19	.5
		\$333	\$345	\$355	\$368	\$380	\$393	16	17	27	14	16		19	.625
		\$382	\$403	\$424	\$448	\$471	\$496	16	17	27	14	16		19	.625
S-773-16 S-773US-16 	\$258							16	15	16				18	
		\$321	\$331	\$341	\$352	\$363	\$376	16	15	16				18	.625
776-14 776UB-14 776US-14 776UBS-14 	\$266							16	17	25	14	14		19	
		\$329	\$340	\$349	\$359	\$372	\$383	16	17	25	14	14		19	.5
		\$333	\$345	\$355	\$368	\$380	\$393	16	17	25	14	14		19	.625
		\$382	\$403	\$424	\$448	\$471	\$496	16	17	25	14	14		19	.625

Specify Maple or Oak wood.

Ganging hardware available, specify 'GGH'. Add \$28 list per chair.







Personalized laser engraving on seats or backrest. Add \$100 list set up charge and \$50 list per chair.

# TAYLOR EAST

Product information on page 70.

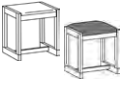
## PRICE

## SPECIFICATIONS

Model Number, Sled Base	PRICE							SPECIFICATIONS								
	All Wood	Fabric COM/200	Fabric Grade 300	Fabric Grade 400	Fabric Grade 500	Fabric Grade 600	Fabric Grade 700	Width	Depth	Height	Seat Depth	Seat Height	Arm Height	Weight (lbs.)	Fabric (yds.)	
776-SB-18 776UB-SB-18 776US-SB-18 776UBS-SB-18		\$266						18.75	20.25	32.25	17.25	17.5		24		
		\$329	\$340	\$349	\$359	\$372	\$383	18.75	20.25	32.25	17.25	17.5		24	.625	
		\$333	\$345	\$355	\$368	\$380	\$393	18.75	20.25	32.25	17.25	17.5		24	.625	
		\$382	\$403	\$424	\$448	\$471	\$496	18.75	20.25	32.25	17.25	17.5		24	.625	
778US-SB 778UBS-SB			\$419	\$432	\$444	\$456	\$469	\$484	20.5	21.25	32.25	18.25	17.5	25.5	30	.75
		\$467	\$490	\$512	\$538	\$564	\$591	20.5	21.25	32.25	18.25	17.5	25.5	30	.75	
773-SB-28 773UB-SB-28 773US-SB-28 773UBS-SB-28		\$325						16	19.75	43	17	28		25		
		\$394	\$403	\$412	\$422	\$432	\$443	16	19.75	43	17	28		25	.5	
		\$400	\$411	\$422	\$434	\$447	\$459	16	19.75	43	17	28		25	.625	
		\$439	\$461	\$483	\$507	\$530	\$556	16	19.75	43	17	28		25	.625	
S-773-SB-18 S-773US-SB-18		\$258						16	15	18				18		
		\$321	\$331	\$341	\$352	\$363	\$376	16	15	18				18	.625	
S-773-SB-28 S-773US-SB-28		\$289						16	15	28				20		
		\$354	\$365	\$375	\$386	\$397	\$409	16	15	28				20	.625	
776-SB-16 776UB-SB-16 776US-SB-16 776UBS-SB-16		\$266						16	17	27	14	16		19		
		\$329	\$340	\$349	\$359	\$372	\$383	16	17	27	14	16		19	.5	
		\$333	\$345	\$355	\$368	\$380	\$393	16	17	27	14	16		19	.625	
		\$382	\$403	\$424	\$448	\$471	\$496	16	17	27	14	16		19	.625	
S-773-SB-16 S-773US-SB-16		\$258						16	15	16				18		
		\$321	\$331	\$341	\$352	\$363	\$376	16	15	16				18	.625	
776-SB-14 776UB-SB-14 776US-SB-14 776UBS-SB-14		\$266						16	17	25	14	14		19		
		\$329	\$340	\$349	\$359	\$372	\$383	16	17	25	14	14		19	.5	
		\$333	\$345	\$355	\$368	\$380	\$393	16	17	25	14	14		19	.625	
		\$382	\$403	\$424	\$448	\$471	\$496	16	17	25	14	14		19	.625	

Specify Maple or Oak wood.

Ganging hardware available, specify 'GGH'. Add \$28 list per chair.

Personalized laser engraving on seats or backrest. Add \$100 list set up charge and \$50 list per chair.

# TAYLOR EAST

Product information on page 96.

## PRICE

## SPECIFICATIONS

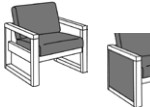
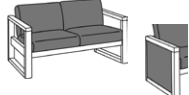
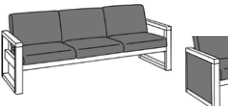
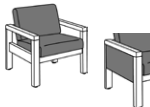
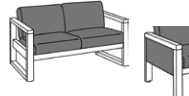
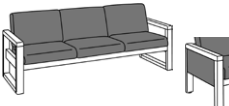
Model Number	All Wood	Fabric COM/200	Fabric Grade 300	Fabric Grade 400	Fabric Grade 500	Fabric Grade 600	Fabric Grade 700	Width	Depth	Height	Seat Depth	Seat Height	Arm Height	Weight (lbs.)	Fabric (yds.)
174-1-SB 174-1-P-SB		\$1127 \$1477	\$1190 \$1618	\$1249 \$1752	\$1317 \$1904	\$1386 \$2058	\$1458 \$2219	30.25 30.25	33.5 33.5	30.25 30.25	22.5 22.5	16 16	24 24	80 113	1.875 4.5
174-2-SB 174-2-P-SB		\$1748 \$2150	\$1875 \$2378	\$1994 \$2595	\$2131 \$2843	\$2267 \$3091	\$2411 \$3353	54.4 54.4	33.5 33.5	30.25 30.25	22.5 22.5	16 16	24 24	115 155	3.75 6
174-3-SB 174-3-P-SB		\$2497 \$2974	\$2685 \$3280	\$2864 \$3568	\$3070 \$3897	\$3275 \$4230	\$3491 \$4577	78.75 78.75	33.5 33.5	30.25 30.25	22.5 22.5	16 16	24 24	151 196	5.5 8
174-1 174-1-P		\$1088 \$1427	\$1152 \$1560	\$1211 \$1687	\$1279 \$1831	\$1348 \$1977	\$1420 \$2128	30.25 30.25	33.5 33.5	30.25 30.25	22.5 22.5	16 16	24 24	80 86	1.875 3.5
174-2 174-2-P		\$1709 \$2062	\$1835 \$2243	\$1954 \$2414	\$2092 \$2612	\$2229 \$2807	\$2372 \$3015	54.5 54.5	33.5 33.5	30.25 30.25	22.5 22.5	16 16	24 24	109 133	3.75 4.75
174-3 174-3-P		\$2459 \$2867	\$2647 \$3106	\$2827 \$3331	\$3031 \$3591	\$3237 \$3849	\$3453 \$4121	78.75 78.75	33.5 33.5	30.25 30.25	22.5 22.5	16 16	24 24	143 169	5.5 6.25

Specify Maple or Oak wood.





Cushions in dual upholstery, specify material. *No upcharge.*

# TAYLOR WEST

Product information on page 72.

## PRICE

## SPECIFICATIONS

Model Number, 4-Leg Base	All Wood	Fabric COM/200	Fabric Grade 300	Fabric Grade 400	Fabric Grade 500	Fabric Grade 600	Fabric Grade 700	Width	Depth	Height	Seat Depth	Seat Height	Arm Height	Weight (lbs.)	Fabric (yds.)
173-18 173UB-18 173US-18 173UBS-18		\$284						18.75	20.25	31.75	16.5	17.5		25	
		\$348	\$358	\$368	\$379	\$390	\$402	18.75	20.25	31.75	16.5	17.5		25	.625
		\$349	\$361	\$373	\$385	\$398	\$412	18.75	20.25	31.75	16.5	17.5		25	.625
		\$411	\$433	\$453	\$478	\$502	\$526	18.75	20.25	31.75	16.5	17.5		25	.625
171 171UB 171US 171UBS		\$359						20.5	21.25	31.75	17.5	17.5	26	30	
		\$431	\$443	\$453	\$466	\$479	\$491	20.5	21.25	31.75	17.5	17.5	26	30	.625
		\$432	\$445	\$456	\$470	\$484	\$497	20.5	21.25	31.75	17.5	17.5	26	30	.75
		\$491	\$516	\$539	\$564	\$591	\$618	20.5	21.25	31.75	17.5	17.5	26	30	.75
173-16 173UB-16 173US-16 173UBS-16		\$284						16	16.75	28	13	16		20	
		\$348	\$358	\$368	\$379	\$390	\$402	16	16.75	28	13	16		20	.5
		\$349	\$361	\$373	\$385	\$398	\$412	16	16.75	28	13	16		20	.625
		\$411	\$433	\$453	\$478	\$502	\$526	16	16.75	28	13	16		20	.625
173-14 173UB-14 173US-14 173UBS-14		\$284						16	16.75	26	13	14		20	
		\$348	\$358	\$368	\$379	\$390	\$402	16	16.75	26	13	14		20	.5
		\$349	\$361	\$373	\$385	\$398	\$412	16	16.75	26	13	14		20	.625
		\$411	\$433	\$453	\$478	\$502	\$526	16	16.75	26	13	14		20	.625
172UBS			\$573	\$595	\$616	\$641	\$664	\$690	18.75	20.25	30-33	16.5	16-19	50	.625

Specify Maple or Oak wood.

Ganging hardware available, specify 'GGH'. Add \$28 list per chair.





































Personalized laser engraving on seats or backrest. Add \$100 list set up charge and \$50 list per chair.

# TAYLOR WEST

Product information on page 72.

## PRICE

## SPECIFICATIONS

Model Number, Sled Base	All Wood	Fabric COM/200	Fabric Grade 300	Fabric Grade 400	Fabric Grade 500	Fabric Grade 600	Fabric Grade 700	Width	Depth	Height	Seat Depth	Seat Height	Arm Height	Weight (lbs.)	Fabric (yds.)
173-SB-18 	\$284							18.75	20.25	31.75	16.5	17.5		25	
173UB-SB-18 		\$348	\$358	\$368	\$379	\$390	\$402	18.75	20.25	31.75	16.5	17.5		25	.625
173US-SB-18 		\$349	\$361	\$373	\$385	\$398	\$412	18.75	20.25	31.75	16.5	17.5		25	.625
173UBS-SB-18 		\$411	\$433	\$453	\$478	\$502	\$526	18.75	20.25	31.75	16.5	17.5		25	.625
171-SB 	\$359							20.5	21.25	31.75	17.5	17.5	26	30	
171UB-SB 		\$431	\$443	\$453	\$466	\$479	\$491	20.5	21.25	31.75	17.5	17.5	26	30	.625
171US-SB 		\$432	\$445	\$456	\$470	\$484	\$497	20.5	21.25	31.75	17.5	17.5	26	30	.75
171UBS-SB 		\$491	\$516	\$539	\$564	\$591	\$618	20.5	21.25	31.75	17.5	17.5	26	30	.75
173-SB-16 	\$284							16	16.75	28	13	16		20	
173UB-SB-16 		\$348	\$358	\$368	\$379	\$390	\$402	16	16.75	28	13	16		20	.5
173US-SB-16 		\$349	\$361	\$373	\$385	\$398	\$412	16	16.75	28	13	16		20	.625
173UBS-SB-16 		\$411	\$433	\$453	\$478	\$502	\$526	16	16.75	28	13	16		20	.625
173-SB-14 	\$284							16	16.75	26	13	14		20	
173UB-SB-14 		\$348	\$358	\$368	\$379	\$390	\$402	16	16.75	26	13	14		20	.5
173US-SB-14 		\$349	\$361	\$373	\$385	\$398	\$412	16	16.75	26	13	14		20	.625
173UBS-SB-14 		\$411	\$433	\$453	\$478	\$502	\$526	16	16.75	26	13	14		20	.625
177-18 	\$321							18.75	18.75	31.75	16.5	17.5		28	
177UB-18 		\$387	\$398	\$408	\$418	\$430	\$441	18.75	18.75	31.75	16.5	17.5		28	.625
177US-18 		\$388	\$400	\$412	\$424	\$437	\$451	18.75	18.75	31.75	16.5	17.5		28	.625
177UBS-18 		\$449	\$471	\$491	\$516	\$540	\$564	18.75	18.75	31.75	16.5	17.5		28	.625
175-18 	\$353							20.5	18.75	31.75	16.5	17.5	25	30	
175UB-18 		\$425	\$437	\$448	\$460	\$472	\$486	20.5	18.75	31.75	16.5	17.5	25	30	.625
175US-18 		\$426	\$439	\$451	\$465	\$479	\$492	20.5	18.75	31.75	16.5	17.5	25	30	.75
175UBS-18 		\$487	\$511	\$534	\$560	\$586	\$613	20.5	18.75	31.75	16.5	17.5	25	30	.75
177-16 	\$321							16	18.25	27	14	15.5		21	
177UB-16 		\$387	\$398	\$408	\$418	\$430	\$441	16	18.25	27	14	15.5		21	.5
177US-16 		\$388	\$400	\$412	\$424	\$437	\$451	16	18.25	27	14	15.5		21	.625
177UBS-16 		\$449	\$471	\$491	\$516	\$540	\$564	16	18.25	27	14	15.5		21	.625
3-177-18 	\$339							18.75	27.5	31.75	16.5	17.5		28	
3-177UB-18 		\$404	\$415	\$424	\$435	\$447	\$458	18.75	27.5	31.75	16.5	17.5		28	.625
3-177US-18 		\$405	\$417	\$428	\$441	\$454	\$568	18.75	27.5	31.75	16.5	17.5		28	.625
3-177UBS-18 		\$466	\$488	\$508	\$533	\$557	\$581	18.75	27.5	31.75	16.5	17.5		28	.625
3-175-18 	\$370							20.5	27.5	31.75	16.5	17.5	25	31	
3-175UB-18 		\$443	\$454	\$465	\$478	\$489	\$503	20.5	27.5	31.75	16.5	17.5	25	31	.625
3-175US-18 		\$444	\$456	\$468	\$482	\$495	\$509	20.5	27.5	31.75	16.5	17.5	25	31	.75
3-175UBS-18 		\$504	\$528	\$551	\$577	\$603	\$630	20.5	27.5	31.75	16.5	17.5	25	31	.75

Specify Maple or Oak wood.

Ganging hardware available, specify 'GGH'. Add \$28 list per chair.

Personalized laser engraving on seats or backrest. Add \$100 list set up charge and \$50 list per chair.



# TAYLOR WEST

Product information on page 97.



Model Number	PRICE							SPECIFICATIONS							
	All Wood	Fabric COM/200	Fabric Grade 300	Fabric Grade 400	Fabric Grade 500	Fabric Grade 600	Fabric Grade 700	Width	Depth	Height	Seat Depth	Seat Height	Arm Height	Weight (lbs.)	Fabric (yds.)
84-1 84-2		\$830 \$1418	\$881 \$1517	\$927 \$1612	\$982 \$1719	\$1034 \$1827	\$1092 \$1939	24 45	27.5 27.5	30 30	19.5 19.5	15.5 15.5	22 22	51 81	2.375 4.75
84-3		\$2038	\$2188	\$2328	\$2490	\$2651	\$2821	65	27.5	30	19.5	15.5	22	112	7
86W 86US		\$718	\$688	\$727	\$763	\$804	\$846	48 48	19.5 19.5	18 18				60 45	2
84-1-SB 84-2-SB		\$830 \$1418	\$881 \$1517	\$927 \$1612	\$982 \$1719	\$1034 \$1827	\$1092 \$1939	24 45	27.5 27.5	30 30	19.5 19.5	15.5 15.5	22 22	51 81	2.375 4.75
84-3-SB		\$2038	\$2188	\$2328	\$2490	\$2651	\$2821	65	27.5	30	19.5	15.5	22	112	7
86-SB-W 86-SB-US		\$718	\$688	\$727	\$763	\$804	\$846	48 48	19.5 19.5	18 18				57 45	2

Specify Maple or Oak wood.

Cushions in dual upholstery, specify material. *No upcharge.*

# TAYLOR

Product information on page 103.

Model Number	PRICE		SPECIFICATIONS							
	HPL Self Edge	WOOD Shape Edge	Width	Depth	Height	Seat Depth	Seat Height	Arm Height	Weight (lbs.)	Fabric (yds.)
L-80-2424P18 L-80-3232P18 L-80-2448P18		\$434 \$485 \$505	\$467 \$522 \$543	24 32 48	24 32 24	18 18 18				28 42 46
L-80-36RP18		\$596	\$671	36	36	18				42

Specify edge: 'A' Square, 'B' Bullnose, 'C' Traditional, 'D' Thumbnail, 'E' Bevel, 'S' HPL Self

Specify standard laminate top. See page 178 for selections. *No upcharge.*

Select COM laminate tops. *Add \$125 list per table.*







Minimum order quantity. *Add \$80 list per table for quantities less than three per order.*

# TIFFIN

Product information on page 74.

## PRICE

## SPECIFICATIONS

Model Number, 4-Leg Base	All Wood	Fabric COM/200	Fabric Grade 300	Fabric Grade 400	Fabric Grade 500	Fabric Grade 600	Fabric Grade 700	Width	Depth	Height	Seat Depth	Seat Height	Arm Height	Weight (lbs.)	Fabric (yds.)
973-18 973UB-18 973US-18 973UBS-18 	\$328	\$394	\$403	\$411	\$420	\$430	\$439	18.75	21	32.25	17	17.5		25	
		\$398	\$410	\$420	\$433	\$447	\$459	18.75	21	32.25	17	17.5		25	.625
		\$459	\$480	\$500	\$522	\$545	\$569	18.75	21	32.25	17	17.5		25	.625
971 971UB 971US 971UBS 	\$404	\$478	\$486	\$494	\$504	\$514	\$523	20.5	22.25	33.25	17.5	18	25.5	30	
		\$481	\$493	\$505	\$519	\$531	\$546	20.5	22.25	33.25	17.5	18	25.5	30	.625
		\$536	\$559	\$582	\$608	\$634	\$659	20.5	22.25	33.25	17.5	18	25.5	30	.75
S-973-18 S-973US-18 	\$267	\$329	\$341	\$352	\$365	\$378	\$391	16	16	18				18	
		\$329	\$341	\$352	\$365	\$378	\$391	16	16	18				18	.625
973-16 973UB-16 973US-16 973UBS-16 	\$328	\$394	\$403	\$411	\$420	\$430	\$439	16	17	28.75	13.5	16		20	
		\$398	\$410	\$420	\$433	\$447	\$459	16	17	28.75	13.5	16		20	.625
		\$459	\$480	\$500	\$522	\$545	\$569	16	17	28.75	13.5	16		20	.625
S-973-16 S-973US-16 	\$267	\$329	\$341	\$352	\$365	\$378	\$391	16	16	16				18	
		\$329	\$341	\$352	\$365	\$378	\$391	16	16	16				18	.625
973-14 973UB-14 973US-14 973UBS-14 	\$328	\$394	\$403	\$411	\$420	\$430	\$439	16	17	26.75	13.5	14		19	
		\$398	\$410	\$420	\$433	\$447	\$459	16	17	26.75	13.5	14		19	.625
		\$459	\$480	\$500	\$522	\$545	\$569	16	17	26.75	13.5	14		19	.625









Specify Maple or Oak wood.

Ganging hardware available, specify 'GGH'. Add \$28 list per chair.

Personalized laser engraving on seats or backrest. Add \$100 list set up charge and \$50 list per chair.

PRICE

SPECIFICATIONS

Model Number, Sled Base	PRICE							SPECIFICATIONS							
	All Wood	Fabric COM/200	Fabric Grade 300	Fabric Grade 400	Fabric Grade 500	Fabric Grade 600	Fabric Grade 700	Width	Depth	Height	Seat Depth	Seat Height	Arm Height	Weight (lbs.)	Fabric (yds.)
973-SB-18 973UB-SB-18 973US-SB-18 973UBS-SB-18		\$328						18.75	21	32.25	17	17.5		25	
		\$394	\$403	\$411	\$420	\$430	\$439	18.75	21	32.25	17	17.5		25	.625
		\$398	\$410	\$420	\$433	\$447	\$459	18.75	21	32.25	17	17.5		25	.625
		\$459	\$480	\$500	\$522	\$545	\$569	18.75	21	32.25	17	17.5		25	.625
971-SB 971UB-SB 971US-SB 971UBS-SB		\$404						20.5	22.25	32.25	17.5	18	25.5		
		\$478	\$486	\$494	\$504	\$514	\$523	20.5	22.25	32.25	17.5	18	25.5	30	.75
		\$481	\$493	\$505	\$519	\$531	\$546	20.5	22.25	32.25	17.5	18	25.5	30	.75
		\$536	\$559	\$582	\$608	\$634	\$659	20.5	22.25	32.25	17.5	18	25.5	30	.75
973-SB-28 973UB-SB-28 973US-SB-28 973UBS-SB-28		\$354						16	19.75	43.5	17	28		25	
		\$424	\$433	\$440	\$450	\$458	\$468	16	19.75	43.5	17	28		25	.625
		\$426	\$438	\$450	\$462	\$475	\$489	16	19.75	43.5	17	28		25	.625
		\$489	\$510	\$530	\$553	\$576	\$599	16	19.75	43.5	17	28		25	.625
S-973-SB-18 S-973US-SB-18		\$267						16	16	18				18	
		\$329	\$341	\$352	\$365	\$378	\$391	16	16	18				18	.625
S-973-SB-28 S-973US-SB-28		\$294						16	16	28				19	
		\$358	\$370	\$381	\$393	\$406	\$420	16	16	28				19	.625
973-SB-16 973UB-SB-16 973US-SB-16 973UBS-SB-16		\$328						16	17	28.75	13.5	16		20	
		\$394	\$403	\$411	\$420	\$430	\$439	16	17	28.75	13.5	16		20	.625
		\$398	\$410	\$420	\$433	\$447	\$459	16	17	28.75	13.5	16		20	.625
		\$459	\$480	\$500	\$522	\$545	\$569	16	17	28.75	13.5	16		20	.625
S-973-SB-16 S-973US-SB-16		\$267						16	16	16				18	
		\$329	\$341	\$352	\$365	\$378	\$391	16	16	16				18	.625
973-SB-14 973UB-SB-14 973US-SB-14 973UBS-SB-14		\$328						16	17	26.75	13.5	14		19	
		\$394	\$403	\$411	\$420	\$430	\$439	16	17	26.75	13.5	14		19	.625
		\$398	\$410	\$420	\$433	\$447	\$459	16	17	26.75	13.5	14		19	.625
		\$459	\$480	\$500	\$522	\$545	\$569	16	17	26.75	13.5	14		19	.625

Specify Maple or Oak wood.

Ganging hardware available, specify 'GGH'. Add \$28 list per chair.

Personalized laser engraving on seats or backrest. Add \$100 list set up charge and \$50 list per chair.

# TIFFIN

Product information on page 74.

## PRICE

## SPECIFICATIONS

Model Number	All Wood	Fabric COM/200	Fabric Grade 300	Fabric Grade 400	Fabric Grade 500	Fabric Grade 600	Fabric Grade 700	Width	Depth	Height	Seat Depth	Seat Height	Arm Height	Weight (lbs.)	Fabric (yds.)
977-18	\$363							18.75	22.5	32.5	17.5	17.5		27	
977UB-18		\$433	\$441	\$450	\$458	\$468	\$478	18.75	22.5	32.5	17.5	17.5		27	.625
977US-18		\$436	\$448	\$458	\$472	\$485	\$497	18.75	22.5	32.5	17.5	17.5		27	.625
977UBS-18		\$497	\$518	\$538	\$561	\$584	\$608	18.75	22.5	32.5	17.5	17.5		27	.625
977-16	\$363							16	18.25	27.5	14	15.5		21	
977UB-16		\$433	\$441	\$450	\$458	\$468	\$478	16	18.25	27.5	14	15.5		21	.625
977US-16		\$436	\$448	\$458	\$472	\$485	\$497	16	18.25	27.5	14	15.5		21	.625
977UBS-16		\$497	\$518	\$538	\$461	\$584	\$608	16	18.25	27.5	14	15.5		21	.625
3-977-18	\$380							18.75	27.5	32.5	17.5	17.5		27	
3-977UB-18		\$450	\$458	\$467	\$475	\$485	\$494	18.75	27.5	32.5	17.5	17.5		27	.625
3-977US-18		\$453	\$465	\$475	\$489	\$502	\$515	18.75	27.5	32.5	17.5	17.5		27	.75
3-977UBS-18		\$515	\$535	\$555	\$578	\$600	\$625	18.75	27.5	32.5	17.5	17.5		27	.75

Specify Maple or Oak wood.

Ganging hardware available, specify 'GGH'. Add \$28 list per chair.

Personalized laser engraving on seats or backrest. Add \$100 list set up charge and \$50 list per chair.

TIFFIN

Product information on page 98.

Model Number	PRICE							SPECIFICATIONS							
	All Wood	Fabric COM/200	Fabric Grade 300	Fabric Grade 400	Fabric Grade 500	Fabric Grade 600	Fabric Grade 700	Width	Depth	Height	Seat Depth	Seat Height	Arm Height	Weight (lbs.)	Fabric (yds.)
11-96-1 11-96-1-P		\$1011 \$1159	\$1073 \$1255	\$1131 \$1345	\$1198 \$1449	\$1265 \$1553	\$1335 \$1662	27 27	32 32	31 31	22.5 22.5	16 16	24 24	55 78	1.875 2.625
11-96-2 11-96-2-P		\$1599 \$1810	\$1722 \$1975	\$1838 \$2129	\$1970 \$2306	\$2103 \$2484	\$2243 \$2671	51.25 51.25	32 32	31 31	22.5 22.5	16 16	24 24	75 98	3.875 4.5
11-96-3 11-96-3-P		\$2308 \$2562	\$2492 \$2793	\$2667 \$3012	\$2864 \$3263	\$3064 \$3514	\$3273 \$3778	75.5 75.5	32 32	31 31	22.5 22.5	16 16	24 24	104 138	5.5 6.25
11-96-1-SB 11-96-1-P-SB		\$1040 \$1216	\$1101 \$1341	\$1160 \$1460	\$1227 \$1594	\$1293 \$1730	\$1363 \$1873	27 27	32 32	31 31	22.5 22.5	16 16	24 24	60 87	1.875 3.375
11-96-2-SB 11-96-2-P-SB		\$1627 \$1864	\$1750 \$2056	\$1866 \$2237	\$1999 \$2444	\$2132 \$2652	\$2272 \$2871	51.25 51.25	32 32	31 31	22.5 22.5	16 16	24 24	98 107	3.375 5.25
11-96-3-SB 11-96-3-P-SB		\$2336 \$2618	\$2520 \$2877	\$2693 \$3121	\$2891 \$3402	\$3092 \$3681	\$3302 \$3977	75.5 75.5	32 32	31 31	22.5 22.5	16 16	24 24	130 145	5.5 7



Specify Maple or Oak wood.

Ganging hardware available, specify 'GGH'. Add \$28 list per chair.

Cushions in dual upholstery, specify material. No upcharge.

TIFFIN

Product information on page 103.

Model Number	PRICE		SPECIFICATIONS							
	HPL Self Edge	Wood A-E Edge	Width	Depth	Height	Seat Depth	Seat Height	Arm Height	Weight (lbs.)	Fabric (yds.)
L-80-2424P18 L-80-2448P18 L-80-3232P18		\$434 \$505 \$485	\$467 \$543 \$522	24 48 32	24 24 32	18 18 18				28 46 42
L-80-36RP18		\$596	\$671	36		18				42

Specify edge: 'A' Square, 'B' Bullnose, 'C' Traditional, 'D' Thumbnail, 'E' Bevel, 'S' HPL Self

Specify laminate tops. See page 178 for selections. No upcharge.

Select COM laminate tops. Add \$125 list per table.

Minimum order quantity. Add \$80 list per table for quantities less than three per order.

# TINLEY

Product information on page 76.

## PRICE

## SPECIFICATIONS

Model Number	All Wood	Fabric COM/200	Fabric Grade 300	Fabric Grade 400	Fabric Grade 500	Fabric Grade 600	Fabric Grade 700	Width	Depth	Height	Seat Depth	Seat Height	Arm Height	Weight (lbs.)	Fabric (yds.)
2200-20 2200UB-20 2200US-20 2200UBS-20	\$377	\$381	\$398	\$414	\$432	\$451	\$470	19.5	21.5	32.75	15.5	17		19	
		\$375	\$388	\$401	\$416	\$431	\$447	19.5	21.5	32.75	15.5	17		19	.75
		\$369	\$398	\$424	\$455	\$485	\$518	19.5	21.5	32.75	15.5	17		19	.75
2202-BS-30 2202UB-BS-30 2202US-BS-30 2202UBS-BS-30	\$457	\$461	\$478	\$494	\$512	\$531	\$550	19.5	22	46	15.5	30		26	
		\$455	\$468	\$481	\$496	\$511	\$527	19.5	22	46	15.5	30		26	.75
		\$449	\$478	\$504	\$535	\$565	\$598	19.5	22	46	15.5	30		26	.75
2204-20 2204UB-20 2204US-20 2204UBS-20	\$424	\$430	\$447	\$462	\$481	\$499	\$518	19.5	21.5	32.75	15.5	17		20	
		\$423	\$437	\$451	\$466	\$481	\$496	19.5	21.5	32.75	15.5	17		20	.75
		\$416	\$445	\$471	\$502	\$533	\$564	19.5	21.5	32.75	15.5	17		20	.75
2202-20 2202UB-20 2202US-20 2202UBS-20	\$420	\$426	\$444	\$459	\$478	\$495	\$515	19.5	21.5	32.75	15.5	17		20	
		\$419	\$433	\$446	\$460	\$476	\$491	19.5	21.5	32.75	15.5	17		20	.75
		\$416	\$445	\$471	\$502	\$533	\$564	19.5	21.5	32.75	15.5	17		20	.75
2203-20 2203UB-20 2203US-20 2203UBS-20	\$431	\$437	\$454	\$470	\$488	\$506	\$525	19.5	24	32.75	15.5	17		23	
		\$431	\$444	\$457	\$471	\$486	\$502	19.5	24	32.75	15.5	17		23	.75
		\$430	\$458	\$485	\$515	\$545	\$577	19.5	24	32.75	15.5	17		23	.75









Ganging hardware available, specify 'GGH'. Add \$28 list per chair.

Decorative cutout available, specify '3L'. Add \$20 list per chair.

Multi-finish on seat and frame. Add \$25 list per chair.

# WALTON EAST

Product information on page 78.

Model Number	PRICE							SPECIFICATIONS							
	All Wood	Fabric COM/200	Fabric Grade 300	Fabric Grade 400	Fabric Grade 500	Fabric Grade 600	Fabric Grade 700	Width	Depth	Height	Seat Depth	Seat Height	Arm Height	Weight (lbs.)	Fabric (yds.)
<b>FULL EXTENDED BACKREST MODELS</b>															
503 503US		\$271	\$298	\$311	\$324	\$338	\$352	\$368	18	21.75	35	14.75	17.5	22	
501 501US		\$357	\$394	\$410	\$424	\$441	\$457	\$474	23.5	23	35	15.75	17.5	26	28
103-BS-24 103-BS-30 103US-BS-24 103US-BS-30		\$363 \$363	\$390 \$390	\$403 \$403	\$416 \$416	\$430 \$430	\$444 \$444	\$460 \$460	18 18	20.25 20.25	36 43	14.75 14.75	24 30	28 28	.625 .625
102-BS-24 102-BS-30 102US-BS-24 102US-BS-30		\$480 \$480	\$547 \$547	\$559 \$559	\$570 \$570	\$582 \$582	\$596 \$596	\$609 \$609	18 18	20.25 20.25	36 43	14.75 14.75	24 30	36 36	.625 .625
103 103US 104 104US		\$271 \$357	\$298 \$394	\$311 \$410	\$324 \$424	\$338 \$441	\$352 \$457	\$368 \$474	18 18	21.75 21.75	35 35	14.75 14.75	17.5 17.5	22 22	.875 .875
<b>CLEAN THROUGH BACKREST MODELS</b>															
107 107US 1107 1107US		\$278 \$278	\$305 \$305	\$318 \$318	\$331 \$331	\$345 \$345	\$359 \$359	\$375 \$375	18 18	21.75 21.5	35 35.5	14.75 14.75	17.5 17.5	22 22	.875 .875
105 105US 1101 1101US		\$354 \$354	\$390 \$390	\$405 \$405	\$419 \$419	\$436 \$436	\$452 \$452	\$470 \$470	23.5 23.5	23 23.25	35 35.5	15.75 15.75	17.5 17.5	26 26	28 28
107-BS-30 107-US-30 1103-BS-30 1103US-BS-30		\$377 \$377	\$443 \$443	\$456 \$456	\$470 \$470	\$485 \$485	\$500 \$500	\$516 \$516	18 18	20.25 20	45.5 44	14.75 14.75	30 30	28 28	.75 .75
507 507US 506 506US		\$278 \$354	\$305 \$390	\$318 \$405	\$331 \$419	\$345 \$436	\$359 \$452	\$375 \$470	18 18	21.75 21.75	35 35	14.75 14.75	17.5 17.5	22 22	.875 .875

Specify Maple or Oak wood.

Full extended backrest models '503' and '103' available without decorative side brace, specify when ordering.

Footrail channel on stool models standard in Brass. Specify in 'SSC' Stainless Steel. *No upcharge.*

Nail trim with upholstered seat pad on 'US' models, specify 'BNT' Brass, 'ANT' Antique, 'SNT' Stainless, or 'ONT' Oxford. *Add \$20 list per chair; fabric requirement .5 yds.*

Front leg casters available on chair models, specify 'CA'. *Add \$40 list per chair.*

Arc top rail with moderate slope available, specify '103', '104', '105', and '107' models when ordering.





Arc top rail with elevated slope available, specify '1107', '1103', and '1101' models when ordering.

Decorative cutout available on arc tops, specify 'C'. *Add \$20 list per chair.*

Motion seats available, specify '102' model when ordering.

# WALTON EAST

Product information on page 78.

Model Number	PRICE							SPECIFICATIONS							
	All Wood	Fabric COM/200	Fabric Grade 300	Fabric Grade 400	Fabric Grade 500	Fabric Grade 600	Fabric Grade 700	Width	Depth	Height	Seat Depth	Seat Height	Arm Height	Weight (lbs.)	Fabric (yds.)
502 502US 102 102US		\$405						18	22	33-36	14.75	16-19		50	
		\$468	\$479	\$490	\$503	\$515	\$528	18	22	33-36	14.75	16-19		50	.625
		\$405						18	22	33-36	14.75	16-19		50	
		\$468	\$479	\$490	\$503	\$515	\$528	18	22	33-36	14.75	16-19		50	.625
500 500US 100 100US		\$487						23	23	33-36	15.75	16-19	24-27	61	
		\$573	\$587	\$602	\$618	\$634	\$652	23	23	33-36	15.75	16-19	24-27	61	.875
		\$487						23	23	33-36	15.75	16-19	24-27	61	
		\$551	\$562	\$573	\$584	\$595	\$608	23	23	33-36	15.75	16-19	24-27	61	.875
503-RTA 103-RTA		\$343						22	30	35	14.75	17.5	28	32	
		\$343						22	30	35	14.75	17.5	28	32	
508-16 508US-16 108-16 108US-16		\$264						16.5	19	31	13.5	16		18	
		\$291	\$304	\$317	\$331	\$345	\$361	16.5	19	31	13.5	16		18	.625
		\$264						16.5	19	31	13.5	16		18	
		\$291	\$304	\$317	\$331	\$345	\$361	16.5	19	31	13.5	16		18	.625
508-14 508US-14 108-14 108US-14		\$264						16.5	19	29	13.5	14		18	
		\$291	\$304	\$317	\$331	\$345	\$361	16.5	19	29	13.5	14		18	.625
		\$264						16.5	19	29	13.5	14		18	
		\$291	\$304	\$317	\$331	\$345	\$361	16.5	19	29	13.5	14		18	.625

Specify Maple or Oak wood.

Models '503' and '103' available without decorative side brace, specify when ordering.

Nail trim with upholstered seat pad on 'US' models, specify 'BNT' Brass, 'ANT' Antique, 'SNT' Stainless, or 'ONT' Oxford. Add \$20 list per chair; fabric requirement .5 yds.

Arc top rail available, specify, '100', '102', '103', and '108' models when ordering.

Decorative cutout available on '100', '102', '103', and '108' models, specify 'C'. Add \$20 list per chair.

Jury base with self-return available on 502, 102, 500, and 100 models, specify 'JURY BASE'. Add \$120 list per chair.

# WALTON

Product information on page 99.









Model Number	PRICE							SPECIFICATIONS							
	All Wood	Fabric COM/200	Fabric Grade 300	Fabric Grade 400	Fabric Grade 500	Fabric Grade 600	Fabric Grade 700	Width	Depth	Height	Seat Depth	Seat Height	Arm Height	Weight (lbs.)	Fabric (yds.)
509-2 509US-2		\$1728						56	22.25	35	17	18	25.75	62	
		\$1778	\$1812	\$1844	\$1880	\$1916	\$1954	56	22.25	35	17	18	25.75	62	1.875
509-3 509US-3		\$1947						71.5	22.25	35	17	18	25.75	82	
		\$2004	\$2047	\$2087	\$2131	\$2177	\$2225	71.5	22.25	35	17	18	25.75	82	2.25

Specify Maple or Oak wood.



# WALTON WEST

Product information on page 80.

Model Number	PRICE							SPECIFICATIONS								
	All Wood	Fabric COM/200	Fabric Grade 300	Fabric Grade 400	Fabric Grade 500	Fabric Grade 600	Fabric Grade 700	Width	Depth	Height	Seat Depth	Seat Height	Arm Height	Weight (lbs.)	Fabric (yds.)	
53-18 53US-18		\$308						18.25	21.25	34.75	15.5	17.5		23		
		\$340	\$353	\$365	\$381	\$395	\$411	18.25	21.25	34.75	15.5	17.5		23	.75	
51 51US		\$391						23.5	23	35	15.75	17.5	26	28		
		\$461	\$476	\$490	\$508	\$524	\$542	23.5	23	35	15.75	17.5	26	28	.875	
53-BS-24 53-BS-30 53US-BS-24 53US-BS-30		\$379						18.25	20.75	36.5	16	24		29		
		\$379						18.25	20.75	43.5	16	30		29		
		\$411	\$424	\$436	\$452	\$466	\$482	18.25	20.75	36.5	16	24		29		
		\$411	\$424	\$436	\$452	\$466	\$482	18.25	20.75	43.5	16	30		29	.75	
57-18 57US-18		\$308						18.75	21.25	34.75	15.5	17.5		23		
		\$340	\$353	\$365	\$381	\$395	\$411	18.75	21.25	34.75	15.5	17.5		23	.75	
57-BS-24 57-BS-30 57US-BS-24 57US-BS-30		\$379						18.25	20.75	36.5	16	24		29		
		\$379						18.25	20.75	43.5	16	30		29		
		\$411	\$424	\$436	\$452	\$466	\$482	18.25	20.75	36.5	16	24		29	.75	
		\$411	\$424	\$436	\$452	\$466	\$482	18.25	20.75	43.5	16	30		29	.75	
507UB 507UBS			\$358	\$368	\$378	\$388	\$398	\$410	18	21.75	35	14.75	17.5		24	.5
			\$393	\$417	\$438	\$464	\$488	\$515	18	21.75	35	14.75	17.5		24	.75
506US 506UBS			\$438	\$448	\$457	\$467	\$478	\$488	23.5	23	35	15.75	17.5	26	30	.75
			\$475	\$501	\$525	\$552	\$579	\$608	23.5	23	35	15.75	17.5	26	30	.875
507UB-BS-24 507UB-BS-30 507UBS-BS-24 507UBS-BS-30			\$441	\$450	\$458	\$468	\$478	\$487	18	21.25	36.5	14.75	24		30	.5
			\$441	\$450	\$458	\$468	\$478	\$487	18	21.25	43.5	14.75	30		30	.5
			\$478	\$500	\$521	\$545	\$570	\$595	18	21.25	36.5	14.75	24		30	.75
			\$478	\$500	\$521	\$545	\$570	\$595	18	21.25	43.5	14.75	30		30	.75

Specify Maple or Oak wood.

Footrail channel on stool models standard in Brass. Specify in 'SSC' Stainless Steel. *No upcharge.*

Nail trim with upholstered seat pad on 'US' models, specify 'BNT' Brass, 'ANT' Antique, 'SNT' Stainless, or 'ONT' Oxford. *Add \$20 list per chair; fabric requirement .5 yds.*

Decorative cutout available, specify 'C'. *Add \$20 list per chair.*



Front leg casters available on chair models, specify 'CA'. *Add \$40 list per chair.*

# WARREN

Product information on page 82.

## PRICE

## SPECIFICATIONS

Model Number	All Wood	Fabric COM/200	Fabric Grade 300	Fabric Grade 400	Fabric Grade 500	Fabric Grade 600	Fabric Grade 700	Width	Depth	Height	Seat Depth	Seat Height	Arm Height	Weight (lbs.)	Fabric (yds.)
118 118US		\$158	\$213	\$225	\$236	\$248	\$261	\$274	13 13	13 13	18 18			12 12	.75
124 124US		\$167	\$221	\$233	\$243	\$255	\$269	\$281	14.5 14.5	14.5 14.5	24 24			14 14	.75
130 130US		\$192	\$244	\$255	\$267	\$279	\$291	\$308	16.25 16.25	16.25 16.25	30 30			16 16	.75

Specify in Maple or Oak wood.

Motion seats available on all models, specify 'MO'. Add \$42 list per stool.



Multi-finish on seat and frame. Add \$25 list per chair.

Personalized laser engraving on seats. Add \$100 list set up charge and \$50 list per chair.

Personalized stamping on seats. Add \$100 set up charge and \$50 list per chair.

# WYLIE

Product information on page 83.

Model Number	PRICE							SPECIFICATIONS							
	All Wood	Fabric COM/200	Fabric Grade 300	Fabric Grade 400	Fabric Grade 500	Fabric Grade 600	Fabric Grade 700	Width	Depth	Height	Seat Depth	Seat Height	Arm Height	Weight (lbs.)	Fabric (yds.)
S-9556-18 S-9556US-18		\$375								18					
		\$461	\$472	\$483	\$494	\$506	\$519	16.25	16.75	18				20	1.625
S-9556-24 S-9556-30 S-9556US-24 S-9556US-30		\$375						16.25	16.75	24				21	
		\$375						16.25	16.75	30				22	
		\$461	\$472	\$483	\$494	\$506	\$519	16.25	16.75	24				21	1.625
		\$461	\$472	\$483	\$494	\$506	\$519	16.25	16.75	30				22	1.625

Specify in Maple or Oak wood.







Footrail ring on stool models standard in Brass. Specify in 'SSR' Stainless Steel or 'BLR' Black. *No upcharge.*

Personalized laser engraving on seats. *Add \$100 list set up charge and \$50 list per chair.*

Personalized stamping on seats. *Add \$100 set up charge and \$50 list per chair.*

# TABLES COLLABORATION

Product information on page 104.

Model Number		PRICE				SPECIFICATIONS							
		HPL 'S' Self Edge	PVC '3P' Edge	WOOD 'A'- 'E' Edge	WOOD 'F' & 'G' Edge	Width	Depth	Height				Weight (lbs.)	
L-3636P29		\$650	\$650	\$714	\$751	36	36	29					70
L-4242P29		\$781	\$781	\$846	\$871	42	42	29					80
L-4848P29		\$900	\$900	\$976	\$1028	48	48	29					90
L-3042P29		\$644	\$644	\$709	\$749	30	42	29					60
L-3060P29		\$706	\$706	\$788	\$842	30	60	29					95
L-3660P29		\$780	\$780	\$857	\$908	36	60	29					105
L-3672P29		\$890	\$890	\$982	\$1036	36	72	29					125
L-4260P29		\$1014	\$1014	\$1095	\$1154	42	60	29					132
L-4272P29		\$1139	\$1139	\$1228	\$1285	42	72	29					140
L-4284P29		\$1314	\$1314	\$1354	\$1421	42	84	29					150
L-36RP29		\$683	\$683	\$846	\$874	36		29					42
L-42RP29		\$703	\$703	\$871	\$901	42		29					80
L-48RP29		\$894	\$894	\$1024	\$1065	48		29					95
L-3636P27 / L-3636P25		\$650	\$650	\$714	\$751	36	36	27/25					70
L-4242P27 / L-4242P25		\$781	\$781	\$846	\$871	42	42	27/25					80
L-4848P27 / L-4848P25		\$900	\$900	\$976	\$1028	48	48	27/25					90
L-3042P27 / L-3042P25		\$644	\$644	\$709	\$749	30	42	27/25					60
L-3060P27 / L-3060P25		\$706	\$706	\$788	\$842	30	60	27/25					95
L-3660P27 / L-3660P25		\$780	\$780	\$857	\$908	36	60	27/25					105
L-3672P27 / L-3672P25		\$890	\$890	\$982	\$1036	36	72	27/25					125
L-4260P27 / L-4260P25		\$1014	\$1014	\$1095	\$1154	42	60	27/25					132
L-4272P27 / L-4272P25		\$1139	\$1139	\$1228	\$1285	42	72	27/25					140
L-4284P27 / L-4284P25		\$1314	\$1314	\$1354	\$1421	42	84	27/25					150
L-36RP27 / L-36RP25		\$683	\$683	\$846	\$874	36		27/25					42
L-42RP27 / L-42RP25		\$703	\$703	\$871	\$901	42		27/25					80
L-48RP27 / L-48RP25		\$894	\$894	\$1024	\$1065	48		27/25					95

Specify Maple or Oak wood.

Specify laminate top. See page 178 for selections. *No upcharge.*

Select COM laminate top. *Add \$125 list per table.*

Minimum order quantity. *Add \$80 list per table for quantities less than three per order.*

Specify leg: 'S' Square or 'T' Tapered.









Specify edge: Wood 'A' Square, 'B' Bullnose, 'C' Traditional, 'D' Thumbnail, 'E' Bevel, 'F' Knife, 'G' Reverse Knife; 'S' HPL Self; '3P-462' PVC Slate, '3P-485' PVC Espresso, '3P-425' PVC Taupe, '3P-460' PVC Gray, '3P-420' PVC Beige.

# TABLES MULTI-FUNCTIONAL

Product information on page 106.

## PRICE

## SPECIFICATIONS

Model Number	HPL 'S' Self Edge	PVC '3P' Edge	PVC Wood Edge	WOOD Wood Edge	+	CROSS Base		Width	Depth	Width	Width	Height	Weight (lbs.)	Weight (lbs.)	Weight (lbs.)
								Top	Top	Base	Column	Base	Top	Base	Total
H-2424-29 & MB-2222		\$123	\$123	\$145	\$193	\$90		24	24	22	3	28.5	18	14	32
H-3030-29 & MB-2222		\$168	\$168	\$202	\$291	\$90		30	30	22	3	28.5	29	14	43
H-3636-29 & MB-3030		\$215	\$215	\$259	\$347	\$108		36	36	30	3	28.5	41	24	65
H-4242-29 & MB-3636		\$335	\$335	\$405	\$484	\$212		42	42	36	4	28.5	56	42	98
H-4848-29 & MB-3636		\$343	\$343	\$415	\$543	\$212		48	48	36	4	28.5	70	42	112
H-2430-29 & MB-2222		\$145	\$145	\$173	\$236	\$90		24	30	22	3	28.5	23	14	37
H-2436-29 & MB-2230		\$163	\$163	\$190	\$252	\$105		24	36	30	3	28.5	27	24	51
H-3036-29 & MB-2230		\$182	\$182	\$219	\$298	\$105		30	36	30	3	28.5	34	24	58
H-3048-29 & MB-2230		\$234	\$234	\$281	\$365	\$105		30	48	30	3	28.5	45	24	69
H-24R-29 & MB-2222		\$165	\$165	\$202	\$254	\$90		24		22	3	28.5	18	14	32
H-30R-29 & MB-2222		\$205	\$205	\$248	\$357	\$90		30		22	3	28.5	29	14	43
H-36R-29 & MB-3030		\$274	\$274	\$331	\$510	\$108		36		30	3	28.5	41	24	65
H-42R-29 & MB-3636		\$440	\$440	\$527	\$639	\$212		42		36	4	28.5	56	42	98
H-48R-29 & MB-3636		\$474	\$474	\$565	\$685	\$212		48		36	4	28.5	72	42	114
Model Number	HPL Self Edge	PVC '3P' Edge	PVC Wood Edge	WOOD Wood Edge	+	CIRCLE Base		Width	Depth	Width	Width	Height	Weight (lbs.)	Weight (lbs.)	Weight (lbs.)
								Top	Top	Base	Column	Base	Top	Base	Total
H-2424-29 & MB-18RD		\$123	\$123	\$145	\$193	\$130		24	24	18	3	29.12	18	34	52
H-3030-29 & MB-18RD		\$168	\$168	\$202	\$291	\$130		30	30	18	3	29.12	29	34	63
H-3636-29 & MB-22RD		\$215	\$215	\$259	\$347	\$175		36	36	22	3	29.12	41	38	79
H-4242-29 & MB-28RD		\$335	\$335	\$405	\$484	\$320		42	42	28	4	29.12	56	24	80
H-4848-29 & MB-28RD		\$343	\$343	\$415	\$543	\$320		48	48	28	4	29.12	70	24	94
H-2430-29 & MB-18RD		\$145	\$145	\$173	\$236	\$130		24	30	18	3	29.12	23	34	57
H-2436-29 & MB-22RD		\$163	\$163	\$190	\$252	\$175		24	36	22	3	29.12	27	38	65
H-3036-29 & MB-22RD		\$182	\$182	\$219	\$298	\$175		30	36	22	3	29.12	34	38	72
H-24R-29 & MB-18RD		\$165	\$165	\$202	\$254	\$130		24		18	3	29.12	18	34	52
H-30R-29 & MB-18RD		\$205	\$205	\$248	\$357	\$130		30		18	3	29.12	29	34	63
H-36R-29 & MB-22RD		\$274	\$274	\$331	\$510	\$175		36		22	3	29.12	41	38	79
H-42R-29 & MB-28RD		\$440	\$440	\$527	\$639	\$320		42		28	4	29.12	56	44	100
H-48R-29 & MB-28RD		\$474	\$474	\$565	\$685	\$320		48		28	4	29.12	72	44	116
Requires Two Bases		\$234	\$234	\$281	\$365	\$260		30	48	22	3	29.12	45	68	113
H-3048-29 & MB-18RD		\$328	\$328	\$397	\$510	\$350		36	60	22	3	29.12	68	76	144
H-3672-29 & MB-22RD		\$372	\$372	\$452	\$602	\$350		36	72	22	3	29.12	81	76	144
Model Number	HPL Self Edge	PVC '3P' Edge	PVC Wood Edge	WOOD Wood Edge	+	T-LEG Base		Width	Depth	Width	Width	Height	Weight (lbs.)	Weight (lbs.)	Weight (lbs.)
								Top	Top	Base	Column	Base	Top	Base	Total
Requires Two Bases		\$234	\$234	\$281	\$365	\$240		30	48	22	3	28.5	45	56	101
H-3048P29 & MB-522		\$328	\$328	\$397	\$510	\$240		36	60	22	3	28.5	68	56	124
H-3672P29 & MB-522		\$372	\$372	\$452	\$602	\$240		36	72	22	3	28.5	81	56	137

Specify laminate top. See page 178 for selections. *No upcharge.*

Select COM laminate top. *Add \$125 list per table.*

Bar height can be specified on all tables, specify 'BH' when ordering. *Add \$62 list per table.*

Minimum order quantity. *Add \$80 list per table for quantities less than three per order.*

Specify edge: Wood 'A' Square, 'B' Bullnose, 'C' Traditional, 'D' Thumbnail, 'E' Bevel; 'S' HPL Self; '3W' 3MM Wood; or '3P-462' PVC Slate, '3P-485' PVC Espresso, '3P-425' PVC Taupe, '3P-460' PVC Gray, '3P-420' PVC Beige.



# DETAILS & MATERIALS



# WOOD FINISHES & LAMINATES

## OAK



### NATURAL NOO

Laminate Match  
Formica 7152-58 Northern Oak



### SOLAR SOO

Laminate Match  
Formica 346-58 Natural Oak



### LIGHT LOO

Customer Choice Laminate



### AUTUMN AOO

Laminate Match  
Wilsonart 7816-60 Solar Oak



### GREY GOO

Customer Choice Laminate



### PECAN POO

Laminate Match  
Pionite W0581 Wisconsin Oak

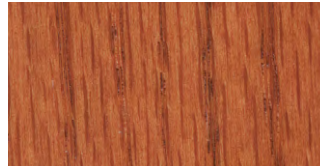

### MEDIUM CHERRY MCO

Laminate Match  
Nevamar WC5581N Blossom

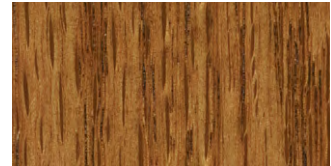

### MEDIUM WALNUT MWO

Laminate Match  
Wilsonart 7885K-78 English Oak



### ENGLISH EOO

Laminate Match  
Wilsonart 7957K-78 Zanzibar

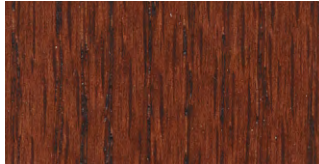

### WINDSOR MAHOGANY WMO

Laminate Match  
Formica 7583-58 Victorian

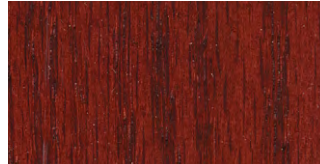

### CHERRY CHO

Customer Choice Laminate

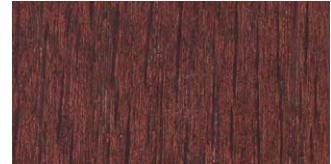

### CORDOVAN COO

Customer Choice Laminate

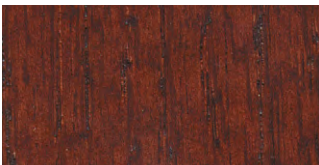

### MAHOGANY MAO

Laminate Match  
Wilsonart 7040K-78 Figured

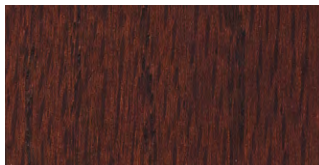

### IMITATION WALNUT IWO

Laminate Match  
Formica 6209-43 Prestige Walnut

### STANDARD FINISH

Our standard wood finishes are represented. These printed samples closely represent our standard colors. Please contact Customer Service for actual wood finish samples.

### CUSTOM FINISHES

We will make every effort to accurately match your custom finish sample. Please contact Customer Service for a custom finish match as there may be additional manufacturing charges to be added to the standard development fee of \$100 net per match. Due to limitations of some wood species, we reserve the right to decline requests. Wood owes its inherent beauty to variations in color, graining, and texture

in its natural state. In our finishing process, we attempt to accent this beauty rather than subdue it. Consequently, the chairs you receive may not be a perfect color match to a sample. Similarly, there may be minor variations in color from one chair to the next even though they are finished at the same time.

### HIGH PRESSURE LAMINATES (HPL'S)

Jasper Chair's table collections feature HPL top options. Reference the swatches for a complementary HPL match. For critical or specific color representation, contact Customer Service for an actual HPL sample.



## MAPLE



**NATURAL NMM**

Laminate Match  
Wilsonart 7909-60 Fusion Maple



**SPICE SMM**

Laminate Match  
Formica 7284-58 Figured Annigre



**MEDIUM CHERRY MCM**

Laminate Match  
Formica 5904-43 Wild Cherry



**MEDIUM WALNUT MWM**

Customer Choice Laminate

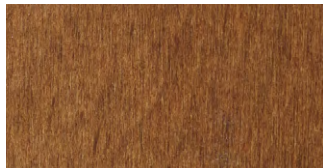

**NUTMEG NUM**

Laminate Match  
Pionite WC331-H Victorian Cherry

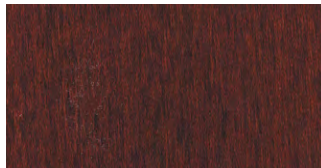

**MAHOGANY MAM**

Laminate Match  
Wilsonart 7122K-07 Empire

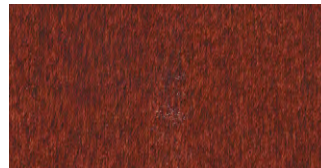

**CHERRY CHM**

Customer Choice Laminate

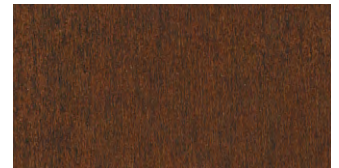

**IMITATION WALNUT IWM**

Laminate Match  
Wilsonart 7942K-07 Columbian

## COLOR

(ADD \$20 LIST PER ITEM)



**LEMON LEO**

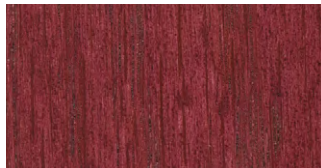

**GRAPE GRO**

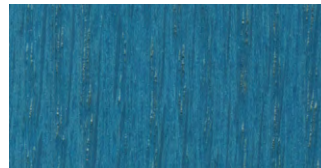

**SKY BLUE SBO**



**FLAME RED FRO**

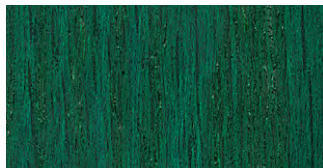

**EMERALD EMO**

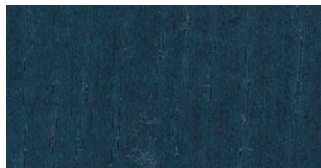

**DARK BLUE DBO**

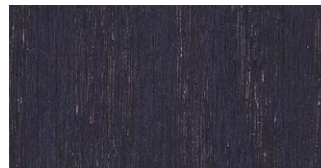

**VIOLET VIO**

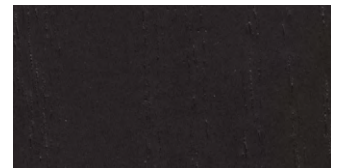

**EBONY EBO**

# FABRIC PROGRAM

Jasper Chair's Fabric Program offers a selection of fabrics in a wide array of patterns and colors to accommodate a variety of applications. From durable fabrics to withstand the rigors of schools and universities, to easy-to-clean fabrics for restaurant and hospitality use, to protective upholsteries suitable for healthcare, Jasper Chair will have upholstery to fit the need.

A variety of fabrics are shown on Jasper Chair's swatch cards. Larger memo samples are available by contacting the fabric manufacturer direct.

All product includes the cost of applied fabric using Jasper Chair's Fabric Program and grade structure. These fabrics are classified or priced in grades ranging from grade 200 (lowest) to grade 700 (highest). If two graded fabrics are to be applied to the same frame, pricing will be based on the higher of the two grades.

Published yardage is based on a solid 54" wide fabric. In some cases, the pattern or repeat will require additional yardage. Please contact Customer Service to help estimate yardage requirements, toll free: 866-891-8289.

Unless the customer indicates, all fabrics will be customarily applied in a railroad manner (or off the roll in a horizontal fashion) as shown.

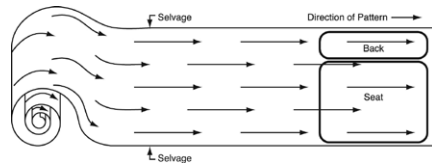

If the fabric should be applied in a different manner or up the roll, please indicate on your purchase order. Please be aware that additional costs and additional yardage may arise from applying the fabric other than the customary direction.

Cut yardage is available for purchase. Should a customer require to purchase cut yardage, refer to the following table for pricing.

- Grade 200, \$77 per yard list
- Grade 300, \$113 per yard list
- Grade 400, \$147 per yard list
- Grade 500, \$186 per yard list
- Grade 600, \$225 per yard list
- Grade 700, \$266 per yard list

Jasper Chair partners with multiple upholstery vendors to offer graded-in fabrics for ordering ease. These are listed on the following pages. For more information and to order memo samples please contact vendors direct.

ARC COM  
arc-com.com  
800-223-5466

CF STINSON  
cfstinson.com  
800-841-6279

DOUGLAS  
douglassfabrics.com  
800-950-3684

MAYER  
mayerfabrics.com  
800-428-4415

BURCH  
birchfabrics.com  
800-841-8111

CAMIRA  
camirafabrics.com  
616-288-0655

MAHARAM  
maharam.com  
800-645-3943

MOMENTUM  
themomgroup.com  
800-366-6839

## FIRE RETARDANCY

All Jasper Chair products are manufactured to comply with California TB 117 as a minimum standard. Compliance with more stringent codes requires special manufacturing considerations and possible up-charges.

For California TB 133 we use either barrier material between the fire retardant fabric and foam cushioning or a fire retardant fabric and foam in order to comply with California TB 133. Some product designs and fabrics cannot be combined to comply with California TB 133. Because of this, we reserve the right to reject any request for a fabric, including C.O.M., or product style that may compromise the integrity or safety of a product specified to comply with California TB 133. Please contact Customer Service for pricing and availability to comply with California TB 133.

## STANDARD LEATHER

The leathers shown are thicker material selected for woven backrests; they are not ideal for standard upholstery application.

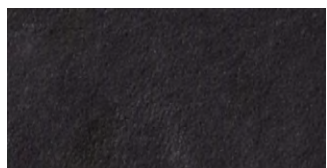

BLACK BL

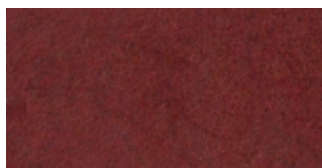

BURGUNDY BU



BROWN BR



TAN TA

## CUSTOMER'S OWN MATERIAL

Jasper Chair accommodates Customer's Own Material (COM) requests. COM orders must meet quantity requirements for adequate yardage as well as performance requirements to avoid wear and defects and satisfy aesthetic expectations on Jasper Chair products.

When selecting a fabric please be aware that some fabrics may not tailor well due to their characteristics. Jasper Chair cannot assume responsibility for the tailoring quality of some fabrics or for the receipt of defective materials.

When specifying COM, refer to Grade 200/COM pricing grades.

All COM orders must be accompanied by Jasper Chair's COM form to expedite the order, indicating fabric details and application instruction. All COM orders should be shipped to:

Jasper Chair  
Receiving Department  
534 East 8th Street  
Jasper, Indiana 47547

Yardage published is based on a solid 54" wide fabric. In some cases, the COM pattern or textile width will require additional yardage. Please contact our Customer Service to help estimate yardage requirements, toll free: 866-891-8289.

Unless otherwise noted, all fabrics will be applied in a railroad manner (or off the roll in a horizontal fashion) as shown. It is very important for the customer to indicate upholstery preferences on the COM form to achieve the desired look when submitting a COM order. Please be aware that additional costs and additional yardage may arise from applying the fabric other than the customary direction.

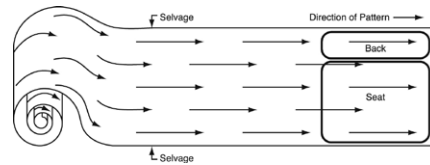

Listed yardage requirements are based on 54" wide fabric. For fabrics less than 54" wide, or those requiring matched upholstery such as large patterns, prints, stripes, etc., additional yardage will be required based on style and quantity ordered. The below chart is a general guide to estimating yardage:

Fabric width	Plain	Under 7" repeat	7"-13" repeat	14"-21" repeat	22"-27" repeat	27"+ repeat
54"	0	15%	20%	25%	30%	40%
51"-53"	10%	25%	30%	35%	40%	50%
48"-50"	15%	30%	35%	40%	45%	55%
45"-47"	30%	45%	50%	55%	60%	70%
36"-44"	50%	65%	70%	75%	80%	90%

## COM FORM

All COM orders must be accompanied by Jasper Chair's COM form to expedite the order, indicating fabric details and application instruction. All COM orders ship to:

Jasper Chair  
Receiving Department  
534 East 8th Street  
Jasper, Indiana 47547

Customer Name

---

Purchase Order Number

---

Address

---

City, State, Zip

---

Fabric Manufacturer

---

Fabric Pattern Name / Color Name

---

Pattern Instructions (indicate which direction the fabric is to be applied). Circle one:



Off the roll, railroaded



Up the roll

Comments / Notes

---

# FABRIC PROGRAM

Fabrics listed may have been discontinued or price changed since publishing.

## ARC COM

Allegra.....500	Galaxy.....600	Ombre Petal.....600	Top Notch.....Call
Alpha.....500	Gamma.....400	Omega.....500	Tritik.....600
Analog.....600	Gardenia.....400	Orion.....500	Uptown.....700
Apex.....600	Gatsby.....400	Pala.....Call	Urban.....600
Arashi.....600	Gem.....400	Palatine.....500	Vault.....500
Astral.....600	Geostitch.....600	Palatine 2.....500	Velocity.....600
Atomic.....600	Gianni.....600	Panache.....500	Vineyard.....500
Aurora.....500	Glam.....400	Pebble Beach.....400	Vivo.....500
Axis.....600	Glo.....500	Plateau.....400	Volt.....Call
Bali.....700	Great Wall.....600	Polished.....500	Windlass.....700
Block Party.....700	Grid.....600	Polo.....600	Yo-Yo.....600
Block Petal.....600	Hanji.....600	Posh.....600	Zipline.....600
Blossom.....600	Harlequin.....600	Prism.....300	
Boardwalk.....400	Highlands.....600	Provence.....Call	
Bounce.....600	Hush.....500	Radius.....600	
Brayer Flower.....600	Illusion.....300	Raya.....500	
Bronco.....500	Illusion 2.....300	Ringling.....600	
Bubbly.....600	Intaglio.....500	Riviera.....700	
Burkina.....600	Intaglio 2.....500	Robotic.....600	
Campus Stripe.....500	Intersect.....500	Rodeo.....300	
Candy Land.....600	Isabella.....400	Rodeo 2.....300	
Carnival.....500	Itajime.....600	Rogue.....500	
Casablanca.....600	Jardin.....600	Roundabout.....400	
Cascade.....600	Jing.....500	Sagrada.....700	
Cassio.....500	Jive.....500	Sahara.....500	
Cavo.....600	Kaolin.....500	Samba.....600	
Centring Stripe.....600	Kassena.....500	Santa Fe.....600	
Channel.....500	Katano.....500	Santorini.....600	
Chit-Chat.....400	Key.....500	Saxon.....600	
Chroma.....400	Kimono.....500	Sea Willow.....600	
Cirque.....600	Kinetic.....600	Sector.....600	
Clarion.....600	Kirigami.....500	Sequoia.....500	
Coastline.....500	Kuba.....600	Sherlock.....400	
Column.....500	Kumo.....600	Sherlock 2.....400	
Compass.....600	Laurel.....600	Shibori.....600	
Constantine.....700	Legacy.....500	Shift.....600	
Contour.....400	Legend.....500	Shimmer.....400	
Cosmos.....400	Linea.....500	Shimmer 2.....400	
Crescendo.....600	Loara.....600	Silverado.....400	
Crossroads.....500	Lore.....600	Silverado 2.....400	
Crystal.....400	Lunette.....700	Solitude.....600	
Cutting Edge.....Call	Luxe.....500	Sonata Stripe.....600	
Dakota.....400	Lyre.....400	Spectrum.....400	
Dakota 2.....400	Lyric.....600	Speedway.....600	
Daytona.....600	Majorca.....600	Spin.....600	
Dazzle.....Call	Marathon.....500	Spinnaker.....600	
Delphi.....400	Marquee.....600	Spirit.....400	
Delta.....400	Mason.....600	Spring.....600	
Durango.....300	Mason Stripe.....600	Spot-On.....600	
Dynasty.....500	Meadow.....600	Spyro.....600	
Eclipse.....500	Mesa.....500	Square One.....700	
Elementary.....700	Mirror, Mirror.....500	Staccato.....600	
Elevado.....500	Moon Beam.....600	Strata.....400	
Empress.....400	Moon Beam 2.....600	Streamline.....400	
Etch.....400	Morocco.....600	Sukhala.....600	
Facet.....600	Mystique.....500	Sundial.....600	
Fiji.....500	Nahouri.....600	Symphony.....600	
Fiore.....600	Navigator.....600	Sync.....500	
Fireflies.....400	Network.....Call	Tally.....400	
Fragment.....700	Niagara.....600	Tectonic.....400	
Francesca Wool.....Call	Nova.....600	The Plaid.....Call	
Francesca Wool II.....700	Oculus.....500	Theory.....300	
Frontier.....300	Odyssey.....500	Tiebele.....600	

BURCH

Abstract.....	400	Encore.....	400	Nautica.....	400	Stamp.....	300	Index.....	400
Access.....	400	Entwine.....	300	Nimbus.....	500	Stanza.....	300	Jive.....	400
Adorn.....	300	Escape.....	300	Nirvana.....	300	Stencil.....	500	Journal.....	400
Alias.....	400	Essay.....	400	Nonstop.....	400	Stride.....	300	Kosta.....	400
Align.....	300	Essence.....	400	Occasion.....	300	Structure.....	300	Link.....	400
Amenity.....	400	Evolve.....	300	Optic.....	500	Study.....	400	Memoir.....	400
Amplify.....	500	Excursion.....	400	Opus.....	400	Suite.....	400	Odyssey.....	300
Analog.....	400	Exhibit.....	500	Orbit.....	300	Summit.....	400	Parker.....	300
Annex.....	400	Fast Track.....	300	Origami.....	500	Surge.....	300	Patina.....	400
Anthem.....	400	Feature.....	400	Outline.....	400	Surplus.....	500	Salinger.....	400
Apex.....	400	Felt.....	400	Ozone.....	300	Switchback.....	500	Script.....	400
Applause.....	300	Fiction.....	400	Palette.....	400	Syllabus.....	400	Tech.....	400
Badge.....	300	Filter.....	400	Parallel.....	300	Sync.....	400	Talsory.....	400
Barcode.....	400	Firewall.....	400	Passage.....	400	Tabloid.....	400	Twain.....	400
Basis.....	200	First Class.....	400	Pathway.....	400	Tagline.....	400	Verve.....	300
Beeline.....	300	Flannel.....	400	Peace.....	300	Tangle.....	300	Wilde.....	400
Bespoke.....	500	Fleece.....	400	Peak.....	400	Tempo.....	300		
Beta.....	400	Flint.....	200	Pigment.....	400	Tether.....	300	VINYL	
Blade.....	300	Flora.....	300	Piñata.....	500	Theory.....	200	Accord.....	300
Block Party.....	300	Focal Point.....	300	Pindot.....	300	Thrive.....	300	Alchemy.....	300
Bloom.....	500	Folio.....	400	Plaza.....	400	Tint.....	400	All American.....	200
Blur.....	500	Formation.....	200	Pleat.....	400	Toggle.....	400	Allante.....	200
Boutique.....	400	Freeze Fram.....	400	Plush.....	400	Tower.....	400	Allante Touch.....	300
Box Office.....	300	Frenzy.....	300	Portfolio.....	400	Trek.....	400	Allegro.....	200
Branch Out.....	300	Fusion.....	400	Portrait.....	400	Triad.....	300	Alloy.....	300
Breeze.....	300	Generation.....	300	Prestige.....	400	Trilogy.....	400	Allure.....	300
Brink.....	400	Glamour.....	400	Principle.....	200	Tumble.....	300	Artic.....	300
Brush Stroke.....	400	Graph.....	400	Profile.....	200	Turnaround.....	300	Bandwidth.....	300
Bungalow.....	300	Grove.....	300	Proof.....	300	Tweed.....	400	Berwick Tweed.....	300
Buzzword.....	300	Guru.....	300	Propel.....	500	Upstream.....	500	Bondi.....	200
Candid.....	400	Headline.....	300	Prototype.....	400	Uptown.....	400	Bottega.....	300
Canteen.....	500	Hearth.....	300	Puzzle.....	300	Utopia.....	500	Bourbon Street.....	300
Caption.....	300	Homestead.....	400	Quadrant.....	300	Valet.....	400	Bramble.....	300
Carnival.....	300	Hue.....	400	Quantum.....	500	Velour.....	400	Bronte.....	200
Chalet.....	300	Hybrid.....	300	Quest.....	300	Verge.....	400	Burkshire.....	300
Chime.....	300	Ignite.....	500	Radiant.....	400	Viewpoint.....	400	Canyon.....	200
Chord.....	300	Imperial.....	400	Ratio.....	400	Villa.....	300	Carrara.....	300
Chorus.....	400	Infinity.....	400	Reed.....	500	Vine.....	300	Casablanca.....	300
Chroma.....	400	Insignia.....	400	Regis.....	400	Virtual.....	400	Celebration.....	400
Chronicle.....	400	Ion.....	400	Reserve.....	400	Voyage.....	300	Centerpoint.....	500
Circa.....	300	Jamboree.....	300	Retreat.....	300	Waldorf.....	400	Chambray.....	300
Cityscape.....	500	Jitterbug.....	400	Ricochet.....	400	Watercolor.....	500	Chamea II.....	300
Column.....	300	Junction.....	400	Riddle.....	500	Windsor.....	400	Classic.....	300
Connection.....	400	Key.....	300	Rise.....	300	Woolen.....	500	Clique.....	300
Cottage.....	400	Lattice.....	300	Roam.....	300	Zest.....	300	Clutch.....	400
Course.....	400	Launch.....	300	Roundabout.....	400	Zoom.....	400	Colorguard.....	300
Cove.....	400	Limelight.....	300	Runway.....	500			Connect.....	200
Crisscross.....	500	Linen.....	400	Rush hour.....	400	POLYURETHANE		Contempora.....	200
Crystal Ball.....	400	Livewire.....	300	Savy.....	300	Aura.....	400	Cornerstone.....	300
Curio.....	500	Lyric.....	300	Scale.....	400	Ballistic.....	400	Crosshatch.....	300
Cutting Edge.....	300	Mandalay.....	500	Scout.....	300	Baron.....	400	Dimension (Nassimi).....	400
Dapper.....	300	Meander.....	500	Scramble.....	300	Beckett.....	400	Disco.....	300
Davenport.....	400	Megabyte.....	400	Segment.....	300	Capote.....	400	Ditto.....	400
Decade.....	300	Melody.....	400	Shibori.....	500	Clarke.....	400	Dolphin.....	200
Degree.....	400	Method.....	200	Shuffle.....	400	Cork.....	400	Enchanted.....	300
Demo.....	400	Metric.....	200	Sidestep.....	500	Element.....	400	Endurance.....	300
Digital.....	400	Microchip.....	400	Social.....	300	Elite.....	300	English Pub.....	300
Draft.....	300	Milano.....	400	Sonic.....	300	Equator.....	400	Engrave.....	400
Drama.....	300	Milestone.....	300	Spellbound.....	400	Fable.....	400	Espirit.....	200
Drift.....	300	Mission.....	300	Spotlight.....	300	Flicker.....	400	Expressions.....	300
Edit.....	300	Mixtape.....	400	Sprint.....	300	Footnote.....	400	Flare.....	400
Elevate.....	500	Motley.....	600	Sprout.....	300	Hemingway.....	400	Focus.....	400
Embellish.....	300	Motto.....	400	Stage.....	300	Huxley.....	400	Fortress.....	200

---

# FABRIC PROGRAM

Fabrics listed may have been discontinued or price changed since publishing.

## BURCH, CONTINUED

Foundation.....	200	Rivet.....	300
Full Circle.....	500	Rogue.....	200
Genesis.....	200	Rogue II.....	300
Gilded.....	300	San Remo.....	300
Glaze.....	300	Savanna.....	200
Grand Sierra.....	300	Seduction.....	300
Grand Vista.....	200	Sequins.....	300
Guardian.....	300	Silvertex.....	300
Guideline.....	300	Soho.....	200
Heidi.....	200	Solitaire.....	300
Heidi Soft.....	200	Spirit Millennium.....	300
Heritage (Nassimi).....	200	Sta-soft.....	300
Heritage (Omnova).....	300	Stratosphere.....	300
Hexx.....	200	Stucco.....	300
Hitch.....	300	Sundance.....	300
Hologram.....	200	Surfside/Stratford.....	300
Impression.....	400	Surrey.....	300
Independence.....	200	Synchronicity.....	300
Interlace.....	400	Token.....	400
Intrepid.....	300	Traveler.....	300
Invision.....	400	Twist.....	300
Islander.....	200	Universal.....	200
Kaleidoscope.....	400	Vector.....	300
Kimono.....	300	Venue.....	300
Kinetic.....	500	Vibe.....	200
Landscape.....	300	Vintage.....	300
Liberty.....	200	Virtue.....	300
Margin.....	400	Vista.....	300
Maverick.....	200	Vivo.....	300
Mimic.....	300	Whisper.....	300
Monticello.....	200	Wicker.....	300
Motive.....	200	Wired.....	300
Mulberry.....	500	Wish.....	300
Muse.....	300	Wonder.....	300
Natural Linen.....	300	Zodiac.....	300
Natural Movements.....	300		
Nauga Leather.....	300		
Nauga Soft.....	300		
Naugaform.....	400		
Naugahyde CP 1967 ..	300		
Naugasylk.....	300		
Navigator.....	200		
Neochrome III.....	300		
Nexus.....	300		
Origin.....	200		
Outback.....	300		
Oxen(Nassimi/Sprad)	200		
Oxen (Naugahyde).....	200		
Patriot.....	300		
Persuasion.....	200		
Phoenix.....	200		
Pioneer.....	300		
Polished.....	300		
Prizm.....	200		
Prodigy.....	200		
Promise.....	300		
Quill.....	200		
Quilted.....	400		
Rattan.....	300		
Reflex.....	300		
Refresh.....	300		
Renaissance.....	300		
Reptile.....	200		



CF STINSON

Acadia Epingle.....Call	Fleck.....300	Pinball.....500	VINYL & NON PVC	Sentry HC.....300
Ace.....300	Flex.....400	Pivot.....300	Abacus.....600	Shantung.....300
Acrobat.....600	Flight.....600	Polka.....300	Amplify.....200	Sirocco.....600
Adagio.....400	Flip Flops.....600	Portico.....400	Apex Crypton Revl.....400	Sleek.....300
Adirondack.....500	Florentine.....400	Posey.....500	Ardent.....300	Smile.....600
Aero.....400	Folio.....600	Posh.....400	Atlas.....200	Smoothie.....300
Alchemy.....500	Fractal.....600	Profile.....400	Avant.....300	Spirit Millennium.....300
Alfresco.....500	Full Turn.....600	Queue.....500	Bambu-EnVi.....500	Stat-Con.....500
Alignment.....600	Furrows.....300	Raquette.....500	Bistro.....200	Stitch in Time.....300
Anagram.....500	Gradation.....400	Realm.....400	Bon Voyage.....600	Strand.....300
Archer.....300	Gravity.....400	Recharge w/Celliant..600	Budget Black.....200	Stride.....300
Armature.....600	Hands On.....500	Refraction.....300	Burkshire.....300	Symphony Classic.....300
Artisan.....300	Handwork.....500	Retrograde.....300	Carlisle.....300	Tendrill.....300
Balance Beam.....600	Happy Tappy.....700	Revolution.....500	Cassablanca.....300	Tessuto.....300
Bali.....600	Haven.....500	Riddle.....300	Cassidy.....300	Vegas.....300
Basket.....700	Helix.....600	Ritz.....400	Catalyst.....300	Verdure-EnVi.....500
Bass Line.....500	Hi-Fi.....300	Salinas.....700	Channel.....300	Walk the Line.....600
Beatbox.....500	Highlight.....300	San Simeon.....700	Chroma.....400	Whisper.....300
Bespoke.....400	Hive.....300	Satellite.....400	Cirque.....300	Whitney.....400
Blip.....300	Hot Spot.....500	Seagrass.....600	Citadel.....300	Ziggy.....300
Block Party.....600	Hourglass.....600	Sebago.....500	Clean Slate.....300	Zodiac.....300
Bloom.....Call	Hush.....600	Sequence.....300	Colorguard.....200	
Bongo.....600	I Spy.....600	Shift.....300	Connect.....300	NON PVC
Boost w/Celliant.....600	Infinity Plush.....600	Shimmy.....400	Core.....200	Arioso.....500
Borderline.....600	Inside Track.....300	Sideline.....400	Criss Cross.....300	Camino.....Call
Breton.....600	Interval.....400	Skyline.....600	Dash.....300	Chaos.....700
Brilliant.....300	Isabella.....600	Sleeping Bear Dunes..500	Diva.....300	Cielo.....Call
Broadband.....600	Jambi Stripe.....500	Splash.....600	Dodgeball.....600	Corium.....500
Bryant Park.....300	Kennebunk.....600	Splice.....700	English Pub.....300	Dakota.....300
Calibration.....600	Kinetic.....500	Sprint.....300	Essential.....200	Effervescense.....600
Cannon Beach.....700	Knock Knock.....600	Square One.....300	Expressions.....300	Etch.....500
Catalina.....600	Knot.....500	Squire.....500	Fizz.....300	Galileo.....500
Celeste.....500	Lateral.....300	Stellar.....400	Frequency.....500	Glisten.....Call
Cinnamon Blossom.....600	Lifecycle.....600	Steppe.....600	Fuse.....200	Impress w/StakKleen..500
Circulate w/Celliant...500	Lift.....600	Stipple.....400	GeoMet.....400	Kid.....500
Cirro.....600	Luster.....500	Storyboard.....700	Grand Sierra.....300	Mesa.....Call
Coco.....500	Manchester.....400	Summit.....500	Glide.....300	Modena.....500
Colden.....600	Mandala.....500	Sunburst.....600	Kilkenny Tweed.....300	Moxie.....500
Color Block.....600	Marimba.....500	Supersillyness.....600	Kusari.....300	Sedona.....Call
Comeback.....600	Marquetry.....600	Swipe.....600	Laredo.....200	Silicone-Avail.....600
Concentric.....600	Maxwell.....300	Swivel.....600	Level.....400	Silicone-Max ONE.....700
Continuum.....400	Maze.....600	Symmetry.....600	Loophole.....400	Silverado w/Agion.....600
Converge.....600	Migration.....700	Tangram.....500	Matrix.....400	Solitaire.....300
Cottonwood.....500	Mingle.....600	Three60.....700	Mica.....300	Staple.....300
Cranbrook Loop.....Call	Moby.....300	Tidbit.....500	Moccasin.....200	Sundance w/StaKleen400
Crystalline.....600	Modernist.....700	Torus.....500	Montana.....300	Tender.....Call
Current.....600	Monhegan.....600	Tranquility.....600	Natural World.....600	Volterra-HC.....Call
Dart.....300	Montage.....400	Transcend.....300	Naugaleather.....300	Wyatt.....400
Deflection.....500	Nest.....600	Tribeca.....300	Naugasoft.....200	
Detail.....500	Network.....500	Trio.....600	Neochorme III.....300	CLODAGH
Division.....400	New Hempstead.....300	Tweed.....500	Nishiki.....300	Chakra.....600
Donegal.....500	Nimble.....500	Twiggy.....500	Orbit.....300	Deza.....600
Drizzle.....600	Nova.....400	Vanish.....600	Overlay.....400	Jala.....700
Duet.....500	Olivia.....300	Vapor.....600	Oxford.....300	Kambala.....600
Eddy.....700	Outlander.....300	Velocity.....500	Patriot Plus II.....300	Ketana.....600
Elderberry.....600	Pacifica.....600	Vermont.....600	Promenade.....500	
Enhance w/Celliant....600	Paradox.....600	View.....600	Raffia.....400	MICHAEL GRAVES
Equinox.....500	Park Avenue.....600	Voltage.....600	Rainier.....300	Grove.....500
Euclid.....300	Penelope.....500	Whirl.....600	Rally.....200	Sunswept.....500
Fast Lane.....300	Peninsula Mohair.....Call	Wish.....Call	Rialto.....300	Vineyard.....700
Fenestra.....600	Pergola.....500	Zoom.....500	Rogue II.....200	
Figment.....600	Perimeter.....400		Scout.....300	
Firefly.....600	Piccadilly.....500		Script.....300	

---

# FABRIC PROGRAM

Fabrics listed may have been discontinued or price changed since publishing.

## CF STINSON, CONTINUED

### PATTY MADDEN

Lucent..... 700  
Radiance..... 700

### ROBERT STERN

Acanthus..... 600  
Algiers..... 600  
Cyma..... 600  
Diffusion..... 700  
Oscillate..... 600  
Scintillate..... 600  
Spindles..... 600  
Stratford..... Call  
Tessellate..... 600

### DESIGNER

#### PERFORMANCE

Acanthus..... 600  
Algiers..... 600  
Cyma..... 600  
Diffusion..... 700  
Oscillate..... 600  
Scintillate..... 600  
Spindles..... 600  
Stratford..... Call  
Tessellate..... 600

#### GENUINE LEATHER

R.E.I.L..... Call

### MICHAEL GRAVES VINYL

Auberge..... 500  
Entrada..... 500  
Excursion..... 300  
Latitude..... 300  
Valise..... 300

### PATTY MADDEN VINYL

Affinity..... 500  
Aspen..... 500  
Banyan..... 500  
Bari..... 500  
Bubblerrake..... 600  
Capreni..... 500  
Chainite..... 600  
Eli..... 500  
Hashtag..... 500  
Juxy..... 500  
Lava..... 600  
Live Wire..... 500  
Martini..... 500  
Median..... 600  
Olympus..... 500  
Perspective..... 600  
Plexus..... 500  
Prisma..... 500  
Raya..... 600  
Revolve..... 600  
Ripple..... 600  
Rivera..... 500  
Seta..... 600  
Slightwave..... 500  
Vortexia..... 600  
Waterwand..... 600  
Wicker..... 500  
Winnly..... 400  
Ybor..... 500



## CAMIRA

24/7 .....	500
Aquarius.....	400
Blazer.....	500
Blazer Lite.....	400
Blazer Quilt	
Channel .....	600
Blazer Quilt	
Hourglass.....	600
Canopy.....	300
Chicago.....	300
Code.....	600
Craggan .....	600
Craggan Flax.....	600
Ebb .....	400
Era .....	300
Flow.....	400
Gravity.....	300
Halcyon Aspen .....	400
Halcyon Blossom.....	400
Halcyon Cedar.....	400
Halcyon Linden.....	400
Halcyon Poplar.....	400
Haven.....	300
Hebden .....	500
Hemp .....	500
Honeycomb.....	400
Individuo.....	500
Landscape Balance..	500
Landscape Contact...	500
Landscape Synergy...	500
Main Line Flax.....	500
Main Line Flax Stripe	500
Manhattan .....	300
Nettle Aztec.....	600
Nettle Nomad .....	600
Nettle Traveller .....	600
Nexus.....	300
Oxygen.....	400
Patina.....	400
Rivet.....	300
Silk.....	600
Sprint.....	300
Stripes.....	600
Synergy.....	500
Synergy Quilts.....	600
Touch .....	400
Track.....	500
Trail.....	500
Vintage .....	200
Zig Zag .....	600

# FABRIC PROGRAM

Fabrics listed may have been discontinued or price changed since publishing.

## DOUGLAS

A La Mode.....400	Chain Dot.....200	Entice.....200	Jolie.....400	Parlour.....200
Abacus.....300	Chakra.....400	Entwined.....400	Joseph.....200	Pasadena.....300
Acacia.....300	Chalet.....300	Envy.....200	Keen.....300	Passion.....200
Acadia.....300	Chamberlin.....400	Equal.....300	Kelso.....300	Pembroke.....300
Accessory.....300	Charm.....300	Escapade.....200	Kilim.....400	Pendulum.....200
Adams.....200	Chariot.....300	Escort.....200	Kirby.....300	Penobscot.....300
Adore.....300	Charleston.....400	Eternity.....200	Kismet.....300	Pentagon.....200
Allure.....200	Charlotte.....300	Excel.....200	Kyoto.....400	Pentel.....300
Amazement.....200	Charlotte.....300	Exemplar.....200	La Boheme.....300	Pepperell.....300
Amherst.....200	Chartes.....400	Extreme.....300	Lair.....300	Persia.....400
Applique.....300	Chateaux.....400	Fable.....300	Lascia.....400	Piazza.....200
Arbor.....300	Chi Chi.....300	Fanatic.....200	Lavish.....300	Picotage.....300
Archetype.....200	Chiaro.....400	Fascination.....200	Leaf.....400	Pied A Terre.....400
Arrondi.....300	Chronicle.....300	Fidget.....300	Linden.....200	Pilot.....200
Asana.....400	Cicely.....300	Fisher.....300	Linea.....300	Pincurl.....400
Ashbury.....300	Circuit.....200	Fizz.....200	Link.....200	Plantation.....300
Astute.....300	Cirque.....300	Flagstaff.....300	Lodge.....400	Pleat.....300
Atelier.....400	Clapham.....300	Flash.....400	Loft.....400	Pocasset.....300
Austin.....300	Clove.....300	Fling.....200	Loopy.....200	Pocomo.....300
Backgammon.....300	Club House.....400	Flip.....200	Lush.....300	Pomona.....300
Bainbridge.....300	Codger.....300	Florida Straits.....200	Malino.....400	Ponset.....300
Balance.....200	Cohansey.....200	Flounce.....300	Manga.....400	Portland.....300
Bandeau.....300	Columbia.....200	Flower Power.....300	Marigold.....400	Precedent.....200
Baskerville.....300	Compass.....300	Flutter.....200	Marisal.....400	Pressed Leaves.....400
Baslow.....400	Confetti.....400	Forage.....300	Marvel.....200	Preston.....300
Baste.....300	Converge.....300	Fortune.....300	Mayfair.....300	Primary.....200
Bauble.....300	Cornell.....200	Fountain.....400	Maze.....200	Princeton.....200
Bemberg.....300	Courage.....200	Foxy.....300	Mead.....300	Prisma.....300
Bendal.....300	Craftsman.....400	Frequent.....200	Mercer.....300	Provincial.....200
Bento.....400	Craze.....300	Frolic.....200	Millefleur.....400	Prudential.....300
Bergama.....400	Crisscross.....300	Frou Frou.....400	Mombasa.....300	Purdue.....200
Berkeley.....200	Crossroads.....400	Fuse.....300	Montmartre.....400	Puzzle.....300
Berman.....300	Curvaceous.....300	Gameboard.....400	Moulin.....400	Rabanna.....400
Beyond.....200	Cycle.....200	Gamut.....300	Moxie.....300	Rally.....300
Bimini.....200	Dainty.....400	Gauge.....200	Mungo.....300	Ramble.....400
Biscayne.....300	Dapper.....300	Getty.....300	Nairobi.....300	Random.....400
Bisous.....400	Dartmouth.....200	Glee.....200	Namaste.....400	Rappel.....200
Boat House.....400	Dayo.....300	Glide.....200	Nara.....400	Razor.....400
Bon Vivant.....300	Deck House.....400	Glint.....300	Natty.....300	Reality.....300
Bongani.....300	Del Mar.....200	Gorge.....300	Newel.....400	Recoil.....400
Botswana.....300	Deluxe.....300	Grace.....300	Newton.....300	Refined.....400
Boulevard.....400	Denali.....400	Gradient.....200	Nia.....300	Reflection.....400
Bounce.....200	Destiny.....300	Green House.....400	Nouvelle.....400	Reflex.....400
Branchport.....300	Domaine.....300	Greta.....300	Novel.....200	Reticulate.....400
Branco.....200	Drama.....200	Guild.....300	Numbers.....300	Reverb.....400
Brisk.....300	Dreamy.....200	Haiku.....400	Nuru.....300	Revere.....200
Bundle.....300	Droplet.....300	Hamlet.....200	Ogee.....400	Reversal.....400
Bungalow.....400	Duke.....200	Hancock.....200	OM.....400	Rhumba.....200
Bungee.....400	Duma.....300	Happenstance.....300	Oni.....300	Rhythm.....400
Burbank.....300	Duplex.....300	Harvard.....200	Optima.....300	Rickshaw.....400
Cabo.....200	Durango.....400	Haze.....400	Origami.....400	Rima.....300
Caboose.....400	Echelon.....200	Helena.....400	Orsay.....300	Ring.....200
Calibrate.....200	Echo.....200	Henry.....200	Paddle.....300	Ritzy.....300
Canal.....300	Edgy.....300	Herati.....400	Pagoda.....300	Rive Gauche.....400
Canopy.....300	Electricity.....200	Hewitt.....200	Palais.....400	Rolo.....300
Canson.....300	Electron.....200	Homestead.....400	Palmer.....300	Romance.....400
Cape Cod.....400	Elite.....200	Hoopla.....400	Palmyra.....300	Roundabout.....300
Carlyle.....300	Embassy.....200	Icon.....200	Pantheon.....200	Row.....300
Carriage House.....400	Embellish.....200	Impromptu.....200	Papiro.....300	Runway.....200
Cartwheel.....300	Emcee.....200	Incentive.....400	Parallel.....200	Sachet.....300
Castellani.....300	Endwise.....400	India.....400	Parasail.....200	Sandal.....400
Celeste.....300	Energize.....200	Jambo.....300	Parkside.....300	Sarong.....400
Centrum.....300	Enigma.....200	Jaunty.....300	Parliament.....200	Sassy.....300

DOUGLASS, CONTINUED

Satellite.....	300	Tamu.....	300	Aristo.....	300	Hackney.....	200	Seduction.....	300
Savile.....	300	Tanner Stripe.....	400	Aura.....	400	Hemingway.....	400	Sequins.....	300
Scoop.....	300	Tanzania.....	300	Ballistic.....	300	Heritage.....	200	Shagreen.....	300
Score.....	400	Taper.....	300	Bally.....	400	Hitch.....	300	Silvertex.....	300
Sendal.....	300	Tartaine.....	200	Baron.....	400	Huxley.....	400	Solino.....	300
Serendipity.....	300	Tea Leaves.....	300	Bayou.....	200	Hyde.....	200	Solitaire.....	300
Shawl.....	400	Tembo.....	300	Beckett.....	400	Impression.....	300	Spark.....	300
Shenandoah.....	300	Temple.....	200	Benjamin.....	300	Imprint.....	300	Spirit Millennium.....	300
Sherpa.....	200	Temp.....	300	Bergeret.....	400	Inclination.....	300	Spirit Supreme.....	300
Shiatsu.....	300	Terrace.....	500	Berwick Tweed.....	300	Independence 2.....	200	Spotlight.....	400
Shindig.....	200	Tetrus.....	200	Bomber.....	400	Indy.....	200	Stable.....	300
Shire.....	200	Token.....	300	Bongo.....	300	Interlace.....	300	Sta-Soft.....	200
Shoji.....	400	Tom's Garden.....	300	Bottega.....	200	Invision.....	300	Steel Pier.....	300
Shuffle.....	300	Touchstone.....	200	Bourbon Street.....	200	Jitter.....	400	Steps.....	300
Sidestep.....	300	Trail.....	400	Brink.....	300	Jive.....	400	Stipple.....	300
Siesta.....	300	Trapeze.....	300	Brisa.....	600	Kaleidoscope.....	300	Strada.....	500
Silk Road.....	400	Trapezoid.....	300	Brisa Distressed.....	700	Katana.....	400	Stratosphere.....	300
Simba.....	300	Tree House.....	400	Burkshire.....	300	Kernal.....	400	Surface.....	300
Siren.....	400	Trendsetter.....	300	Caesar.....	300	Kilkenny Tweed.....	300	Surfside.....	300
Skittle.....	300	Trifle.....	300	Caliber.....	200	Kiln.....	300	Surge.....	300
Slalom.....	300	Trinket.....	300	Canyon.....	200	Kimono.....	300	Surrey.....	300
Slide.....	200	Triumph.....	300	Capote.....	400	Kipper.....	400	Symphony.....	300
Soffit.....	300	Trotter.....	300	Casablanca.....	300	Kosta.....	400	Symphony Classic.....	200
Soiree.....	400	TV Land.....	300	Caso.....	200	Latch.....	300	Symphony Glaze.....	300
Solenoid.....	300	Tweed.....	300	Chadwick.....	200	Luxe.....	300	Symphony Lumina.....	400
Sophie.....	300	Twinkle.....	300	Chaise.....	400	Manco.....	400	Symphony Ultra.....	400
Sorti.....	300	Twirl.....	300	Chambray.....	300	Marble.....	300	Symphony Vintage.....	300
Soul.....	300	Twist.....	200	Chamea II.....	200	Marblestone.....	300	Synchronicity.....	300
Spartan.....	200	Twitter.....	200	Circus.....	400	Minuet.....	300	Taffy.....	200
Spencer.....	300	Usher.....	200	Clarke.....	400	Mirage.....	300	Tokio.....	300
Spiral.....	400	Utley.....	300	Claudet.....	400	Morey.....	300	Tolstoy.....	400
Spirograph.....	400	Utmost.....	200	Clutch.....	300	Morisot.....	400	Toscana.....	500
Spot.....	400	Utopia.....	200	Colorguard.....	200	Muse.....	300	Tram.....	300
Spout.....	200	Valle.....	300	Connect.....	200	Natural Linen.....	200	Traveler.....	300
Squire.....	200	Vanguard.....	300	Cork.....	400	Nauga Soft.....	200	Treasure.....	300
St. Germain.....	400	Versa.....	200	Cosmopolitan.....	300	NaugaLeather.....	300	Trex.....	200
Stacatto.....	200	Video.....	200	Courbet.....	400	Neochrome II.....	300	Twain.....	400
Stargaze.....	300	Viletta.....	300	Crafted Grids.....	300	New Duration.....	300	Twilight.....	300
Starlet.....	200	Vinea.....	400	Curio.....	200	Nuance.....	200	Twist.....	300
Static.....	400	Visa.....	400	Dauntless.....	200	Palm Harbor.....	300	Ultraleather.....	600
Stencil.....	400	Volute.....	300	Deville.....	400	Paris.....	300	Ultraleather Pro.....	700
Straightaway.....	300	Volute FR.....	300	Dimension.....	300	Patriot Plus.....	200	Universal.....	200
Strathmore.....	300	Wayfare.....	300	Discover.....	200	Pearlized.....	600	Valinda.....	300
Stryker.....	300	Wellesley.....	200	Dolce.....	300	Persuasion.....	200	Vdara.....	300
Stylish.....	300	Wiggle.....	400	Dumont.....	400	Phoenix.....	200	Vermillion.....	300
Suave.....	400	Windfall.....	300	Easel.....	200	Piano.....	400	Vermont.....	300
Suedegard.....	300	Wink.....	300	Eel.....	300	Plait.....	300	Verve.....	300
Summer House.....	500	Wish.....	400	Elm.....	300	Polo.....	300	Vibe.....	200
Sunshade.....	300	Witty.....	300	Emboss.....	200	Primera.....	500	Vicinity.....	300
Supreme.....	200	Woodland.....	200	English Pub.....	300	Promessa.....	700	Vitality.....	300
Surreal.....	200	Yale.....	200	Excaliber.....	200	Promise.....	300	Volley.....	300
Swahili.....	300	Yara.....	300	Expressions.....	300	Reflex.....	300	Whisper.....	200
Swank.....	300	Yoga.....	400	Faber.....	300	Renaissance.....	300	Wish.....	300
Swarthmore.....	200	Zanzibar.....	200	Fave.....	400	Render.....	200	Wonder.....	300
Swing.....	300	Zing.....	200	Ferris.....	300	Resort.....	300	Woven Hues.....	300
Swish.....	300	Zip Line.....	200	Flair.....	300	Riviera.....	300	Wynn.....	300
Switch.....	200	Zola.....	300	Fleck.....	200	Rouge II.....	200	Zodiac.....	300
Swizzle.....	300			Flume.....	300	Salinger.....	400		
Sylvia.....	300	VINYL		Foundation.....	200	San Remo.....	300		
Taboret.....	300	All-American.....	200	Funhouse.....	300	Savanna.....	200		
Tadala.....	300	Allante.....	200	Gillian.....	300	Scandia.....	200		
Tailor Made.....	300	Arc.....	300	Gouache.....	200	Seaquest.....	200		
Taj.....	400	Ardor.....	400	Grand Sierra.....	300	Seaquest RL 'N PLT.....	300		

# FABRIC PROGRAM

Fabrics listed may have been discontinued or price changed since publishing.

## MAHARAM

A Brand Apart.....Call	Chassis.....600	Epingle Stripe.....Call	Link.....700	Plait.....500
Abacus.....600	Checker.....Call	Equate.....600	Lithe.....600	Plume.....Call
Abacus Standard.....500	Checker Split.....Call	Exaggerated Plaid.....Call	Loop.....500	Ply Mesh Black/Tan.....Call
Across.....600	Chenille Cord.....Call	Exchange.....500	Lunar.....400	Pocket.....600
Aftermath.....Call	Chime.....500	Facets.....Call	Manner.....400	Point.....Call
Agency.....Call	Chock.....600	Fasten.....700	Marquee.....400	Pressed.....Call
Akimbo.....600	Chroma.....Call	Fathom.....400	Massive Paisley.....Call	Prime.....600
Albemarie.....Call	Circles.....Call	Feature.....600	Matrix.....Call	Quatrefoil.....Call
Alloy.....500	Circuit.....600	Floret.....600	Mechanism.....Call	Quay.....500
Alpaca Epingle.....Call	Clamber.....600	Fluent Crypton.....600	Medium.....400	Quell.....Call
Alpaca Herringbone.....Call	Clara.....600	Fluted Silk.....Call	Melange Tweed.....Call	Queue.....500
Alpaca Velvet.....Call	Coach Cloth.....Call	Flutter.....Call	Meld.....400	Quick.....500
Alter.....500	Coast.....500	Focus.....500	Memory.....700	Raas.....600
Anagram.....700	Coda.....Call	Fold.....600	Meridian.....600	Radiant.....Call
Apt.....700	Coin.....500	Foliage.....Call	Merit.....400	Recheck.....600
Arabesque.....Call	Coin Crypton.....600	Forest Nap.....500	Mesh.....Call	Reef.....Call
Arcade.....700	Coincide.....400	Fraction.....600	Messenger.....400	Reel.....700
Aria.....Call	Coincide HP.....600	Fruit.....Call	Metric.....400	Regatta.....700
Array.....600	Colline.....600	Furrow.....600	Micro.....500	Relay.....Call
Article.....400	Colorfield.....Call	Galaxy.....600	Mikado.....Call	Remix.....600
Assembled Check.....Call	Colorwheel.....Call	Garden.....Call	Milestone.....400	Repeat Classic.....Call
Balustrade.....700	Column.....600	Geometri.....Call	Millerstripe.....Call	Repeat Classic Print.....Call
Bander.....Call	Compartment.....Call	Gild.....500	Mimic.....700	Repeat Classic Stripe.....Call
Banister.....600	Compound.....600	Grade.....700	Mineral.....600	Repeat Dot.....Call
Bar.....500	Conduit.....400	Grid.....Call	Mingled Plaid.....Call	Repeat Dot Print.....Call
Bar Crypton.....600	Confetti.....Call	Grove.....600	Minicheck.....Call	Repeat Dot Ring.....Call
Basel.....600	Cotton Velvet.....Call	Hallingdal.....700	Minimal.....600	Rill.....500
Bavaria.....Call	Couple.....600	Hedge.....600	Mister.....700	Ring.....500
Bavaria Stripe.....Call	Crew.....600	Helix.....700	Mode.....400	Rise.....600
Beacon.....700	Crosspatch.....Call	Hero.....600	Mohair Extreme.....Call	Roster.....400
Beam.....600	Crush.....600	Herringbone Stripe.....Call	Mohair Supreme.....Call	Rove.....400
Beside.....600	Cursive.....700	Hewn.....Call	Molly.....600	Rule.....700
Bespoke Stripe.....Call	Cycle.....500	Horsehair Basket.....Call	Monk's Wool.....Call	Runner.....600
Bevel.....500	Dapper.....500	Horsehair Check.....Call	Mortise.....600	Runner Standard.....500
Big Stripe.....Call	Daring Sampler.....Call	Horsehair Striae.....Call	Motley.....500	Salon.....Call
Bind.....Call	Daring Larger.....Call	Houndstooth.....Call	Multiply.....400	Scope.....700
Bitmap.....500	Daring Plaid.....Call	Hours.....Call	Murmur.....400	Schema.....600
Blended Stripe.....Call	Dart.....600	Huddle.....Call	Muse.....300	Scuba.....500
Blip.....600	Decode.....600	Idle.....Call	Names.....Call	Scute.....500
Blocks.....Call	Deconstructed Rose.....Call	Imbue.....Call	Nestle.....Call	Scuttle.....500
Blumen.....Call	Design.....Call	Industry.....Call	Oblique.....400	Seam.....500
Borders.....Call	Dingbats.....Call	Inlay.....Call	Octave.....700	Segmented Stripe.....Call
Boundary.....500	Disc.....500	Insignia.....700	Offeset.....700	Sequence.....600
Bright Angle.....Call	Disc Crypton.....600	Instill.....500	Omen.....600	Sequential Stripe.....Call
Bright Cube.....Call	Ditto.....600	Jacobs Coat.....Call	Optik.....Call	Serif.....700
Bright Grid.....Call	Divide.....500	Joist.....Call	Orakelblume.....Call	Serried.....700
Brim.....700	Divide Crypton.....600	Keen.....500	Orbit.....400	Sheen.....600
Brindle.....400	Divina.....700	Kindred.....600	Ottoman Stripe.....Call	Shuttle Standard.....500
Brio.....600	Divina MD.....700	Knob.....Call	Painted Stripe.....Call	Signal.....600
Brushed Camel.....Call	Divina Melange.....700	Knot.....Call	Palio.....Call	Silk Canvas.....Call
Brushed Cashmere.....Call	Dot Pattern.....Call	Lanalux.....Call	Parched Silk.....Call	Skein.....500
Brushed Merino.....Call	Dots.....Call	Lariat.....400	Pare.....600	Slant.....600
Bureau.....400	Double Triangles.....Call	Latch.....700	Parquet.....700	Slumber.....Call
Candid.....500	Drape.....600	Layers Garden.....Call	Passel.....Call	Small Dot Pattern.....Call
Canvas.....600	Dwell.....400	Layers Park.....Call	Paver.....600	Soft Tweed.....Call
Caper.....400	Eden.....Call	Layers Vineyard.....Call	Pebble Wool.....Call	Sort.....500
Carapace.....Call	Edges.....Call	Lean.....500	Pebble Wood Multi.....Call	Span.....600
Cartouche.....600	Ellipsis.....600	Ledger.....500	Pennant.....600	Splay.....500
Cashmere Ripple.....Call	Embed.....600	Lens.....500	Pepper.....500	Spry.....500
Centric.....700	Emboss.....600	Letters.....Call	Periphery.....Call	Stack.....500
Chalet.....600	Emit.....400	Lift.....700	Pick.....400	Star.....Call
Chance.....600	Enmesh.....500	Limn.....Call	Pick Crypton.....600	Stature.....500
Chasm.....600	Entwine.....700	Lineage.....400	Pitch.....500	Steady.....500

## MAHARAM, CONTINUED

Steady Crypton.....	600	LEATHER
Steelcut .....	600	Bask.....Call
Steelcut Trio.....	700	Draft.....Call
Stick Tree.....	700	Hue.....Call
Stride.....	500	Loam.....Call
Strips .....	Call	Pace.....Call
Strum.....	600	Stark.....Call
Study .....	Call	Steep.....Call
Sudden .....	600	Tinge.....Call
Superweave .....	Call	Tuft.....Call
Surge.....	600	
Swivel .....	600	
Tally .....	600	
Tandem.....	500	
Tangram.....	Call	
Taper.....	Call	
Teatro.....	Call	
Technic .....	400	
Telary .....	Call	
Tend.....	600	
Terrace.....	600	
The Firm .....	Call	
The Story of My Life....	Call	
Ticker.....	600	
Tilt .....	600	
Tonica .....	600	
Tonus .....	600	
Toostripe .....	Call	
Tracery .....	Call	
Trait .....	600	
Transport.....	Call	
Tread.....	600	
Treat.....	600	
Trees.....	Call	
Trellis.....	600	
Trio .....	Call	
Trundle.....	400	
Twice .....	500	
Twill Weave.....	700	
Unisol.....	Call	
Urban .....	600	
Vases .....	Call	
Velvet Stripe.....	Call	
Venn.....	600	
Vestige .....	600	
Vineyard.....	Call	
Voyage.....	Call	
Waterborn.....	Call	
Waver.....	600	
Wedge.....	600	
Wend.....	500	
Whirl.....	500	
Wool Rib.....	Call	
Wool Striae.....	Call	
Wool Velvet.....	Call	
Wrap.....	500	

# FABRIC PROGRAM

Fabrics listed may have been discontinued or price changed since publishing.

## MAYER

Align.....300	Locomotion.....300	WOVEN CRYPTON	Vintage Mohair.....Call	Uptown.....300
Ankara.....400	Longitude.....300	Abbey.....300	Volante.....Call	Vinyl Stat ESD.....400
Artistry.....200	Lotus.....600	Acclaim.....300		Wallaby SP Black.....200
Ascension.....500	Madras.....300	Amadeus.....500	WOOL PATTERN	Willow.....300
Aurora.....500	Mandala.....700	Arabesque.....400	Geisha.....600	
Avenue.....500	Marmara.....400	Artistocrat.....400	Katagami.....600	FAUX LEATHER
Banner.....200	Matrix.....600	Big Top.....500	Obi.....500	Antique**.....300
Batik.....300	Meander.....300	Boro.....500	Origami.....600	Apollo Silicone.....600
Boteh.....700	Metal Strips.....500	Brio.....500	Samurai.....600	Berkshire.....400
Burst.....300	Milagro.....600	Celtic.....400	Shibori.....600	Bolero.....400
Camelot.....300	Monogram.....300	Cosmopolitan.....300	Wool Boucle.....600	Caressa FR.....300
Canvas.....400	Moonscape.....300	Crazy Quilt.....600		Cascade.....400
Cavalier.....200	Mosaic.....300	Cuddle Up.....500	VINYL	Cayman.....400
Charade.....400	Mosaic (Durablock)....400	Darning.....600	All Seasons FR.....200	Chequers.....400
Circuit.....600	Motif.....400	Debonair.....400	Apex.....300	Cork.....400
Circumference.....600	Nylon-Stat ESD.....500	Debut.....600	Aspect.....300	Counterpoint.....400
Collage.....600	Odesa.....400	Disco.....400	Atomic.....300	Durango.....300
Comalapa.....600	Optic.....200	Entourage.....500	Blocks.....300	Florentine.....200
Component.....200	Orbit.....300	Escapade.....400	Catwalk.....300	Glimmer.....400
Continuum.....200	Patio.....200	Fairy Tales.....500	Chaps FR.....300	Hombre.....400
Cross Check.....200	Pinnacle.....300	Fanfare.....600	Charette.....300	Jekyll & Hyde**.....300
Dapper.....200	Plaza.....400	Finale.....300	Cirque.....300	Kobe.....300
Daydream.....300	Polygon.....300	Fretwork.....600	Contempo.....300	Laredo.....400
Dazzle.....400	Portal.....300	Habitat.....300	Curlicue.....300	Longhorn.....400
Destiny.....300	Prism.....200	Holiday.....400	Dakota.....300	Makore.....400
Destiny (Durablock) ..400	Quattro.....200	Jitterbug.....400	Dande.....300	Maverick.....200
Detail.....400	Reflector.....500	Journey.....400	Dublin Tweed FR.....300	Milano.....300
Duraweave 10.....200	Rejuvenate.....500	Kantha.....500	Entwine.....300	Niche.....400
Echo.....300	Reverb.....300	Kensington.....300	Essence.....300	Outback.....300
Ecosphere.....400	Sequel.....200	Lavish.....400	Etch.....300	Palermo.....400
Element.....200	Sequel (Duralock).....300	London.....400	Finesse.....300	Patent.....400
Elevation.....400	Shantung.....300	Malibu.....400	Gala.....300	Phoenix.....300
Ephesus.....400	Sherlock.....300	Mayfair.....400	Galveston.....300	Ranchero.....200
Equation.....300	Signs.....600	New Dimensions.....600	Guardian.....300	Rift.....400
Equinox.....300	Soleil.....500	Nirvana.....500	Images.....300	Shimmer.....400
Erode.....600	Sophisticate.....300	Nostalgia.....400	Imprint.....300	Splendor.....400
Esprit.....300	Source.....300	Obsession.....600	Interlace.....300	Verona.....300
Essex.....300	Source (Durablock)....400	On the Spot.....400	Interlochen.....300	Zen.....500
Europa.....300	Spacer Mesh.....200	Paparazzi.....500	Key Largo.....200	
Evolve.....500	Spokes.....500	Pastime.....400	Linen.....300	
Facets.....500	Sula.....600	Positive Thoughts.....500	Links.....300	
Fedora.....200	Suna.....600	Primo.....400	Madrid SP Black.....200	
Figure Eight.....200	Sutra.....500	Rain Dance.....400	Matka.....300	
Flock.....600	Synapse.....500	Razzmatazz.....500	Microdot.....300	
Flower Power.....300	Theory.....200	Replay.....500	Mingle.....300	
Focal Point.....300	Twister.....300	Reveal.....400	Mode.....400	
Forte.....200	Valet.....300	Round 'N Round.....500	Morse.....400	
Foundation 10.....200	Variant.....200	Saori.....600	Neo.....300	
Genesis.....300	Venue.....300	Social Network.....300	Noble.....300	
Genesis (Durablock) ..400	Vibrant.....300	Soho.....400	Oxen SP Black.....200	
Groundwork.....400	Vipassana.....500	Tattersall.....400	Peerless.....300	
Haarlem.....600	Vogue.....300	Timeline.....300	Pinehurst.....300	
Haberdash.....300	Whirligig.....600	Viewpoint.....500	Prado.....300	
Hexagon.....300	Wildflower.....600	Whimsy.....600	Punch.....300	
Hoopla.....300	Wilson.....500	Xanadu.....500	Score.....400	
Huipil.....500	Zazen.....500		Sequence.....300	
In The Groove.....300		LUCIA CASA	Sierra SP Black.....200	
Infinity.....500	C-ZERO PATTERN	Array.....400	Silk Screen.....300	
Intrigue.....300	Boro.....500	Botanica.....400	Silverweave.....300	
Jenga.....300	Crazy Quilt.....600	Ottoman.....500	Sketch.....300	
Jubilee.....300	Darning.....600	Sakura.....600	Slick.....300	
Karma.....500	Kantha.....500	Sashiko.....500	Toss Up.....300	
Kismet.....400	Saori.....600	Turnabout.....500	Tributary.....300	
Latitude.....400		Venetian.....Call	Tussah.....300	

\*\* These patterns are designed to simulate natural leather that features shade variations and 'beauty marks' formed from wrinkles, stretch marks and usage. These effects are purposefully intended to mimic those of real leather and are not defects in the product.

### LEATHER

Butte.....Call  
Cheyenne.....Call  
Laramie.....Call

MOMENTUM

3d Grid.....	700	Geo.....	700	Pursue.....	600	Effloresce.....	700	Silica Deflect.....	700
Ace.....	300	Glide.....	500	Quince.....	600	Elevate.....	700	Silica Effloresce.....	700
Aldo.....	700	Graph.....	300	Rally.....	600	Elle.....	600	Silica Etc.....	700
Allegory.....	600	Grid.....	300	Refract.....	600	Etude.....	700	Silica Etch.....	700
Amenity II.....	600	Guild.....	300	Reveal.....	700	Evolve.....	600	Silica Fiona.....	700
Amuse.....	400	Habit.....	300	Revolve.....	600	Faux Felt.....	400	Silica Flick.....	700
April.....	400	Hearsay.....	600	Riga.....	600	Faux Mo.....	500	Silica Fresco.....	700
Arrange.....	600	Helm.....	500	Ring.....	600	Flock.....	400	Silica Fritz.....	700
Audio.....	600	Hop.....	500	Rise.....	300	Gatsby.....	600	Silica Gadget.....	700
Audubon.....	600	Hue.....	300	Rivet.....	300	Hobnob.....	400	Silica Hiatus.....	700
Avenue.....	300	Infinity.....	300	Rubato.....	600	Hula.....	600	Silica Hoop.....	700
Bandwidth II.....	500	Insight.....	200	Rush Hour.....	600	Infusion.....	500	Silica Jig.....	700
Bangle.....	200	Interim.....	600	Sail.....	600	Isla.....	400	Silica Kip.....	700
Banter.....	600	Interlock.....	700	Scan.....	600	Jest.....	500	Silica Leather.....	700
Beep.....	300	Intermix II.....	400	Scrabble.....	300	Kayak.....	700	Silica Likely.....	700
Bento.....	600	Jardin.....	600	Siteline.....	700	Keynote.....	400	Silica Motive.....	700
Bias.....	600	Jitney.....	500	Sketching Air.....	700	Mensa.....	600	Silica Reach.....	700
Bloc.....	600	Jot.....	300	Skip.....	300	Oath.....	500	Silica Roam.....	700
Bobby.....	300	Journal.....	600	Slice.....	300	Phase.....	700	Silica Scout.....	700
Boom II.....	400	Kindle.....	500	Small Talk.....	600	Recollection II.....	600	Silica Spoke.....	700
Boxcar.....	600	Kinney.....	300	Solace.....	300	Reverb.....	700	Silica Strata.....	700
Brisk.....	600	Knack.....	300	Sort.....	600	Roster.....	600	Silica Stride.....	700
Buoy.....	600	Kudos.....	600	Spontaneous.....	700	Spin.....	600	Silica Tech.....	700
Cairns.....	700	Ledge.....	400	Starboard.....	600	Sport.....	400	Silica Thatch.....	700
Camber.....	600	Lella.....	600	Story.....	600	Sway II.....	500	Silica Today.....	700
Carlo.....	700	Lens.....	300	Stroll.....	300	Synergy.....	500	Silica Triad.....	700
Centric.....	600	Level.....	500	Strut.....	400	Tag.....	600	Silica Waltz.....	700
Chipper.....	600	Lina.....	700	Symbol.....	700	Torque.....	700	Silica Wifi.....	700
Chromatic.....	600	Lineup.....	300	Syntax.....	300	Trefoil.....	500	Silica Wifi.....	700
Cityscape.....	700	Livia.....	700	Tactic.....	600	Viva II.....	500	Sublime II.....	400
Clang.....	300	Lloyd.....	700	Tech Weave.....	Call	Waver.....	400	Tact II.....	600
Colorwheel.....	500	Lore.....	600	Tesla.....	600	Zola.....	600	Tetra.....	300
Core.....	200	Lucio.....	Call	Tilt.....	500			Velocity.....	400
Course.....	600	Ludwig.....	700	Toggle.....	300	VINYL		Whit.....	400
Croquet.....	600	Malmo.....	600	Traction.....	700	Acoustic.....	600	Zipped.....	600
Crossing Colors.....	700	Mapping Ideas.....	700	Tradition.....	300	Agora II.....	400		
Cryptic.....	600	Marathon.....	300	Trapeze.....	600	Archer.....	600		
Cube.....	600	Marcel.....	700	Trivia.....	600	Beeline.....	400		
Current.....	300	Medley.....	400	Trove.....	600	Bravo II.....	400		
Cutout.....	700	Memory.....	700	Turin.....	600	Canter.....	300		
Dart.....	300	Millennium.....	300	Twist.....	600	Cashmere II.....	300		
Dash.....	600	Mix.....	600	Uplift.....	500	Cycle.....	400		
Dayspell.....	600	Nagoya.....	600	Veer.....	500	Echo II.....	600		
Decode.....	300	Neon.....	600	Via.....	300	Endurance Epu.....	300		
Delve.....	500	Nimble.....	600	Vox.....	200	Eon.....	300		
Dive.....	500	Odyssey.....	300	Wander.....	600	Foray.....	400		
Drawing Lines.....	600	Ohs II.....	700	Weaving.....	600	Fringe.....	400		
Drift.....	600	Origin.....	300	Well Well Well.....	Call	Groove.....	400		
Ebb.....	600	Painting.....	600	Whim.....	500	Halo.....	600		
Edison.....	600	Panorama.....	600	Why Why Why.....	700	Hive.....	500		
Embark.....	500	Parable.....	500			Icon.....	500		
Epic.....	300	Parentesi.....	700	CRYPTON		Kindred.....	500		
Essay.....	600	Parenthesis.....	300	Align.....	600	Leno.....	600		
Estrella.....	600	Perk.....	200	Almanac.....	600	Nifty.....	300		
Explore.....	600	Photon.....	600	Analog.....	600	Rein II.....	400		
Expo.....	200	Phrase.....	600	Ardour II.....	600	Row.....	400		
Fleet.....	500	Pierre.....	700	Ascend.....	400	Sidestep.....	600		
Float.....	300	Ping.....	400	Avanti.....	600	Silica.....	700		
Flow.....	600	Pique.....	300	Byways.....	600	Silica Andy.....	700		
Flux.....	600	Places Spaces.....	700	Central.....	400	Silica Arc.....	700		
Focal.....	300	Propel.....	600	Channel.....	400	Silica Bracket.....	700		
Fold.....	700	Propensity II.....	300	Cover Cloth.....	400	Silica Checker.....	700		
Free.....	300	Prospect.....	400	Docket.....	600	Silica Compass.....	700		
Fuse.....	300	Proximity.....	600	Domain.....	400	Silica Cusp.....	700		

# A BETTER CHAIR

Building a better chair starts with using only the finest domestic raw materials, employing skillfully trained craftsman, and close monitoring of the production process. In addition, we integrate consistent features in our products so they uniquely last a lifetime.

## CONSTRUCTION

Joinery is a combination of dowel or mortise and tenon with additional hardened steel fasteners to provide the highest quality frame.



Interlocking corner block and rail joint lends superior strength at critical joints and provides optimum support for the seat suspension. This provides more durability and comfort for the life of the chair. All chair frames are reinforced with screws, not just glue, for rigidity and durability. Solid wood corner blocks provide support at all critical joints.



Depending on frame style, certain models feature our bolt & slug metal fastener for extra seat strength and durability. Seats are attached to frame with the bolt & slug fastener through front, back and side rails for structural joint construction that lasts a lifetime. We never attach through the corner block which weakens the joint structure and reduces the life and performance of a chair.

Other frame styles use our hardened steel confirmat metal fastener for extra seat strength and durability. Seats are attached to frame with the confirmat fastener through back and side rails for structural joint construction that lasts a lifetime. We never attach through the corner block which weakens the joint structure and reduces the life and performance of a chair.

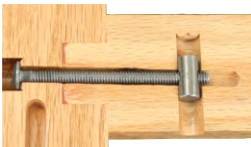

Select upholstered styles utilize a flex-o-lator spring suspension for extra support and comfort, and reduces wear on the cushion and fabric for long term performance.



There are no shortcuts involved in building a chair to last a lifetime. Therefore, we build every chair from scratch, under our roof. From drying raw lumber to final cartoning, we self-perform all stages of building our furniture, so we can fully stand behind what we sell.

## MANUFACTURING

Each year we purchase over two billion board feet of the finest Northern grown red oak and hard maple harvested within the United States. We work with responsible foresters located within the Midwest to ensure quality and availability.

This is where we stand out from the rest. Our lumber is stored up to a year, dried (yes, right here ourselves), graded, and sorted accordingly. Unlike many manufacturers that bypass this vital process for faster methods or purchase dried lumber. Starting with rawest of materials is how we've always done it and we haven't changed a bit.

Few contract seating companies practice the craft of steam bending, but we have mastered the process to bring more authentic beauty and structural integrity for chairs that last a lifetime. Steam bending allows the grain to follow the curve eliminating short grain inferiority inherent in bandsaw construction. To begin the steam bending process, we saturate chair components to precise pliability, steam bend into various shapes, and dry to a stable moisture content for years of solid comfort with high traffic use.

Relying on the finest machinery from around the world, we are able to build our product quickly, accurately, and to the highest possible quality.

Constant quality checks are made throughout the assembly process. Frame assembly is controlled to secure proper fit and form.

Before receiving the final sanding, every chair is inspected to ensure the proper amount of glue was used and each frame is square and fastened properly. During the sanding process we flush out joints and create smoothness in preparation for finish.

Each chair is put through numerous straining and sanding processes for smoothness. Multiple layers of catalyzed varnish are applied. Chairs then pass through several temperature controlled ovens to cure the finish for ultimate durability.

Material is precisely cut, measured, and upholstered. A final inspection to ensure consistency of the order and all quality standards are met. Then, product is securely packaged and prepared for shipping.

The old way never gets old.





# ORDERING

## KEY

### BASE MODEL

- US upholstered seat
- UB upholstered backrest
- UBS upholstered seat and backrest
- BS barstool
- S stool
- SB sled base

### FUNCTIONAL OPTIONS

- CA casters
- MO motion seat
- ST stacking
- UA upholstered arm pad
- BA bariatric
- HH handhold
- RTA tablet arm
- HB high back
- GHH ganging hardware

### DECORATIVE FEATURES

- NT nail trim
- C circle cutout
- 3C three circle cutout
- TC square cutout
- 3S three square cutout
- L line cutout
- 3L three line cutout
- DS decorative stitching
- CB cosmetic buttons

## GUIDELINES

All orders must be written and clearly state quantity, model number, wood species, finish selection, fabric selection, expected delivery date, and shipping address to be entered. Within a maximum of five days, an acknowledgment is provided. It is the customer's responsibility to check the accuracy of all information.

Submit orders to:

Email  
orders@jasperchair.com

Online  
jasperchair.com/resources/quotes-and-ordering

Mail  
Jasper Chair  
534 E 8th Street  
Jasper, IN 47546

## NEW ACCOUNTS

To expedite the process, please fill out the new account form in its entirety. The form is available from your local representative, Customer Service or online at [jasperchair.com/resources/quotes-and-ordering](http://jasperchair.com/resources/quotes-and-ordering).

## ORDERING EXAMPLES

Model numbers represent basic style, size and type of chair. The numbers within a model strand indicate most similar product, families. Additional designators are built into the model number and indicate functional and decorative options. These are outlined in above key.

To order chairs and stools, specify:

1. Core model number, indicating seat height when needed
2. Wood specie
3. Wood finish color
4. Fabric selection, including vendor, pattern and color
5. Options, such as glides, casters, nail trim, channels, etc

105US | Oak | Cordovan | Mayer | Saucy | Blue | NT | CA  
(1) (2) (3) (4) (4) (4) (5) (5)

To order lounge, specify:

1. Core model number, indicating seat span when needed
2. Arm style
3. Wood specie
4. Wood finish color
5. Fabric selection, including vendor, pattern and color
6. Options, such as ganging, etc

5710-2 | WS | Oak | Cordovan | Mayer | Saucy | Blue  
(1) (2) (3) (4) (5) (5) (5)

To order tables, specify:

1. Core model number, indicating size and shape
2. Edge selection and profile
3. Leg or base style
4. Wood specie
5. Wood finish color
6. Laminate selection, include vendor, pattern, and color

L42RP29 | D | S | Oak | Cordovan | Wilsonart | Graphite | Nebula  
(1) (2) (3) (4) (5) (6) (6) (6)



# TERMS

## **PRICING**

All prices shown are list and are F.O.B. factory. Effective price lists supersede any and all prices previously quoted and are subject to change. Jasper Chair will only honor pricing from an effective price list or a valid written quote.

## **FREIGHT ESTIMATES**

Freight estimates are approximated costs and are subject to change within 30 days of a written quote. Please contact our Customer Service for confirmed or revised pricing.

## **ORDERS**

All orders must clearly state the quantity, model number, wood species, finish selection, fabric selection if applicable, expected delivery date, and shipping address to be entered. It is the responsibility of the company placing the order to supply Jasper Chair with all the necessary information. We accept no liability for an incomplete order. Incomplete orders cannot be entered and cannot be scheduled into production until all the necessary information is received. If you place an order with Jasper Chair and do not receive an order acknowledgment within five business days, please contact the factory.

## **ACKNOWLEDGMENTS**

Order acknowledgments are sent the same day the order is entered. Please review the acknowledgment and contact the factory within 48 hours of receipt if corrections are necessary. Later changes will be subject to factory approval and possible charges depending on the status of the order. Orders being processed in two weeks or less will not be allowed to change after the order is entered.

## **ORDER AMENDMENTS**

Amendments to an entered order must be done in writing. There may be charges assessed depending on the status of the order.

## **CANCELLATIONS**

Cancellation of an order must be done in writing. There may be charges assessed depending on the status of the order. Orders specifying a custom finish may not be canceled once the finish process is underway.

## **SHIPMENTS**

Jasper Chair will select a quality carrier with the best possible freight rate unless a carrier has been specified in writing on the order. If a dealer selects the carrier, Jasper Chair cannot be held liable for any damages that occur to said shipment.

## **FREIGHT CLAIMS**

All shipments are delivered to the carrier in good condition and our liability ceases thereafter. Please inspect all shipments upon receipt and note any shortages or damages on the bill of lading. If the shipment arrives damaged or short, and Jasper Chair has chosen the carrier, you must notify the factory within 7 days of receipt of the shipment. However, if the carrier is one of your own choosing, you should file a claim immediately with the carrier. Failure to file a claim within 7 days after receipt of the shipment constitutes acceptance and a waiver of any possible claim.

## **RETURNS & REPAIRS**

All returns must be factory authorized and must be shipped freight prepaid. Any shipment returned unauthorized or freight collect will be refused. Upon receipt of the returned product, Jasper Chair will determine whether the product is defective. Liability for defective products is limited to repair or replacement. There will be no credit issued for returned product.

## **REPLACEMENT PARTS**

Please contact your factory service person for help and pricing concerning replacement parts.

## **WARRANTY**

Each piece of furniture manufactured by Jasper Chair is warranted to the original purchaser to be free from defects in material or those resulting from workmanship for a period of five years. All swivel controls, glides, casters, and fabrics are warranted by their respective manufacturers based on their conditions. This warranty does not apply to damage resulting from misuse or accident. Warranty claims must be in writing and Jasper Chair will determine whether to repair or replace the defective product.

# CARE & MAINTENANCE

Periodic inspections should be made to determine if the wood surface is soiled. If so, clean using a mild household cleaner and damp cloth. The wood finish is resistant to body oils and perspiration, but should be cleaned when a soiled condition is noticeable.

Should ink, lead, or paint soil the wood finish, immediately refer to the manufacturer's recommendations for cleaning from a varnish or a painted surface.

If the surface becomes scratched, use a touch-up material compatible with varnish. Do not use any lacquer type materials, as this will cause the finish to lift or blister.

When the upholstery fabric becomes soiled, use a name brand fabric cleaner or shampoo as per the manufacturer's instructions. Should the fabric be soiled with ink, lead, or paint, immediately refer to the manufacturer's recommendations to remove.

Chair frame maintenance requires periodic inspections of the joints, especially the back post to side rail joint. Check to be sure all screws

are tight and if any screws have become loosened; tighten. Should any part of the chair frame develop a crack or break, immediately remove the chair from use and contact a qualified furniture repair person or contact the factory for assistance.

Wood is greatly affected by moisture or more importantly the lack of moisture. The best relative humidity ranges between 35 to 45 percent at 70 to 80 degrees Fahrenheit. If your building's relative humidity level is below 35 percent, a system that adds moisture into the air needs to be employed. The worst time of year for moisture related troubles is during the winter as heating systems extract moisture from the air. Chairs with solid wood seats are very sensitive to drops in humidity. The solid wood chair seat will be the first part of the chair to show signs of lack of moisture and develop small end grain checks or splits. Should this occur, please check to see if the relative humidity level in your building is at the proper level.

Should any unusual problem occur, contact the factory or a factory representative for assistance.



**cheers!**



DESIGN  
CENTER



---

# SOLUTIONS



We strive to make the process of selecting and purchasing furniture fun and easy. Find out more with our start-to-finish guide.

## **COLLABORATIVE PLANNING**

We are ready to listen, so let's start with the basics - your goal and concepts, budgetary parameters, and a time line. We're probably just as excited as you to see your brand come to life.

## **PROJECT MANAGEMENT**

A project manager will be here to ease the flow of communication, time objectives, and even follow up after the product installs. Or, years later, a replacement part is needed or you're looking to expand, we'll have project details and be ready to go.

## **DESIGN & ENGINEERING**

Now for selecting product. We have many standard options and many more custom solutions. Whether it's an inspiration concept, sketch, or a drawing, we can accommodate. Our team of experts have ideas on construction techniques and value engineering.

## **SAMPLES**

We realize details matter. We will provide drawing files with full specifications or even a rendered visual. And, when time allows, let's mock up a prototype and be certain all those details are precise.

## **STOCKING**

We're happy to accommodate inventory and management of, whether its fully boxed and ready-to-ship or maintaining inventory based upon forecasting efforts. We realize the importance of being on time and have adequate warehouse space to provide this service at no added cost to you. We'd rather have product under our roof than multiple handling or some warehouse unaccounted.

## **ONGOING**

We are committed to your goals and our partnership. If you have a need or an idea, we are ready to hear it - replacement seats or cushions, touch-up, charcuterie boards, and special product packaging - and everything in between. We want to ensure your satisfaction throughout the entire process, including years after.

Jasper Chair provides a variety of solutions for many applications. Following is a guide to what we see trending in these environments.

**RESTAURANT, HOTELS & RESORTS**

Dining has evolved into an experiential event and interiors are critical to a restaurant or hotel's success. Jasper Chair services many world wide food and stay facilities and have become a go-to source due to our customization and superior quality.

Popular selections *Allis, Brooks, Dakota, Hana, Hays, Joliet, Neenah, Niles, Samara, Walton*

**CAFE, COFFEE HOUSE, & WINERY/BREWERY**

Smaller scale seats, vintage appeal, or finish selections, Jasper Chair provides options to meet the distinct look with a variety of choices.

Popular selections *Addi, Afton, Clay, Diego, Lora, Macy, Marshal, Porter*

**HOUSING COMPLEX**

Get a look for right at home with our contract grade product and competitive pricing, our chairs fit a variety of spaces while meeting budgets.

Popular selections *Diego, Hana, Koko, Lora, Macy, Samara*

**CRUISE SHIPS**

Jasper Chair offers selections made specifically for cruise ships. With an eye on sizes, arm and armless, and designs that fit contemporary and traditional themes.

Popular selections *Neenah, Niles, Samara, Sidney*

**COUNTRY CLUBS, ARENAS, AND STADIUM SUITES**

Casters, club chairs, and customization make our offering right for most any recreational area. Add a logo or team color for that extra brand element.

Popular selections *Becket, Brooks, Diego, Hays, Koko, Mckinley, Samara*

**SENIOR LIVING & HEALTHCARE**

A unique responsibility comes with furnishing senior living and healthcare facilities. Above all else, furniture must be attractive, comfortable, and supportive. Every product is crafted and upholstered

to provide these elements for a long day's wait.

Popular selections *Chelsey, Dolton, Lenexa, Niles, Novi, Tinley*

**LIBRARY**

Whether a public library or law library, our full range of coordinating collections have distinction and functionality for these spaces.

Popular selections *Asher, Becket, Clive, Edina, Ellanor, Lydia*

**OFFICE**

Let our product work for you. Looks for start ups to refined details, create an atmosphere for millennial to boomers.

Popular selections *Diego, Hana, Koko, Milan, Neenah, Samara*

**EDUCATION & STUDENT HOUSING**

A top choice with distinction and durability for the rigorous demands of students. Jasper Chair provides solutions to many higher education campuses and k-12 institutions.

Popular selections *Diego, Macy, Marshal, Taylor, Tinley, Walton*

**RELIGIOUS**

Custom kneelers, the warmth of wood, or linking, allow your place of worship unity and the functionality it needs.

Popular selections *Diego, Edina, Lyons, Tiffin, Tinley*

**RETAIL**

Let's create product that supports your brand. A first look or comfort for waiting, our chairs are sure to impress your audiences.

Popular selections *Joliet, Macy, Samara*

**SPECIALTY FEATURES**

Stacking *Asher, Chelsey, Diego, Novi, Tinley*

Bariatric *Novi*

4-leg Casters *Mckinley*

Mixed Material *Diego, Brooks*

Juvenile *Clive, Edina, Marshal, Taylor, Tiffin, Walton*

Linking *Clive, Taylor, Tiffin, Tinley*

**CUSTOM PRODUCT**

Jasper Chair is your most reliable source for authentic custom manufacturing. From a slight modification such as made-to-measure dimensions to building a completely original concept, Jasper Chair, in partnership with you, will masterly craft the exact product.

Leg design, stretchers and support rails, edge treatment, seat style, upholstery techniques, functional features such as stacking or kneelers, materials are just a few ways to make your product your own.

**QUANTITIES**

Due to the nature of creating a unique piece, minimum order quantities apply. Please contact Customer Service for specific details and parameters. A general guide, is fifty chair minimum; however,

depending on previous designs and programming, this can vary, or a one time fee can be applied.

**LEAD TIME**

We will make every effort to accommodate your lead time schedule. Due to the extra time involved with engineering efforts, an increase of two weeks can be expected to create a unique furniture piece.

**REQUEST**

To minimize the time frame, please provide at the onset of a customer project - project reference, quantities, ship to zip, detailed product information, contact name and information.

# TAILOR MADE

Because every project is unique, we allow a variety of ways to personalize your project. Here's a look at our most popular options. Not all options are available on all product with standard pricing. Upcharges may apply.



## PERSONALIZED LASER ENGRAVING

Provide art file or inspiration, specification of color, size and location; available on many seats and backrests.



## MULTI-FINISH

Select product can be specified in choice of two finish colors.



## DUAL UPHOLSTERY

Specify many models in a choice of two upholstery selections; outside of backrest or between seat and backrest are most common.



## NAIL TRIM

Standard trim is in brass at 1/2" spacing; antique, satin, and oxford are also available; spacing can be without gaps or at 1" or more increments.



## FINISH COLORS

By providing color specification (paint or pms values), we can match nearly any variety.



## FINISH APPLICATION

Rubbed color, distressing or other unique application, provide your inspiration and we can execute.



## DECORATIVE CUTOUTS

Offer on a variety of standard geometric cutouts and options; if you have another idea, provide an art file or instructions.



## DECORATIVE STITCHING

Want a little extra detail added to upholstered product, add stitching. Our standard options are line or grid, but we do a variety of other techniques.



## MOTION SEATS \*

Motion seats are designed in our Brooks collection and many additional barstools; with some modifications, many others can utilize this feature.



## JURY BASE

Available as a standard option with our Walden collection.



## ARMPADS

Armpads can be added to a variety of models; we route the shape into the arm to fit the pads securely. Novi and McKinley offer as a standard option.



## LINKING

A variety of lounge, chair, and sled base models offer linking.

\* Motion seats, while providing a unique feature, may require additional attention. Due to movement, the chair or stool's backrest can bump along table and counter tops, causing damage. A solution for this instance would be to include a footrail along the table or bar to keep the backrest apart from the surface.





**HANDHOLDS**

Porter offers an integrated and rounded handhold option; many series include cutout designs.



**CASTERS**

Many chairs include the option to add front leg casters; Mckinley allows for four leg casters.



**BUTTONS & TUFTING**

Want a little extra detail added to upholstered product, add buttons or a tufting detail.



**BOOKSHELF**

Looking for added functionality of a bookshelf? Look no more. Several series utilize a bookshelf stretcher system. Or, apply to the backrests of a variety of chairs.

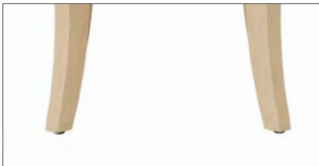

**GLIDES**

Rubber cushion chrome glides are standard; we recommend and offer a .875" black or white nylon for wood and tile floor application.



**CHANNELS & RINGS**

Barstools are standard with brass channels and rings; stainless and other color options are available.



**SEAT HEIGHT & DIMENSIONS**

Many barstools can be modified to counter height; other product allows for height adjustment as well - cafe size, juvenile, lounge or other.



**PERSONALIZED STAMPING**

A process to express your brand message; provide an art file or inspiration, color and size specifications.



**REPLACEMENT SEATS & PARTS**

Due to high traffic environments and the longevity of our product, replace seats or other parts may be needed; many of our products allow this feature with ease.



**PIPING**

A welt cord or piping creates defined form and added protection to furniture. Specify in coordinating or dual upholstery selection.



7933US.BS.30.C.....	47 & 141	1600.BS.30.....	53 & 145	541UBS.TC.....	58 & 149	S693US.24.....	66 & 155	174.3.P.SB.....	97 & 160
7963.....	47 & 141	1600.BS.24.....	53 & 145	543US.....	58 & 149	SIDNEY		175.....	73 & 162
7963UB.....	47 & 141	1600US.BS.30.....	53 & 145	543UBS.....	58 & 149	611.....	67 & 156	175UB.....	73 & 162
7963US.....	47 & 141	1600US.BS.24.....	53 & 145	543US.BS.30.....	58 & 149	613.....	67 & 156	175US.....	73 & 162
7963UBS.....	47 & 141	1700.....	53 & 145	543US.BS.24.....	58 & 149	613.BS.30.....	67 & 156	175UBS.....	72 & 162
7983.....	47 & 141	1700US.....	53 & 145	543UBS.BS.30.....	58 & 149	613.BS.24.....	67 & 156	3.175.....	73 & 162
7983US.....	47 & 141	1700.BS.30.....	53 & 145	543UBS.BS.24.....	58 & 149	615.....	67 & 156	3.175UB.....	73 & 162
7983UBS.....	47 & 141	1700.BS.24.....	53 & 145	543US.TC.....	58 & 149			3.175US.....	73 & 162
		1700US.BS.30.....	53 & 145	543UBS.TC.....	58 & 149	STIKA		3.175UBS.....	73 & 162
MACY		1700US.BS.24.....	53 & 145	543US.BS.30.TC.....	58 & 149	641.....	68 & 157	177.18.....	72 & 162
R.623.18.....	94 & 143	1800.....	50 & 144	543US.BS.24.TC.....	58 & 149	643.....	68 & 157	177UB.18.....	73 & 162
R.623.24.....	94 & 143	1800US.....	51 & 144	543UBS.BS.30.TC.....	58 & 149	643.BS.30.....	68 & 157	177US.18.....	73 & 162
R.623.36.....	94 & 143	1800.BS.30.....	50 & 144	543UBS.BS.24.TC.....	58 & 149	643.BS.24.....	68 & 157	177UBS.18.....	73 & 162
833.....	49 & 142	1800.BS.24.....	51 & 144	545US.....	57 & 148	647.....	69 & 157	177.16.....	73 & 162
953.....	48 & 142	1800US.BS.30.....	51 & 144	545UBS.....	57 & 148	647.....	69 & 157	177UB.16.....	73 & 162
953.L.....	94 & 143	1800US.BS.24.....	51 & 144	547US.....	56 & 148	647.BS.30.....	69 & 157	177US.16.....	73 & 162
S.9802.30.....	49 & 142	1900.....	51 & 144	547UBS.....	57 & 148	647.BS.24.....	69 & 157	177UBS.16.....	73 & 162
9803.BS.24.....	49 & 142	1900US.....	51 & 144	547US.BS.30.....	56 & 148	649.....	69 & 157	3.177.18.....	73 & 162
9803.BS.30.....	48 & 142	1900.BS.30.....	51 & 144	547US.BS.24.....	57 & 148			3.177UB.18.....	73 & 162
9805.BS.24.....	49 & 142	1900.BS.24.....	51 & 144	547UBS.BS.30.....	57 & 148	TAYLOR		3.177US.18.....	73 & 162
9805.BS.30.....	49 & 142	1900US.BS.30.....	51 & 144	547UBS.BS.24.....	57 & 148	841.....	97 & 163	3.177UBS.18.....	73 & 162
S.9808.30.....	49 & 142	1900US.BS.24.....	51 & 144			84.2.....	97 & 163	773.SB.28.....	70 & 159
		9556.....	50 & 144	NILES		84.3.....	97 & 163	773UB.SB.28.....	71 & 159
		9556US.....	51 & 144	551US.....	59 & 150	841.SB.....	97 & 163	773US.SB.28.....	71 & 159
MARSHAL		9556.C.....	51 & 144	551UBS.....	59 & 150	84.2.SB.....	97 & 163	773UBS.SB.28.....	71 & 159
433.18.....	53 & 145	9556US.C.....	51 & 144	553US.....	59 & 150	84.3.SB.....	97 & 163	S.773.16.....	71 & 158
433US.18.....	53 & 145	9556.3C.....	51 & 144	553UBS.....	59 & 150	86.....	97 & 163	S.773US.16.....	71 & 158
433UBS.18.....	53 & 145	9556US.3C.....	51 & 144	553US.BS.30.....	59 & 150	86.SB.....	97 & 163	S.773US.SB.16.....	71 & 159
433.16.....	53 & 145	9556.BS.30.....	50 & 144	553US.BS.24.....	59 & 150	86.SB.W.....	97 & 163	S.773US.SB.16.....	71 & 159
433US.16.....	53 & 145	9556.BS.24.....	51 & 144	553UBS.BS.30.....	59 & 150	86.W.....	97 & 163	S.773.18.....	71 & 158
433UBS.16.....	53 & 145	9556US.BS.30.....	51 & 144	553UBS.BS.24.....	59 & 150	171.SB.....	73 & 162	S.773US.18.....	71 & 158
433.BS.30.....	53 & 145	9556US.BS.24.....	51 & 144			171UB.SB.....	73 & 162	S.773.SB.18.....	71 & 159
433.BS.24.....	53 & 145	9556.BS.30.C.....	51 & 144	NOVI		171US.SB.....	73 & 162	S.773US.SB.18.....	71 & 159
433US.BS.30.....	53 & 145	9556US.BS.30.C.....	51 & 144	7301UBS.....	61 & 151	171UBS.SB.....	72 & 162	S.773.28.....	71 & 158
433US.BS.24.....	53 & 145	9556.BS.30.3C.....	51 & 144	7301UBS.BA.....	61 & 151	171.....	73 & 161	S.773US.28.....	71 & 158
433UBS.BS.30.....	53 & 145	9556US.BS.30.3C.....	51 & 144	7303UBS.....	60 & 151	171UB.....	73 & 161	S.773.SB.28.....	71 & 159
433UBS.BS.24.....	53 & 145			7303UBS.BS.30.....	60 & 151	171US.....	73 & 161	S.773US.SB.28.....	71 & 159
435.18.....	53 & 145	MCKINLEY		7303UBS.BS.24.....	61 & 151	171UBS.....	73 & 161	776.18.....	71 & 158
435UB.18.....	53 & 145	1301.....	54 & 146	7303UBS.BA.....	61 & 151	172UBS.....	73 & 161	776UB.18.....	71 & 158
435US.18.....	53 & 145	1302.BS.30.....	54 & 146	7305UBS.ST.....	60 & 151	173.SB.18.....	73 & 162	776US.18.....	71 & 158
435.16.....	52 & 145	1302.BS.24.....	54 & 146			173UB.SB.18.....	73 & 162	776UBS.18.....	71 & 158
435UB.16.....	53 & 145	1303.....	54 & 146	OAKLEY		173US.SB.18.....	73 & 162	776.SB.18.....	70 & 159
435US.16.....	53 & 145	1303.BS.30.....	54 & 146	320.1.....	95 & 152	173UBS.SB.18.....	72 & 162	776UB.SB.18.....	71 & 159
435UBS.16.....	53 & 145	1303.BS.24.....	54 & 146	320.2.....	95 & 152	173.SB.16.....	73 & 162	776US.SB.18.....	71 & 159
435.BS.30.....	53 & 145	1304.BS.30.....	54 & 146	320.3.....	95 & 152	173UB.SB.16.....	73 & 162	776UBS.SB.18.....	71 & 159
435UB.BS.30.....	53 & 145	1304.BS.2.....	54 & 146	320.2424US.18.....	95 & 152	173US.SB.16.....	73 & 162	776.16.....	71 & 158
435US.BS.30.....	53 & 145	1305.....	54 & 146	320.2448US.18.....	95 & 152	173UBS.SB.16.....	73 & 162	776UB.16.....	71 & 158
435UBS.BS.30.....	53 & 145	1307.....	54 & 146	L.320.2424P18.....	103 & 152	173.18.....	73 & 161	776US.16.....	71 & 158
436.....	53 & 145	1307.BS.30.....	54 & 146	L.320.2448P18.....	103 & 152	173UB.18.....	73 & 161	776UBS.16.....	71 & 158
436US.....	53 & 145	1307.BS.24.....	54 & 146	L.3203232P18.....	103 & 152	173US.18.....	73 & 161	776.14.....	71 & 158
436.C.....	52 & 145					173UBS.18.....	73 & 161	776UB.14.....	71 & 158
436US.C.....	53 & 145	MILAN		PORTER		173.16.....	73 & 161	776US.144.....	71 & 158
436.BS.30.....	53 & 145	7833US.....	55 & 147	863.....	62 & 153	173UB.16.....	73 & 161	776UBS.14.....	71 & 158
436.BS.24.....	53 & 145	7833US.BS.30.....	55 & 147	863US.....	63 & 153	173US.16.....	73 & 161	776.SB.16.....	71 & 159
436US.BS.30.....	52 & 145	7833US.BS.24.....	55 & 147	863UBS.....	62 & 153	173UBS.16.....	73 & 161	776UB.SB.16.....	71 & 159
436US.BS.24.....	53 & 145	S.7933US.30.....	55 & 147	863UBS.HH.....	62 & 153	174.1.....	96 & 160	776US.SB.16.....	71 & 159
436.BS.30.C.....	53 & 145	S.7933US.24.....	55 & 147			174.2.....	97 & 160	776UBS.SB.16.....	71 & 159
436.BS.24.C.....	53 & 145			SAMARA		174.3.....	96 & 160	776.SB.14.....	71 & 159
436US.BS.30.C.....	53 & 145	NEENAH		835.....	64 & 154	174.1.P.....	97 & 160	776UB.SB.14.....	71 & 159
436US.BS.24.C.....	53 & 145	531US.....	57 & 148	839.BS.30.....	64 & 154	174.2.P.....	97 & 160	776US.SB.14.....	71 & 159
436.3C.....	53 & 145	533US.....	57 & 148			174.3.P.....	97 & 160	776UBS.SB.14.....	71 & 159
436US.3C.....	53 & 145	533US.BS.30.....	57 & 148	SELINA		174.1.SB.....	97 & 160	777UBS.....	70 & 158
436.BS.30.3C.....	53 & 145	533US.BS.24.....	57 & 148	693.....	66 & 155	174.2.SB.....	97 & 160	778US.....	71 & 158
436US.BS.30.3C.....	53 & 145	541US.....	58 & 149	693.BS.24.....	66 & 155	174.3.SB.....	97 & 160	778UBS.....	71 & 158
1600.....	53 & 145	541UBS.....	58 & 149	693.BS.30.....	66 & 155	174.1.P.SB.....	97 & 160	778US.SB.....	71 & 159
1600US.....	53 & 145	541US.TC.....	58 & 149	S693US.30.....	66 & 155	174.2.P.SB.....	97 & 160	778UBS.SB.....	70 & 159

# INDEX

L80.2424P18.....	103, 163, 167	11.96.3.....	98 & 167	107US.....	79 & 169	L.4242P29.....	105 & 174
L80.2448P18.....	103, 163, 167	11.96.1.P.....	98 & 167	107.BS.30.....	79 & 169	L.4848P29.....	105 & 174
L80.3232P18.....	103, 163, 167	11.96.2.P.....	98 & 167	107US.BS.30.....	79 & 169	L.36RP29.....	105 & 174
L8036RP18.....	103, 163, 167	11.96.3.P.....	98 & 167	108.18.....	79 & 169	L.42RP29.....	104 & 174
TIFFIN		11.96.1.SB.....	98 & 167	108US.18.....	79 & 169	L.48RP29.....	105 & 174
971.....	75 & 164	11.96.2.SB.....	98 & 167	108.16.....	79 & 170		
971UB.....	75 & 164	11.96.3.SB.....	98 & 167	108US.16.....	79 & 170	MULTI-FUNCTIONAL TABLES	
971US.....	75 & 164	11.96.1.P.SB.....	98 & 167	108.14.....	79 & 170	2430.....	107 & 175
971UBS.....	75 & 164	11.96.2.P.SB.....	98 & 167	108US.14.....	79 & 170	2436.....	107 & 175
971.SB.....	75 & 165	11.96.3.P.SB.....	98 & 167	133.....	79 & 170	3036.....	107 & 175
971UB.SB.....	75 & 165	TINLEY		133.RTA.....	79 & 170	3048.....	107 & 175
971US.SB.....	75 & 165	2200.20.....	76 & 168	500.....	79 & 170	3660.....	106 & 175
971UBS.SB.....	74 & 165	2200UB.20.....	77 & 168	500US.....	79 & 170	3672.....	107 & 175
973.18.....	75 & 164	2200US.20.....	77 & 168	501.....	79 & 169	2424.....	107 & 175
973UB.18.....	75 & 164	2200UBS.20.....	77 & 168	501US.....	79 & 169	3030.....	107 & 175
973US.18.....	75 & 164	2200.20.BS.30.....	76 & 168	502.....	79 & 170	3636.....	107 & 175
973UBS.18.....	75 & 164	2200UB.20.BS.30.....	77 & 168	502US.....	79 & 170	4242.....	107 & 175
973.SB.18.....	74 & 165	2200US.20.BS.30.....	77 & 168	503US.....	79 & 169	4848.....	107 & 175
973UB.SB.18.....	75 & 165	2200UBS.20.BS.30.....	77 & 168	503.BS.30.....	79 & 169	24R.....	107 & 175
973US.SB.18.....	75 & 165	2202.20.....	77 & 168	503US.BS.30.....	79 & 169	30R.....	106 & 175
973UBS.SB.18.....	75 & 165	2202UB.20.....	77 & 168	506.....	79 & 169	36R.....	107 & 175
S.973.18.....	75 & 164	2202US.20.....	77 & 168	506US.....	79 & 169	42R.....	107 & 175
S.973US.18.....	75 & 164	2202UBS.20.....	77 & 168	506UB.....	81 & 171	48R.....	107 & 175
S.973.SB.18.....	75 & 165	2203.20.....	77 & 168	506UBS.....	81 & 171		
S.973US.SB.18.....	75 & 165	2203UB.20.....	77 & 168	507.....	79 & 169		
973.16.....	75 & 164	2203US.20.....	77 & 168	507US.....	79 & 169		
973UB.16.....	75 & 164	2203UBS.20.....	77 & 168	507UB.....	81 & 171		
973US.16.....	75 & 164	2204.20.....	77 & 168	507UBS.....	81 & 171		
973UBS.16.....	75 & 164	2204UB.20.....	77 & 168	507UB.BS.30.....	81 & 171		
973.14.....	75 & 164	2204US.20.....	77 & 168	507UBS.BS.30.....	81 & 171		
973UB.14.....	75 & 164	2204UBS.20.....	77 & 168	508.18.....	79 & 169		
973US.14.....	75 & 164	WALTON		508US.18.....	79 & 169		
973UBS.14.....	75 & 164	51.....	80 & 171	508.16.....	79 & 170		
973.SB.16.....	75 & 165	51US.....	81 & 171	508US.16.....	79 & 170		
973UB.SB.16.....	75 & 165	53.18.....	80 & 171	508.14.....	79 & 170		
973US.SB.16.....	75 & 165	53US.18.....	81 & 171	508US.14.....	79 & 170		
973UBS.SB.16.....	75 & 165	53US.16.....	81 & 171	509.2.....	100 & 170		
973.SB.14.....	75 & 165	53.BS.30.....	81 & 171	509US.2.....	100 & 170		
973UB.SB.14.....	75 & 165	53US.BS.30.....	80 & 171	509.3.....	100 & 170		
973US.SB.14.....	75 & 165	57.18.....	81 & 171	509US.3.....	100 & 170		
973UBS.SB.14.....	75 & 165	57US.18.....	81 & 171	WARREN			
S.973.16.....	75 & 164	57.BS.30.....	81 & 171	118.....	82 & 172		
S.973US.16.....	75 & 164	57US.BS.30.....	81 & 171	118US.....	82 & 172		
S.973.SB.16.....	75 & 165	100.....	79 & 170	124.....	82 & 172		
S.973US.SB.16.....	75 & 165	100US.....	79 & 170	124US.....	82 & 172		
973.SB.28.....	75 & 165	102.....	79 & 170	130.....	82 & 172		
973UB.SB.28.....	75 & 165	102US.....	79 & 170	130US.....	82 & 172		
973US.SB.28.....	75 & 165	102.BS.30.....	79 & 169				
973UBS.SB.28.....	74 & 165	102US.BS.30.....	79 & 169				
S.973.SB.28.....	75 & 165	103.....	78 & 169				
S.973US.SB.28.....	75 & 165	103US.....	79 & 169				
977.18.....	75 & 166	103.RTA.....	78 & 170				
977UB.18.....	75 & 166	103.BS.30.....	78 & 169				
977US.18.....	75 & 166	103US.BS.30.....	78 & 169				
977UBS.18.....	75 & 166	103.BS.24.....	78 & 169				
977.16.....	75 & 166	103US.BS.24.....	78 & 169				
977UB.16.....	75 & 166	103/503.....	79 & 169				
977US.16.....	75 & 166	103/503.RTA.....	79 & 170				
977UBS.16.....	75 & 166	104.....	78 & 169				
3.977.18.....	75 & 166	104US.....	79 & 169				
3.977UB.18.....	75 & 166	105.....	79 & 169				
3.977US.18.....	75 & 166	105US.....	79 & 169				
3.977UBS.18.....	75 & 166	107.....	79 & 169				
11.96.1.....	98 & 167						
11.96.2.....	98 & 167						

# THE EARTH'S FRIEND FOR NINETY SIX YEARS.

Jasper Chair's environmentally conscious approach is a necessary part of how we do business. We have responsibly handled and managed wood raw materials for ninety-six years and counting, so a great amount of present and future accountability for our natural resources has guided our environmental ethic for decades. We make it our absolute commitment to harvest wood in a way that preserves and replenishes our forests. Our products are designed to last a lifetime. Close attention is paid to the way our furniture is made and to the ways it can be renewed, reused, and recycled.

Jasper Chair makes its furniture with the intent it will be heirloom furniture passed from generation to generation. Continually investing in the most modern technology and equipment ensures maximum lumber yield and improves manufacturing efficiency. We collect all non usable wood and use it for fuel, creating steam for manufacturing processes and heat in the winter, reducing the release of damaging fossil fuels in our facilities and into the air. We promote company wide efforts and employ environmental stewards, delivering protective methods to benefit future generations with our conscientious, sound manufacturing practices.



**JASPER CHAIR**  
**534 E 8TH STREET**  
**JASPER, IN 47546**  
**812.482.5239**

**[JASPERCHAIR.COM](http://JASPERCHAIR.COM)**